

# Hazelcast IMDG 3.11.2 Reference Manual

Hazelcast IMDG Reference Manual .....	1
Preface .....	1
Hazelcast IMDG Editions .....	1
Hazelcast IMDG Architecture .....	1
Hazelcast IMDG Plugins .....	2
Licensing .....	2
Trademarks .....	3
Customer Support .....	3
Release Notes .....	3
Contributing to Hazelcast IMDG .....	3
Partners .....	3
Phone Home .....	3
1. Document Revision History .....	5
2. Getting Started .....	7
2.1. Installation .....	7
2.1.1. Installing Hazelcast IMDG .....	7
2.1.2. Installing Hazelcast IMDG Enterprise .....	8
2.1.3. Setting the License Key .....	8
License Key Format .....	10
2.1.4. License Information .....	10
JMX .....	10
REST .....	10
Logs .....	11
2.2. Supported Java Virtual Machines .....	12
2.3. Running in Modular Java .....	13
2.4. Upgrading from 3.x .....	14
2.5. Upgrading from 2.x .....	16
2.6. Starting the Member and Client .....	18
2.7. Using the Scripts In The Package .....	21
2.8. Deploying On Amazon EC2 .....	21
2.9. Deploying On Microsoft Azure .....	21
2.10. Deploying On Pivotal Cloud Foundry .....	21
2.11. Deploying using Docker .....	22
3. Hazelcast Overview .....	22
3.1. Sharding in Hazelcast .....	23
3.2. Hazelcast Topology .....	23
3.3. Why Hazelcast? .....	25
3.4. Data Partitioning .....	27

3.4.1. How the Data is Partitioned .....	29
3.4.2. Partition Table .....	29
3.4.3. Repartitioning .....	29
3.5. Use Cases .....	30
3.6. Resources .....	30
4. Understanding Configuration .....	30
4.1. Configuring Declaratively .....	31
4.1.1. Composing Declarative Configuration .....	32
4.2. Configuring Programmatically .....	34
4.3. Configuring with System Properties .....	35
4.4. Configuring within Spring Context .....	36
4.5. Dynamically Adding Data Structure Configuration on a Cluster .....	37
4.5.1. Handling Configuration Conflicts .....	38
4.6. Checking Configuration .....	38
4.7. Configuration Pattern Matcher .....	39
4.8. Using Wildcards .....	39
4.9. Using Variables .....	41
4.10. Variable Replacers .....	42
4.10.1. EncryptionReplacer .....	43
4.10.2. PropertyReplacer .....	44
4.10.3. Implementing Custom Replacers .....	45
5. Setting Up Clusters .....	45
5.1. Discovery Mechanisms .....	45
5.1.1. TCP .....	45
5.1.2. Multicast .....	45
5.1.3. AWS Cloud Discovery .....	46
5.1.4. GCP Cloud Discovery .....	46
5.1.5. Apache jclouds® Cloud Discovery .....	46
5.1.6. Azure Cloud Discovery .....	46
5.1.7. Zookeeper Cloud Discovery .....	46
5.1.8. Consul Cloud Discovery .....	46
5.1.9. etcd Cloud Discovery .....	46
5.1.10. Hazelcast for PCF .....	47
5.1.11. Hazelcast OpenShift Integration .....	47
5.1.12. Eureka Cloud Discovery .....	47
5.1.13. Heroku Cloud Discovery .....	47
5.1.14. Kubernetes Cloud Discovery .....	47
5.2. Discovering Members by TCP .....	48
5.3. Discovering Members by Multicast .....	49
5.4. Discovering Native Clients .....	50
5.5. Creating Cluster Groups .....	51

5.5.1. Cluster Groups before Hazelcast 3.8.2	52
5.6. Member User Code Deployment - BETA	52
5.6.1. Configuring User Code Deployment	53
5.6.2. Example for Filtering Members	54
5.7. Client User Code Deployment - BETA	55
5.7.1. Configuring Client User Code Deployment	55
Important to Know	56
5.7.2. Adding User Library to CLASSPATH	57
5.8. Partition Group Configuration	59
5.8.1. Grouping Types	60
HOST_AWARE	60
CUSTOM	60
PER_MEMBER	61
ZONE_AWARE	62
SPI	62
5.9. Logging Configuration	63
5.9.1. Example Log4j2 Configuration	65
5.9.2. Example Log4j Configuration	66
5.10. Other Network Configurations	67
5.10.1. Public Address	67
5.10.2. Port	68
5.10.3. Outbound Ports	68
5.10.4. Reuse Address	69
5.10.5. Join	70
multicast element	71
tcp-ip element	71
aws element	72
discovery-strategies element	72
5.10.6. AWSClient Configuration	72
5.10.7. Interfaces	73
5.10.8. IPv6 Support	74
5.10.9. Member Address Provider SPI	75
5.11. Failure Detector Configuration	76
5.11.1. Deadline Failure Detector	77
5.11.2. Phi Accrual Failure Detector	78
5.11.3. Ping Failure Detector	79
Requirements and Linux/Unix Configuration	80
6. Rolling Member Upgrades	82
6.1. Terminology	82
6.2. Hazelcast Members Compatibility Guarantees	83
6.3. Rolling Upgrade Procedure	83

6.4. Network Partitions and Rolling Upgrades .....	84
6.5. Rolling Upgrade FAQ .....	85
7. Distributed Data Structures .....	86
7.1. Overview of Hazelcast Distributed Objects .....	87
7.1.1. Loading and Destroying a Distributed Object .....	88
7.1.2. Controlling Partitions .....	89
7.1.3. Common Features of all Hazelcast Data Structures .....	89
7.1.4. Example Distributed Object Code .....	89
7.2. Map .....	90
7.2.1. Getting a Map and Putting an Entry .....	90
7.2.2. Creating A Member for Map Backup .....	92
7.2.3. Backing Up Maps .....	93
Creating Sync Backups .....	93
Creating Async Backups .....	94
Enabling Backup Reads .....	94
7.2.4. Map Eviction .....	95
Understanding Map Eviction .....	95
Configuring Map Eviction .....	96
Example Eviction Configurations .....	99
Evicting Specific Entries .....	99
Evicting All Entries .....	100
Forced Eviction .....	100
Custom Eviction Policy .....	101
7.2.5. Setting In-Memory Format .....	103
7.2.6. Using High-Density Memory Store with Map .....	103
Required configuration changes when using NATIVE .....	104
7.2.7. Loading and Storing Persistent Data .....	105
Using Read-Through Persistence .....	107
Setting Write-Through Persistence .....	107
Setting Write-Behind Persistence .....	108
Storing Entries to Multiple Maps .....	109
Initializing Map on Startup .....	110
Loading Keys Incrementally .....	111
Forcing All Keys To Be Loaded .....	111
Post-Processing Objects in Map Store .....	112
Accessing a Database Using Properties .....	112
7.2.8. Creating Near Cache for Map .....	113
7.2.9. Locking Maps .....	113
Pessimistic Locking .....	114
Optimistic Locking .....	115
Pessimistic vs. Optimistic Locking .....	116

Solving the ABA Problem .....	117
Lock Split-Brain Protection with Pessimistic Locking .....	117
7.2.10. Accessing Entry Statistics .....	118
7.2.11. Map Listener .....	118
7.2.12. Listening to Map Entries with Predicates .....	118
7.2.13. Removing Map Entries in Bulk with Predicates .....	121
7.2.14. Adding Interceptors .....	121
7.2.15. Preventing Out of Memory Exceptions .....	123
Setting Query Result Size Limit .....	124
Local Pre-check .....	124
Scope of Result Size Limit .....	124
Configuring Query Result Size .....	125
7.3. Queue .....	125
7.3.1. Getting a Queue and Putting Items .....	125
7.3.2. Creating an Example Queue .....	126
Putting Items on the Queue .....	126
Taking Items off the Queue .....	127
Balancing the Queue Operations .....	127
ItemIDs When Offering Items .....	128
7.3.3. Setting a Bounded Queue .....	128
7.3.4. Queueing with Persistent Datastore .....	129
7.3.5. Split-Brain Protection for Queue .....	131
7.3.6. Configuring Queue .....	132
7.4. MultiMap .....	133
7.4.1. Getting a MultiMap and Putting an Entry .....	134
7.4.2. Configuring MultiMap .....	134
7.4.3. Split-Brain Protection for MultiMap and TransactionalMultiMap .....	135
7.5. Set .....	137
7.5.1. Getting a Set and Putting Items .....	137
7.5.2. Configuring Set .....	138
7.5.3. Split-Brain Protection for ISet and TransactionalSet .....	138
7.6. List .....	139
7.6.1. Getting a List and Putting Items .....	140
7.6.2. Configuring List .....	140
7.6.3. Split-Brain Protection for IList and TransactionalList .....	141
7.7. Ringbuffer .....	143
7.7.1. Getting a Ringbuffer and Reading Items .....	143
7.7.2. Adding Items to a Ringbuffer .....	143
7.7.3. IQueue vs. Ringbuffer .....	143
7.7.4. Configuring Ringbuffer Capacity .....	144
7.7.5. Backing Up Ringbuffer .....	144

7.7.6. Configuring Ringbuffer Time-To-Live .....	144
7.7.7. Setting Ringbuffer Overflow Policy .....	145
7.7.8. Ringbuffer with Persistent Datastore .....	146
7.7.9. Configuring Ringbuffer In-Memory Format .....	148
7.7.10. Configuring Split-Brain Protection for Ringbuffer .....	148
7.7.11. Adding Batched Items .....	149
7.7.12. Reading Batched Items .....	149
7.7.13. Using Async Methods .....	151
7.7.14. Ringbuffer Configuration Examples .....	152
7.8. Topic .....	152
7.8.1. Getting a Topic and Publishing Messages .....	153
7.8.2. Getting Topic Statistics .....	153
7.8.3. Understanding Topic Behavior .....	154
Ordering Messages as Published .....	154
Ordering Messages for Members .....	155
Keeping Generated and Published Order the Same .....	155
7.8.4. Configuring Topic .....	155
7.9. Reliable Topic .....	157
7.9.1. Slow Consumers .....	159
7.9.2. Configuring Reliable Topic .....	159
7.10. Lock .....	160
7.10.1. Using Try-Catch Blocks with Locks .....	160
7.10.2. Releasing Locks with tryLock Timeout .....	160
7.10.3. Avoiding Waiting Threads with Lease Time .....	161
7.10.4. Understanding Lock Behavior .....	161
ILock vs. IMap.lock .....	162
7.10.5. Synchronizing Threads with ICondition .....	162
7.10.6. Split-Brain Protection for Lock .....	163
7.10.7. Lock Configuration .....	164
7.11. IAtomicLong .....	164
7.11.1. Sending Functions to IAtomicLong .....	165
7.11.2. Executing Functions on IAtomicLong .....	165
7.11.3. Reasons to Use Functions with IAtomic .....	166
7.11.4. Split-Brain Protection for IAtomicLong .....	166
7.12. ISemaphore .....	168
7.12.1. Controlling Thread Counts with Permits .....	168
7.12.2. Example Semaphore Code .....	168
7.12.3. Configuring Semaphore .....	170
7.12.4. Split-Brain Protection for ISemaphore .....	170
7.13. IAtomicReference .....	171
7.13.1. Sending Functions to IAtomicReference .....	171

7.13.2. Using IAtomicReference .....	172
7.13.3. Split-Brain Protection for IAtomicReference .....	172
7.14. ICountDownLatch .....	173
7.14.1. Gate-Keeping Concurrent Activities .....	173
7.14.2. Recovering From Failure .....	174
7.14.3. Using ICountDownLatch .....	175
7.14.4. Split-Brain Protection for ICountDownLatch .....	175
7.15. PN Counter .....	175
7.15.1. Configuring PN Counter .....	177
7.15.2. Configuring the CRDT replication mechanism .....	178
7.16. IdGenerator .....	179
7.16.1. Generating Cluster-Wide IDs .....	179
7.16.2. Unique IDs and Duplicate IDs .....	180
7.16.3. Migrating to FlakeIdGenerator .....	180
7.17. FlakeIdGenerator .....	180
7.17.1. Generating Cluster-Wide IDs .....	180
7.17.2. Performance .....	181
7.17.3. Example .....	181
7.17.4. Node ID Assignment .....	181
Node ID Overflow .....	182
7.18. Replicated Map .....	182
7.18.1. Replicating Instead of Partitioning .....	182
7.18.2. Example Replicated Map Code .....	183
7.18.3. Considerations for Replicated Map .....	183
7.18.4. Configuration Design for Replicated Map .....	184
7.18.5. Configuring Replicated Map .....	184
In-Memory Format on Replicated Map .....	186
7.18.6. Using EntryListener on Replicated Map .....	186
Difference in EntryListener on Replicated Map .....	186
Example of Replicated Map EntryListener .....	186
7.18.7. Split-Brain Protection for Replicated Map .....	187
7.19. Cardinality Estimator Service .....	188
7.19.1. Split-Brain Protection for Cardinality Estimator .....	189
7.20. Event Journal .....	191
7.20.1. Interaction with Evictions and Expiration for IMap .....	191
7.20.2. Configuring Event Journal Capacity .....	191
7.20.3. Event Journal Partitioning .....	193
7.20.4. Configuring Event Journal time-to-live .....	193
8. Distributed Events .....	193
8.1. Cluster Events .....	194
8.1.1. Listening for Member Events .....	194

Registering Membership Listeners .....	195
8.1.2. Listening for Distributed Object Events .....	196
Registering Distributed Object Listeners .....	197
8.1.3. Listening for Migration Events .....	197
Registering Migration Listeners .....	198
8.1.4. Listening for Partition Lost Events .....	199
Writing a Partition Lost Listener Class .....	199
Registering Partition Lost Listeners .....	200
8.1.5. Listening for Lifecycle Events .....	200
Registering Lifecycle Listeners .....	201
8.1.6. Listening for Clients .....	202
8.2. Distributed Object Events .....	203
8.2.1. Listening for Map Events .....	203
Catching a Map Event .....	203
8.2.2. Listening for Lost Map Partitions .....	205
Registering Map Listeners .....	206
Map Listener Attributes .....	207
8.2.3. Listening for MultiMap Events .....	207
Registering MultiMap Listeners .....	208
MultiMap Listener Attributes .....	209
8.2.4. Listening for Item Events .....	209
Registering Item Listeners .....	209
Item Listener Attributes .....	210
8.2.5. Listening for Topic Messages .....	210
Registering Message Listeners .....	211
8.3. Event Listeners for Hazelcast Clients .....	212
8.4. Global Event Configuration .....	212
9. Hazelcast Jet .....	213
9.1. Overview .....	213
9.1.1. How You Can Use It .....	213
9.1.2. Where You Can Use It .....	213
9.1.3. Data Processing Styles .....	214
9.2. Relationship with Hazelcast IMDG .....	214
9.3. Hazelcast IMDG Computing vs. Hazelcast Jet .....	215
10. Distributed Computing .....	216
10.1. Executor Service .....	216
10.1.1. Implementing a Callable Task .....	216
Executing a Callable Task .....	218
10.1.2. Implementing a Runnable Task .....	219
Executing a Runnable Task .....	219
10.1.3. Scaling The Executor Service .....	220



10.1.4. Executing Code in the Cluster .....	220
10.1.5. Canceling an Executing Task .....	222
Example Task to Cancel .....	222
Example Method to Execute and Cancel the Task .....	222
10.1.6. Callback When Task Completes .....	223
Example Task to Callback .....	223
Example Method to Callback the Task .....	224
10.1.7. Selecting Members for Task Execution .....	225
10.1.8. Configuring Executor Service .....	226
10.1.9. Split-Brain Protection for IExecutorService .....	226
10.2. Durable Executor Service .....	227
10.2.1. Configuring Durable Executor Service .....	228
10.2.2. Split-Brain Protection for Durable Executor Service .....	229
10.3. Scheduled Executor Service .....	229
10.3.1. Configuring Scheduled Executor Service .....	231
10.3.2. Examples .....	232
10.3.3. Split-Brain Protection for IScheduled Executor Service .....	232
10.4. Entry Processor .....	233
10.4.1. Performing Fast In-Memory Map Operations .....	234
Using Indexes .....	234
Using OBJECT In-Memory Format .....	234
Processing Entries .....	234
Respecting Locks on Single Keys .....	235
Processing Backup Entries .....	235
10.4.2. Creating an Entry Processor .....	235
10.4.3. Abstract Entry Processor .....	236
10.4.4. Entry Processor Performance Optimizations .....	237
Offloadable Entry Processor .....	237
ReadOnly Entry Processor .....	238
ReadOnly and Offloadable Entry Processor .....	239
11. Distributed Query .....	240
11.1. How Distributed Query Works .....	240
11.1.1. Employee Map Query Example .....	240
11.1.2. Querying with Criteria API .....	241
Predicates Class Operators .....	242
Combining Predicates with AND, OR, NOT .....	242
Simplifying with PredicateBuilder .....	243
11.1.3. Querying with SQL .....	243
Supported SQL Syntax .....	243
Querying Entry Keys with Predicates .....	244
11.1.4. Filtering with Paging Predicates .....	245

11.1.5. Filtering with Partition Predicate .....	246
11.1.6. Indexing Queries .....	246
Indexing Ranged Queries .....	247
Configuring IMap Indexes .....	247
Copying Indexes .....	248
Indexing Attributes with ValueExtractor .....	248
Using "this" as an Attribute .....	248
11.1.7. Configuring Query Thread Pool .....	249
Query Requests from Clients .....	249
11.2. Querying in Collections and Arrays .....	250
11.2.1. Indexing in Collections and Arrays .....	251
11.2.2. Corner cases .....	252
11.3. Custom Attributes .....	252
11.3.1. Implementing a ValueExtractor .....	253
ValueExtractor with Portable Serialization .....	253
Returning Multiple Values from a Single Extraction .....	253
11.3.2. Extraction Arguments .....	254
11.3.3. Configuring a Custom Attribute Programmatically .....	254
11.3.4. Configuring a Custom Attribute Declaratively .....	254
11.3.5. Indexing Custom Attributes .....	255
11.4. MapReduce .....	255
11.4.1. Understanding MapReduce .....	256
MapReduce Workflow Example .....	256
MapReduce Phases .....	257
Additional MapReduce Resources .....	258
11.4.2. Using the MapReduce API .....	259
Retrieving a JobTracker Instance .....	259
Creating a Job .....	260
Creating Key-Value Input Sources with KeyValueSource .....	261
Implementing Mapping Logic with Mapper .....	262
Minimizing Cluster Traffic with Combiner .....	263
Doing Algorithm Work with Reducer .....	264
Modifying the Result with Collator .....	265
Preselecting Keys with KeyPredicate .....	266
Job Monitoring with TrackableJob .....	266
Configuring JobTracker .....	267
11.4.3. Hazelcast MapReduce Architecture .....	268
Member Interoperation Example .....	268
Internal MapReduce Packages .....	270
MapReduce Job Walk-Through .....	270
11.4.4. MapReduce Deprecation .....	271

Motivation .....	271
Built-In Aggregations .....	271
Distributed Computation with Jet .....	272
Jet Compared with New Aggregations .....	277
11.5. Aggregators .....	277
11.5.1. Aggregations Basics .....	277
Aggregations and Map Interfaces .....	277
Aggregations and Java .....	278
Aggregations and Java 6 or Java 7 .....	278
Aggregations and Java 8 .....	278
Aggregations and the MapReduce Framework .....	279
11.5.2. Using the Aggregations API .....	279
Supplier .....	279
Defining the Aggregation Operation .....	282
Extracting Attribute Values with PropertyExtractor .....	283
Configuring Aggregations .....	284
11.5.3. Aggregations Examples .....	285
Setting up the Data Model .....	285
Average Aggregation Example .....	287
Map Join Example .....	287
Grouping Example .....	288
Simple Count Example .....	289
11.5.4. Implementing Aggregations .....	289
Aggregation Methods .....	290
11.6. Fast-Aggregations .....	290
11.6.1. Aggregator API .....	290
11.6.2. Fast-Aggregations and Map Interfaces .....	291
11.6.3. Sample Implementation .....	291
11.6.4. Built-In Aggregations .....	292
11.6.5. Configuration Options .....	293
11.7. Projections .....	293
11.7.1. Projection API .....	293
Projections and Map Interfaces .....	293
11.7.2. Sample implementation .....	294
11.7.3. Built-In Projections .....	294
11.8. Continuous Query Cache .....	295
11.8.1. Keeping Query Results Local and Ready .....	295
11.8.2. Accessing Continuous Query Cache from Member .....	295
11.8.3. Accessing Continuous Query Cache from Client Side .....	295
11.8.4. Features of Continuous Query Cache .....	296
11.8.5. Configuring Continuous Query Cache .....	296

12. Transactions .....	298
12.1. Creating a Transaction Interface .....	298
12.1.1. Queue/Set/List vs. Map/Multimap .....	300
12.1.2. ONE_PHASE vs. TWO_PHASE .....	300
12.2. Providing XA Transactions .....	300
13. Hazelcast JCache .....	301
13.1. JCache Overview .....	301
13.1.1. Supported JCache Versions .....	302
13.1.2. Upgrading from JCache 1.0.0 to 1.1.0 .....	302
13.2. JCache Setup and Configuration .....	302
13.2.1. Setting up Your Application .....	303
Activating Hazelcast as JCache Provider .....	303
Connecting Clients to Remote Member .....	304
13.2.2. Example JCache Application .....	304
Getting the Hazelcast JCache Implementation .....	305
Setting up the JCache Entry Point .....	305
Configuring the Cache Before Creating It .....	305
Creating the Cache .....	305
get, put and getAndPut .....	305
13.2.3. Configuring for JCache .....	305
JCache Declarative Configuration .....	305
JCache Programmatic Configuration .....	307
13.3. JCache Providers .....	308
13.3.1. Configuring JCache Provider .....	308
13.3.2. Configuring JCache with Client Provider .....	309
13.3.3. Configuring JCache with Server Provider .....	309
13.4. JCache API .....	310
13.4.1. JCache API Application Example .....	310
Creating User Class Example .....	310
Creating DAO Interface Example .....	310
Configuring JCache Example .....	311
13.4.2. JCache Base Classes .....	312
13.4.3. Implementing Factory and FactoryBuilder .....	313
13.4.4. Implementing CacheLoader .....	313
Cache read-through .....	314
CacheLoader Example .....	314
13.4.5. CacheWriter .....	315
13.4.6. Implementing EntryProcessor .....	317
13.4.7. CacheEntryListener .....	318
13.4.8. ExpiryPolicy .....	320
13.5. JCache - Hazelcast Instance Integration .....	321

13.5.1. JCache and Hazelcast Instance Awareness .....	322
13.6. Hazelcast JCache Extension - ICache .....	322
13.6.1. Scoping to Join Clusters .....	323
Examples .....	323
Applying Configuration Scope .....	325
Binding to a Named Instance .....	327
Binding to an Existing Hazelcast Instance Object .....	329
13.6.2. Namespacing .....	330
13.6.3. Retrieving an ICache Instance .....	330
13.6.4. ICache Configuration .....	331
13.6.5. ICache Async Methods .....	332
13.6.6. Defining a Custom ExpiryPolicy .....	334
13.6.7. JCache Eviction .....	335
Eviction and Runtime .....	335
Cache Types .....	335
Configuring Eviction Policies .....	336
Eviction Strategy .....	338
Eviction Algorithm .....	339
13.6.8. JCache Near Cache .....	342
13.6.9. ICache Convenience Methods .....	342
13.6.10. Implementing BackupAwareEntryProcessor .....	342
13.6.11. ICache Partition Lost Listener .....	344
13.7. Testing for JCache Specification Compliance .....	345
14. Integrated Clustering .....	346
14.1. Integration with Hibernate Second Level Cache .....	346
14.2. Web Session Replications .....	346
14.3. Integration with Java EE .....	346
14.4. Integration with Spring .....	347
14.4.1. Configuring Spring .....	347
Enabling Spring Integration .....	347
Troubleshooting .....	347
Declaring Beans by Spring <b>beans</b> Namespace .....	348
Declaring Beans by <b>hazelcast</b> Namespace .....	348
Supported Configurations with <b>hazelcast</b> Namespace .....	349
14.4.2. Enabling SpringAware Objects .....	352
SpringAware Examples .....	352
14.4.3. Adding Caching to Spring .....	355
Declarative Spring Cache Configuration .....	356
Defining Timeouts for Cache Read Operation .....	356
Declarative Hazelcast JCache Based Caching Configuration .....	357
Annotation-Based Spring Cache Configuration .....	357

14.4.4. Configuring Hibernate Second Level Cache .....	358
14.4.5. Configuring Hazelcast Transaction Manager .....	359
Sample Configuration for Hazelcast Transaction Manager .....	359
Sample Transactional Method .....	360
14.4.6. Best Practices .....	360
15. Storage .....	361
15.1. High-Density Memory Store .....	361
15.1.1. Configuring High-Density Memory Store .....	362
15.2. Sizing Practices .....	364
15.3. Hot Restart Persistence .....	364
15.3.1. Hot Restart Persistence Overview .....	364
15.3.2. Hot Restart Types .....	365
15.3.3. Restart Process .....	365
Restart of a Member in Running Cluster .....	366
15.3.4. Force Start .....	366
15.3.5. Partial Start .....	367
15.3.6. Configuring Hot Restart .....	368
Global Hot Restart Configuration .....	368
Per Data Structure Hot Restart Configuration .....	369
Hot Restart Configuration Examples .....	369
15.3.7. Moving/Copying Hot Restart Data .....	371
15.3.8. Hot Restart Persistence Design Details .....	371
15.3.9. Concurrent, Incremental, Generational GC .....	372
I/O Minimization Scheme .....	372
Cost-Benefit Factor .....	373
15.3.10. Hot Restart Performance Considerations .....	373
Performance on a Physical Server .....	373
Performance on AWS R3 .....	374
15.3.11. Hot Backup .....	375
Configuring Hot Backup .....	375
Using Hot Backup .....	376
Starting the Cluster From a Hot Backup .....	377
Achieving High Consistency of Backup Data .....	378
Achieving High Performance of Backup Process .....	378
Backup Process Progress and Completion .....	379
Backup Task Interruption and Cancellation .....	379
15.4. Hazelcast Striim Hot Cache .....	380
16. Hazelcast Clients .....	381
16.1. Java Client .....	381
16.1.1. Getting Started with Java Client .....	382
Client API .....	382

Java Client Operation Modes .....	383
Handling Failures .....	383
Using Supported Distributed Data Structures .....	385
Using Client Services .....	386
Client Listeners .....	388
Client Transactions .....	388
Async Start and Reconnect Modes .....	388
16.1.2. Configuring Java Client .....	389
Client Network .....	390
Configuring Client Load Balancer .....	399
Configuring Client Listeners .....	400
Configuring Client Connection Strategy .....	400
Configuring Client Connection Retry .....	401
Other Configurations .....	403
16.1.3. Java Client Failure Detectors .....	404
Client Deadline Failure Detector .....	405
Client Ping Failure Detector .....	405
16.1.4. Client System Properties .....	408
16.1.5. Using High-Density Memory Store with Java Client .....	411
16.2. C++ Client .....	413
16.3. .NET Client .....	413
16.4. REST Client .....	414
16.4.1. REST Client GET/POST/DELETE Examples .....	414
Creating/Updating Entries in a Map for REST Client .....	415
Retrieving Entries from a Map for REST Client .....	415
Removing Entries from a Map for REST Client .....	415
Offering Items on a Queue for REST Client .....	416
Retrieving Items from a Queue for REST Client .....	416
Getting the size of the queue for REST Client .....	417
16.4.2. Checking the Status of the Cluster for REST Client .....	417
16.5. Memcache Client .....	418
16.5.1. Memcache Client Code Examples .....	418
16.5.2. Unsupported Operations for Memcache .....	420
16.6. Python Client .....	420
16.7. Node.js Client .....	420
16.8. Go Client .....	420
16.9. Scala .....	420
17. Serialization .....	420
17.1. Serialization Interface Types .....	421
17.2. Comparing Serialization Interfaces .....	422
17.3. Implementing Java Serializable and Externalizable .....	423

17.3.1. Implementing Java Externalizable .....	424
17.4. Implementing DataSerializable .....	425
17.4.1. Reading and Writing and DataSerializable .....	425
17.4.2. IdentifiedDataSerializable .....	427
getID and getFactoryId Methods .....	427
Implementing IdentifiedDataSerializable .....	427
Registering EmployeeDataSerializableFactory .....	429
17.5. Implementing Portable Serialization .....	429
17.5.1. Portable Serialization Example Code .....	430
17.5.2. Registering the Portable Factory .....	432
17.5.3. Versioning for Portable Serialization .....	432
Example Portable Versioning Scenarios .....	433
17.5.4. Ordering Consistency for writePortable .....	434
17.5.5. Null Portable Serialization .....	435
17.5.6. DistributedObject Serialization .....	435
17.6. Custom Serialization .....	435
17.6.1. Implementing StreamSerializer .....	435
StreamSerializer Example Code 1 .....	436
StreamSerializer Example Code 2 .....	437
Configuring StreamSerializer .....	438
17.6.2. Implementing ByteArraySerializer .....	439
Configuring ByteArraySerializer .....	439
17.7. Global Serializer .....	440
17.7.1. Sample Global Serializer .....	440
17.8. Implementing HazelcastInstanceAware .....	441
17.9. Untrusted Deserialization Protection .....	442
17.10. Serialization Configuration Wrap-Up .....	444
18. Management .....	446
18.1. Getting Member Statistics .....	446
18.1.1. Map Statistics .....	446
18.1.2. Map Index Statistics .....	447
18.1.3. Near Cache Statistics .....	448
18.1.4. Multimap Statistics .....	448
18.1.5. Queue Statistics .....	449
18.1.6. Topic Statistics .....	450
18.1.7. Executor Statistics .....	450
18.2. JMX API per Member .....	451
18.3. Monitoring with JMX .....	458
18.3.1. MBean Naming for Hazelcast Data Structures .....	459
18.3.2. Connecting to JMX Agent .....	459
18.4. Cluster Utilities .....	460



18.4.1. Getting Member Events and Member Sets .....	460
18.4.2. Managing Cluster and Member States .....	461
Cluster States .....	461
Cluster Member States .....	463
18.4.3. Using the Script cluster.sh .....	463
Example Usages for cluster.sh .....	464
18.4.4. Using REST API for Cluster Management .....	466
18.4.5. Enabling Lite Members .....	468
Configuring Lite Members .....	468
Promoting Lite Members to Data Member .....	468
18.4.6. Defining Member Attributes .....	468
18.4.7. Safety Checking Cluster Members .....	470
Ensuring Safe State with PartitionService .....	470
18.5. Diagnostics .....	471
18.5.1. Enabling Diagnostics Logging .....	471
18.5.2. Diagnostics Log File .....	471
18.5.3. Diagnostics Plugins .....	472
BuildInfo .....	472
SystemProperties .....	472
ConfigProperties .....	473
Metrics .....	473
SlowOperations .....	473
Invocations .....	473
HazelcastInstance .....	473
SystemLog .....	474
StoreLatency .....	474
OperationHeartbeats .....	475
MemberHeartbeats .....	476
OperationThreadSamples .....	476
WanDiagnostics .....	477
18.6. Health Check and Monitoring .....	478
18.6.1. Health Check .....	478
18.6.2. Health Check Script .....	479
18.6.3. Health Monitor .....	479
18.6.4. Using Health Check on F5 BIG-IP LTM .....	480
Monitor Types .....	480
Configuration .....	481
18.7. Management Center .....	482
18.7.1. Toggle Scripting Support .....	482
18.8. Clustered JMX and REST via Management Center .....	482
19. Security .....	483

19.1. Enabling JAAS Security .....	483
19.2. Socket Interceptor .....	483
19.3. Security Interceptor .....	486
19.4. Encryption .....	486
19.5. TLS/SSL .....	488
19.5.1. TLS/SSL for Hazelcast Members .....	488
Other Property Configuration Options .....	490
19.5.2. TLS/SSL for Hazelcast Clients .....	491
19.5.3. Mutual Authentication .....	491
19.5.4. TLS/SSL Performance Improvements for Java .....	493
19.5.5. TLS/SSL Debugging .....	494
19.5.6. TLS/SSL for Hazelcast Management Center .....	494
19.6. Integrating OpenSSL / BoringSSL .....	494
19.6.1. Netty Libraries .....	494
19.6.2. Using BoringSSL .....	495
19.6.3. Using OpenSSL .....	495
19.6.4. Configuring Hazelcast for OpenSSL .....	496
19.6.5. Configuring Cipher Suites .....	497
19.6.6. Other Ways of Configuring Properties .....	498
19.7. Credentials .....	499
19.8. Validating Secrets Using Strength Policy .....	500
19.8.1. Using a Custom Secret Strength Policy .....	501
19.8.2. Enforcing the Secret Strength Policy .....	501
19.9. ClusterLoginModule .....	502
19.9.1. Enterprise Integration .....	504
19.10. Cluster Member Security .....	504
19.11. Native Client Security .....	506
19.11.1. Authentication .....	506
19.11.2. Authorization .....	507
19.11.3. Permissions .....	509
Handling Permissions When a New Member Joins .....	514
20. Performance .....	515
20.1. Data Affinity .....	515
20.1.1. PartitionAware .....	515
20.1.2. PartitioningStrategy .....	519
20.2. Running in EC2 .....	520
20.3. Back Pressure .....	521
20.3.1. Member Side .....	521
20.3.2. Client Side .....	522
20.4. Threading Model .....	522
20.4.1. I/O Threading .....	522

20.4.2. Event Threading .....	523
20.4.3. IExecutor Threading .....	524
20.4.4. Operation Threading .....	524
Partition-aware Operations .....	524
Non-Partition-aware Operations.....	525
Priority Operations .....	526
Operation-response and Invocation-future .....	526
Local Calls.....	526
20.5. SlowOperationDetector .....	526
20.5.1. Logging of Slow Operations .....	527
20.5.2. Purging of Slow Operation Logs .....	527
20.6. Near Cache.....	527
20.6.1. Hazelcast Data Structures with Near Cache Support.....	528
20.6.2. Configuring Near Cache .....	529
20.6.3. Near Cache Configuration Examples .....	532
Near Cache Example for IMap.....	532
Near Cache Example for JCache Clients .....	534
Example for Near Cache with High-Density Memory Store .....	535
20.6.4. Near Cache Eviction.....	536
20.6.5. Near Cache Expiration .....	536
20.6.6. Near Cache Invalidation .....	536
20.6.7. Near Cache Consistency .....	537
Eventual Consistency.....	537
Locally Initiated Changes .....	537
20.6.8. Near Cache Preloader .....	538
20.7. Caching Deserialized Values .....	538
21. Hazelcast Simulator .....	539
22. WAN .....	539
22.1. WAN Replication .....	539
22.1.1. Defining WAN Replication .....	540
Defining WAN Replication Using Static Endpoints .....	540
Defining WAN Replication Using Discovery SPI .....	543
22.1.2. WanBatchReplication Implementation.....	548
22.1.3. Configuring WAN Replication for IMap and ICache .....	549
22.1.4. Batch Size .....	551
22.1.5. Batch Maximum Delay .....	552
22.1.6. Response Timeout .....	553
22.1.7. Queue Capacity .....	554
22.1.8. Queue Full Behavior .....	555
22.1.9. Event Filtering API.....	555
22.1.10. Acknowledgment Types .....	556

22.1.11. Synchronizing WAN Target Cluster .....	557
22.1.12. WAN Replication Failure Detection and Recovery .....	558
WAN Target Endpoint List .....	558
WAN Failure Detection .....	558
WAN Endpoint Recovery .....	558
22.1.13. WAN Replication Additional Information .....	559
22.2. Delta WAN Synchronization .....	559
22.2.1. Requirements .....	560
22.2.2. Using Delta WAN Synchronization .....	560
22.2.3. Configuring Delta WAN Synchronization .....	561
22.2.4. The Process .....	562
22.2.5. Memory Consumption .....	563
22.2.6. Defining the Depth .....	563
22.2.7. REST API .....	564
22.2.8. Statistics .....	565
22.3. Hazelcast WAN Replication with Solace .....	565
22.3.1. Enabling Integration .....	565
22.3.2. Configuring Publisher .....	566
22.3.3. Configuring Consumer .....	567
22.3.4. Additional Information .....	567
23. OSGI .....	568
23.1. OSGI Support .....	568
23.2. API .....	568
23.3. Configuring Hazelcast OSGI Support .....	568
23.4. Design .....	569
23.5. Using Hazelcast OSGI Service .....	570
23.5.1. Getting Hazelcast OSGI Service Instances .....	570
23.5.2. Managing and Using Hazelcast instances .....	570
24. Extending Hazelcast .....	571
24.1. User Defined Services .....	571
24.1.1. Creating the Service Class .....	572
24.1.2. Enabling the Service Class .....	573
24.1.3. Adding Properties to the Service .....	574
24.1.4. Starting the Service .....	574
24.1.5. Placing a Remote Call via Proxy .....	574
Making Counter a Distributed Object .....	575
Implementing ManagedService and RemoteService .....	575
Implementing CounterProxy .....	576
Dealing with Exceptions .....	578
Implementing the PartitionAwareOperation Interface .....	578
Running the Code .....	579

24.1.6. Creating Containers .....	580
Integrating the Container in the CounterService .....	581
Connecting the IncOperation.run Method to the Container .....	583
Running the Sample Code .....	584
24.1.7. Partition Migration .....	586
Transferring migrationData .....	587
Letting Hazelcast Know CounterService Can Do Partition Migrations .....	588
Running the Sample Code .....	590
24.1.8. Creating Backups .....	592
Performing the Backup with IncBackupOperation .....	593
Running the Sample Code .....	594
24.2. OperationParker .....	595
24.3. Discovery SPI .....	596
24.3.1. Discovery SPI Interfaces and Classes .....	596
DiscoveryStrategy: Implement .....	596
AbstractDiscoveryStrategy: Abstract Class .....	596
DiscoveryStrategyFactory: Factory Contract .....	596
DiscoveryNode: Describe a Member .....	597
SimpleDiscoveryNode: Default DiscoveryNode .....	597
NodeFilter: Filter Members .....	597
DiscoveryService: Support In Integrator Systems .....	597
DiscoveryServiceProvider: Provide a DiscoveryService .....	597
DiscoveryServiceSettings: Configure DiscoveryService .....	597
DiscoveryMode: Member or Client .....	597
24.3.2. Discovery Strategy .....	598
Discovery Strategy Example .....	598
Configuring Site Domain .....	598
Creating Discovery .....	598
Implementing Discovery Strategy .....	599
Extending The AbstractDiscoveryStrategy .....	600
Overriding Discovery Configuration .....	602
Implementing Lookup .....	602
Mapping to `DiscoveryNode`s .....	603
Configuring DiscoveryStrategy .....	604
24.3.3. DiscoveryService (Framework integration) .....	605
24.4. Config Properties SPI .....	606
24.4.1. Config Properties SPI Classes .....	606
PropertyDefinition: Define a Single Property .....	606
SimplePropertyDefinition: Basic PropertyDefinition .....	606
PropertyTypeConverter: Set of TypeConverters .....	606
ValueValidator and ValidationException .....	606

24.4.2. Config Properties SPI Example .....	607
Defining a Config PropertyDefinition .....	607
Providing a value in XML .....	607
Retrieving a PropertyDefinition Value .....	607
25. Hazelcast Plugins .....	608
25.1. Cloud Discovery Plugins .....	608
25.1.1. Hazelcast jclouds® .....	608
25.1.2. Hazelcast AWS .....	608
25.1.3. Hazelcast GCP .....	608
25.1.4. Hazelcast Azure .....	609
25.1.5. Hazelcast Consul .....	609
25.1.6. Hazelcast etcd .....	609
25.1.7. Hazelcast Eureka .....	609
25.1.8. Hazelcast IMDG and Jet for PCF .....	610
25.1.9. Hazelcast OpenShift .....	610
25.1.10. Hazelcast Heroku .....	610
25.1.11. Hazelcast Kubernetes .....	610
25.1.12. Hazelcast Zookeeper .....	611
25.2. Integration Plugins .....	611
25.2.1. Spring Data Hazelcast .....	611
25.2.2. Spring Integration Extension for Hazelcast .....	611
25.2.3. Hazelcast JCA Resource Adapter .....	612
Integrating with MuleSoft .....	612
25.2.4. Hazelcast Grails .....	612
25.2.5. Hazelcast Hibernate 2LC .....	612
25.2.6. Hazelcast DynaCache .....	613
25.2.7. Hazelcast Connector for Kafka .....	613
25.2.8. Openfire .....	613
25.2.9. SubZero .....	613
25.3. Web Sessions Clustering Plugins .....	613
25.3.1. Filter Based Web Session Replication .....	614
25.3.2. Tomcat Based Web Session Replication .....	614
25.3.3. Jetty Based Web Session Replication .....	614
25.4. Big Data Plugins .....	614
26. Consistency and Replication Model .....	615
26.1. A Brief Overview of Consistency and Replication in Distributed Systems .....	615
26.2. Hazelcast's Replication Algorithm .....	615
26.2.1. Best-Effort Consistency .....	616
26.3. Invocation Lifecycle .....	617
26.4. Exactly-once, At-least-once or At-most-once Execution .....	618
26.5. IndeterminateOperationStateException .....	618

27. Network Partitioning .....	619
27.1. Split-Brain Syndrome .....	619
27.2. Dealing with Network Partitions .....	619
27.3. Split-Brain Protection .....	619
27.3.1. Time Window for Split-Brain Protection .....	620
27.3.2. Configuring Split-Brain Protection .....	621
Member Count Quorum .....	621
Probabilistic Quorum Function .....	622
Recently-Active Quorum Function .....	624
Quorum Configuration Reference .....	624
27.3.3. Configuring Quorum Listeners .....	625
27.3.4. Querying Quorum Results .....	626
27.4. Split-Brain Recovery .....	627
27.4.1. Merge Policies .....	628
27.4.2. Supported Data Structures .....	628
27.4.3. Configuring Merge Policies .....	629
Declarative Configuration .....	629
Programmatic Configuration .....	630
27.4.4. Custom Merge Policies .....	631
Merge Types .....	631
Accessing Deserialized Values .....	634
Accessing Hazelcast UserContext .....	638
Merge Policies With Multiple Merge Types .....	640
Merge Policies For Specific Data Structures .....	641
Best Practices .....	643
Appendix A: System Properties .....	644
Appendix B: Common Exception Types .....	655
Appendix C: License Questions .....	656
C.1. Embedded Dependencies .....	656
C.2. Runtime Dependencies .....	656
Appendix D: Frequently Asked Questions .....	657
Glossary .....	668











# Hazelcast IMDG Reference Manual

Version 3.11.2

## Preface

Welcome to the Hazelcast IMDG (In-Memory Data Grid) Reference Manual. This manual includes concepts, instructions and samples to guide you on how to use Hazelcast and build Hazelcast IMDG applications.

As the reader of this manual, you must be familiar with the Java programming language and you should have installed your preferred Integrated Development Environment (IDE).

## Hazelcast IMDG Editions

This Reference Manual covers all editions of Hazelcast IMDG. Throughout this manual:

- **Hazelcast** or **Hazelcast IMDG** refers to the open source edition of Hazelcast in-memory data grid middleware. **Hazelcast** is also the name of the company (Hazelcast, Inc.) providing the Hazelcast product.
- **Hazelcast IMDG Enterprise** is a commercially licensed edition of Hazelcast IMDG which provides high-value enterprise features in addition to Hazelcast IMDG.
- **Hazelcast IMDG Enterprise HD** is a commercially licensed edition of Hazelcast IMDG which provides High-Density (HD) Memory Store and Hot Restart Persistence features in addition to Hazelcast IMDG Enterprise.

## Hazelcast IMDG Architecture

You can see the features for all Hazelcast IMDG editions in the following architecture diagram.

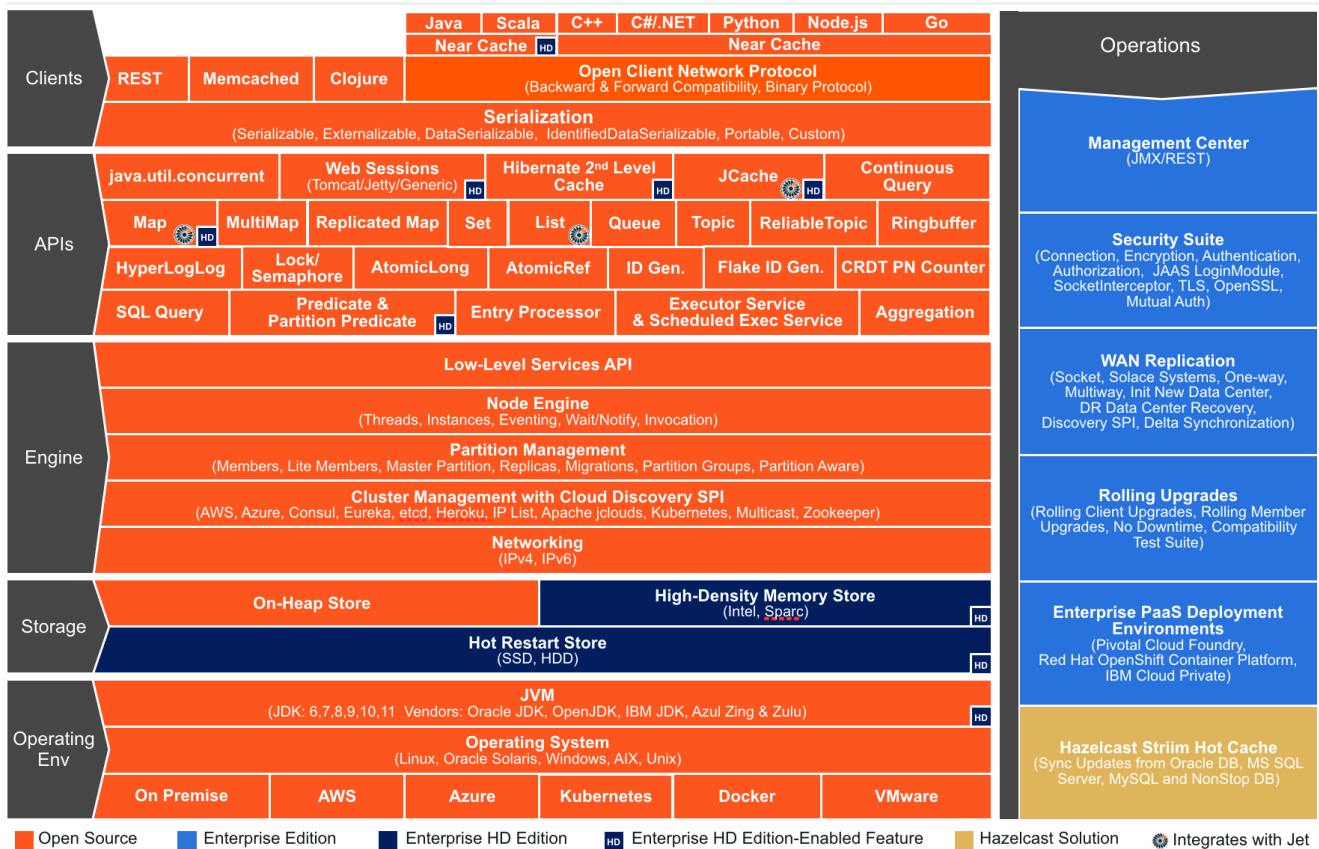

You can see small "HD" boxes for some features in the above diagram. Those features can use High-Density (HD) Memory Store when it is available. It means if you have Hazelcast IMDG Enterprise HD, you can use those features with HD Memory Store.

For more information on Hazelcast IMDG's Architecture, please see the white paper [An Architect's View of Hazelcast](#).

## Hazelcast IMDG Plugins

You can extend Hazelcast IMDG's functionality by using its plugins. These plugins have their own lifecycles. Please see [Plugins page](#) to learn about Hazelcast plugins you can use. Hazelcast plugins are marked with  label throughout this manual. See also the [Hazelcast Plugins chapter](#) for more information.

## Licensing

Hazelcast IMDG and Hazelcast Reference Manual are free and provided under the Apache License, Version 2.0. Hazelcast IMDG Enterprise and Hazelcast IMDG Enterprise HD is commercially licensed by Hazelcast, Inc.

For more detailed information on licensing, please see the [License Questions appendix](#).

# Trademarks

Hazelcast is a registered trademark of Hazelcast, Inc. All other trademarks in this manual are held by their respective owners.

# Customer Support

Support for Hazelcast is provided via [GitHub](#), [Mail Group](#) and [StackOverflow](#).

For information on the commercial support for Hazelcast IMDG and Hazelcast IMDG Enterprise, please see [hazelcast.com](http://hazelcast.com).

# Release Notes

Please refer to the [Release Notes document](#) for the new features, enhancements and fixes performed for each Hazelcast IMDG release.

# Contributing to Hazelcast IMDG

You can contribute to the Hazelcast IMDG code, report a bug, or request an enhancement. Please see the following resources.

- [Developing with Git](#): Document that explains the branch mechanism of Hazelcast and how to request changes.
- [Hazelcast Contributor Agreement form](#): Form that each contributing developer needs to fill and send back to Hazelcast.
- [Hazelcast on GitHub](#): Hazelcast repository where the code is developed, issues and pull requests are managed.

# Partners

Hazelcast partners with leading hardware and software technologies, system integrators, resellers and OEMs including Amazon Web Services, Vert.x, Azul Systems, C2B2. Please see the [Partners](#) page for the full list of and information on our partners.

# Phone Home

Hazelcast uses phone home data to learn about usage of Hazelcast IMDG.

Hazelcast IMDG member instances call our phone home server initially when they are started and then every 24 hours. This applies to all the instances joined to the cluster.

## What is sent in?

The following information is sent in a phone home:

- Hazelcast IMDG version

- Local Hazelcast IMDG member UUID
- Download ID
- A hash value of the cluster ID
- Cluster size bands for 5, 10, 20, 40, 60, 100, 150, 300, 600 and > 600
- Number of connected clients bands of 5, 10, 20, 40, 60, 100, 150, 300, 600 and > 600
- Cluster uptime
- Member uptime
- Environment Information:
  - Name of operating system
  - Kernel architecture (32-bit or 64-bit)
  - Version of operating system
  - Version of installed Java
  - Name of Java Virtual Machine
- Hazelcast IMDG Enterprise specific:
  - Number of clients by language (Java, C++, C#)
  - Flag for Hazelcast Enterprise
  - Hash value of license key
  - Native memory usage
- Hazelcast Management Center specific:
  - Hazelcast Management Center version
  - Hash value of Hazelcast Management Center license key

## Phone Home Code

The phone home code itself is open source. Please see [here](#).

## Disabling Phone Homes

Set the `hazelcast.phone.home.enabled` system property to false either in the config or on the Java command line. Please see the [System Properties section](#) for information on how to set a property.

You can also disable the phone home using the environment variable `HZ_PHONE_HOME_ENABLED`. Simply add the following line to your `.bash_profile`:

```
export HZ_PHONE_HOME_ENABLED=false
```

## Phone Home URLs

For versions 1.x and 2.x: <http://www.hazelcast.com/version.jsp>.

For versions 3.x up to 3.6: <http://versioncheck.hazelcast.com/version.jsp>.

For versions after 3.6: <http://phonehome.hazelcast.com/ping>.

# 1. Document Revision History

This chapter lists the changes made to this document from the previous release.



Please refer to the [Release Notes](#) for the new features, enhancements and fixes performed for each Hazelcast release.\*

Table 1. Revision History

Chapter	Section	Description
<a href="#">Distributed Data Structures</a>	<a href="#">Ringbuffer</a>	Added a filtering example for the <a href="#">Reading Batched Items</a> section.
<a href="#">Getting Started</a>		Added <a href="#">Running in Modular Java</a> as a new section.
		Added <a href="#">Supported Java Virtual Machines</a> as a new section to summarize the compatibility between Hazelcast IMDG and various JVMs.
		Added <a href="#">License Information</a> as a new section to explain how you can retrieve your Hazelcast IMDG license details.
<a href="#">Setting Up Clusters</a>	<a href="#">Partition Group Configuration</a>	Added a note to the ZONE_AWARE type content suggesting to have equal number of members in each Availability Zone.
<a href="#">Distributed Data Structures</a>	<a href="#">Reliable Topic</a>	Enhanced the content to clarify the relation between Reliable Topic and Ringbuffer data structures.
	<a href="#">Map</a>	Added content for the newly introduced <code>maxIdle</code> parameter for the put operation. See the <a href="#">Evicting Specific Entries</a> section.
<a href="#">Distributed Query</a>		Added <a href="#">Using "this" as an Attribute</a> as a new section to explain how you can use the keyword "this" in your queries.
<a href="#">Hazelcast JCache</a>	<a href="#">Defining a Custom ExpiryPolicy</a>	Updated the content to mention about the method <code>setExpiryPolicy</code> which associates certain keys with custom expiry policies.



	JCache API	Added content related to eager expiration.
Storage	Hot Backup	Added <a href="#">Starting the Cluster From a Hot Backup</a> as a new section to explain how you can start your cluster with data from a hot backup.
Hazelcast Clients	Java Client	Added <a href="#">Configuring Client Connection Retry</a> as a new section.
Serialization		Added <a href="#">Untrusted Deserialization Protection</a> as a new section.
Management		Added <a href="#">Map Index Statistics</a> as a new section describing how to access map index statistics.
	Diagnostics	Added content for the new <a href="#">OperationThreadSamples</a> plugin.
		Added <a href="#">Toggle Scripting Support</a> as a new section.
Security	TLS/SSL	Performed a full review and updated the content to include the new properties <code>keyStoreType</code> and <code>trustStoreType</code> .
		Added <a href="#">Using BoringSSL</a> as a new section.
		Added <a href="#">Handling Permissions When a New Member Joins</a> as a new section.
WAN		Added URL information to synchronize all the maps in source and target clusters.
		Added <a href="#">Delta WAN Synchronization</a> as a new section.
	<a href="#">Configuring Consumer and Event Filtering API</a>	Added content related to the new event type <code>LOADED</code> and configuration element <code>persist-wan-replicated-data</code> .
		Added description for the <code>publisher-id</code> configuration attribute.
		Added the REST URL for clearing the event queues. See the <a href="#">Queue Capacity</a> section.

<a href="#">Hazelcast Plugins</a>		Added as a new chapter to describe the plugins using which you can extend Hazelcast IMDG's functionalities.
<a href="#">Network Partitioning</a>		Enhanced the <a href="#">Merge Types section</a> by adding the descriptions of all merge types.
<a href="#">System Properties</a>		Added definitions for the following system properties: <ul style="list-style-type: none"> <li>• <code>hazelcast.socket.buffer.direct</code></li> <li>• <code>hazelcast.security.permissions.operation.on-join</code></li> </ul>

## 2. Getting Started

This chapter explains how to install Hazelcast and start a Hazelcast member and client. It describes the executable files in the download package and also provides the fundamentals for configuring Hazelcast and its deployment options.

### 2.1. Installation

The following sections explain the installation of Hazelcast IMDG and Hazelcast IMDG Enterprise. It also includes notes and changes to consider when upgrading Hazelcast.

#### 2.1.1. Installing Hazelcast IMDG

You can find Hazelcast in standard Maven repositories. If your project uses Maven, you do not need to add additional repositories to your `pom.xml` or add `hazelcast-<version>.jar` file into your classpath (Maven does that for you). Just add the following lines to your `pom.xml`:

```
<dependencies>
  <dependency>
    <groupId>com.hazelcast</groupId>
    <artifactId>hazelcast</artifactId>
    <version>Hazelcast IMDG Version To Be Installed</version>
  </dependency>
</dependencies>
```

As an alternative, you can download and install Hazelcast IMDG yourself. You only need to:

- Download the package `hazelcast-<version>.zip` or `hazelcast-<version>.tar.gz` from [hazelcast.org](http://hazelcast.org).
- Extract the downloaded `hazelcast-<version>.zip` or `hazelcast-<version>.tar.gz`.
- Add the file `hazelcast-<version>.jar` to your classpath.

## 2.1.2. Installing Hazelcast IMDG Enterprise

There are two Maven repositories defined for Hazelcast IMDG Enterprise:

```
<repository>
  <id>Hazelcast Private Snapshot Repository</id>
  <url>https://repository.hazelcast.com/snapshot/</url>
</repository>
<repository>
  <id>Hazelcast Private Release Repository</id>
  <url>https://repository.hazelcast.com/release/</url>
</repository>
```

Hazelcast IMDG Enterprise customers may also define dependencies, a sample of which is shown below.

```
<dependency>
  <groupId>com.hazelcast</groupId>
  <artifactId>hazelcast-enterprise</artifactId>
  <version>Hazelcast IMDG Enterprise Version To Be Installed</version>
</dependency>
<dependency>
  <groupId>com.hazelcast</groupId>
  <artifactId>hazelcast-enterprise-all</artifactId>
  <version>Hazelcast IMDG Enterprise Version To Be Installed</version>
</dependency>
```

## 2.1.3. Setting the License Key

Hazelcast IMDG Enterprise offers you two types of licenses: **Enterprise** and **Enterprise HD**. The supported features differ in your Hazelcast setup according to the license type you own.

- **Enterprise license:** In addition to the open source edition of Hazelcast, Enterprise features are the following:
  - Security
  - WAN Replication
  - Clustered REST
  - Clustered JMX
  - Striim Hot Cache
  - Rolling Upgrades
- **Enterprise HD license:** In addition to the Enterprise features, Enterprise HD features are the following:
  - High-Density Memory Store
  - Hot Restart Persistence

To use Hazelcast IMDG Enterprise, you need to set the provided license key using one of the configuration methods shown below.



Hazelcast IMDG Enterprise license keys are required only for members. You do not need to set a license key for your Java clients for which you want to use IMDG Enterprise features.

### Declarative Configuration:

Add the below line to any place you like in the file `hazelcast.xml`. This XML file offers you a declarative way to configure your Hazelcast. It is included in the Hazelcast download package. When you extract the downloaded package, you will see the file `hazelcast.xml` under the `/bin` directory.

```
<hazelcast>
  ...
  <license-key>Your Enterprise License Key</license-key>
  ...
</hazelcast>
```

### Programmatic Configuration:

Alternatively, you can set your license key programmatically as shown below.

```
Config config = new Config();
config.setLicenseKey( "Your Enterprise License Key" );
```

### Spring XML Configuration:

If you are using Spring with Hazelcast, then you can set the license key using the Spring XML schema, as shown below.

```
<hz:config>
  ...
  <hz:license-key>Your Enterprise License Key</hz:license-key>
  ...
</hz:config>
```

### JVM System Property:

As another option, you can set your license key using the below command (the "-D" command line option).

```
-Dhazelcast.enterprise.license.key=Your Enterprise License Key
```

## License Key Format

License keys have the following format:

```
<Name of the Hazelcast edition>#<Count of the Members>#<License key>
```

The strings before the `<License key>` is the human readable part. You can use your license key with or without this human readable part. So, both the following example license keys are valid:

```
HazelcastEnterpriseHD#2Nodes#1q2w3e4r5t
```

```
1q2w3e4r5t
```

### 2.1.4. License Information

License information is available through the following Hazelcast APIs.

#### JMX

The MBean `HazelcastInstance.LicenseInfo` holds all the relative license details and can be accessed through Hazelcast's JMX port (if enabled).

- `maxNodeCountAllowed`: Maximum members allowed to form a cluster under the current license.
- `expiryDate`: Expiration date of the current license.
- `typeCode`: Type code of the current license.
- `type`: Type of the current license.
- `ownerEmail`: Email of the current license's owner.
- `companyName`: Company name on the current license.

Following is the list of license `type`s and `typeCode`s:

```
MANAGEMENT_CENTER(1, "Management Center"),  
ENTERPRISE(0, "Enterprise"),  
ENTERPRISE_SECURITY_ONLY(2, "Enterprise only with security"),  
ENTERPRISE_HD(3, "Enterprise HD"),  
CUSTOM(4, "Custom");
```

#### REST

You can access the license details by issuing a `GET` request through the REST API (if enabled) on the `/license` resource, as shown below.

```
curl -v http://localhost:5701/hazelcast/rest/license
```

Its output is similar to the following:

```
Note: Unnecessary use of -X or --request, GET is already inferred.
* Trying 127.0.0.1...
* TCP_NODELAY set
* Connected to localhost (127.0.0.1) port 5701 (#0)
> GET /hazelcast/rest/license HTTP/1.1
> Host: localhost:5701
> User-Agent: curl/7.58.0
> Accept: */*
> Content-Type: text/plain
>
< HTTP/1.1 200 OK
< Content-Type: text/plain
< Content-Length: 187
<

licenseInfo{"expiryDate":1560380399161,"maxNodeCount":10,"type":-
1,"companyName":"ExampleCompany","ownerEmail":"info@example.com","keyHash":"m1/u6waTNQ
+T4EWxnDRykJpwBmaV9uj+skZzv0SzDhs="}
```

## Logs

Besides the above approaches (JMX and REST) to access the license details, Hazelcast also starts to log a license information banner into the log files when the license expiration is approaching.

During the last two months prior to the expiration, this license information banner is logged daily, as a reminder to renew your license to avoid any interruptions. Once the expiration is due to a month, the frequency of logging this banner becomes hourly (instead of daily). Lastly, when the expiration is due in a week, this banner will be printed every 30 minutes.



Similar alerts are also present on the Hazelcast Management Center.

The banner has the following format:

```

@@@@@@@@@@@@@@@@@@@@@@@@@@@@@@@@@@@@@@@@@@@@@@@@ WARNING @@@@@@@@@@@@@@@@@@@@@@@@@@@@@@@@@@@@@@@@@@@@@@
HAZELCAST LICENSE WILL EXPIRE IN 29 DAYS.
Your Hazelcast cluster will stop working after this time.

Your license holder is customer@example-company.com, you should have them contact
our license renewal department, urgently on info@hazelcast.com
or call us on +1 (650) 521-5453

Please quote license id CUSTOM_TEST_KEY

@@@@@@@@@@@@@@@@@@@@@@@@@@@@@@@@@@@@@@@@@@@@@@@@@@@@@@@@@@@@@@@@@@@@@@@@@@@@@@@@@@@@@@@@@@@@@@@@@@@@@@@@@@@@

```



Please pay attention to the license warnings to prevent any possible interruptions in the operation of your Hazelcast applications.

## 2.2. Supported Java Virtual Machines

Following table summarizes the version compatibility between Hazelcast IMDG and various vendors' Java Virtual Machines (JVMs).

Table 2. Supported JVMs

Hazelcast IMDG Version	JDK Version	Oracle JDK	IBM SDK, Java Technology Edition	Azul Zing JDK	Azul Zulu OpenJDK
Up to 4.0 <i>(JDK 6 support will be dropped with the release of Hazelcast IMDG 4.0)</i>	6	✓	✗	✓	✓
Up to current	7	✓	✓	✓	✓
Up to current	8	✓	✓	✓	✓
<ul style="list-style-type: none"> <li>• 3.11 and newer: Fully supported.</li> <li>• 3.10 and older: Partially supported.</li> </ul>	9	✓	✗ (JDK not available yet)	✗ (JDK not available yet)	✓
<ul style="list-style-type: none"> <li>• 3.11 and newer: Fully supported.</li> <li>• 3.10 and older: Partially supported.</li> </ul>	10	✓	✗ (JDK not available yet)	✗ (JDK not available yet)	✓

Hazelcast IMDG Version	JDK Version	Oracle JDK	IBM SDK, Java Technology Edition	Azul Zing JDK	Azul Zulu OpenJDK
<ul style="list-style-type: none"> <li>• 3.11 and newer: Fully supported.</li> <li>• 3.10 and older: Partially supported.</li> </ul>	11	✘  (JDK not available yet)	✘  (JDK not available yet)	✘  (JDK not available yet)	✓



Hazelcast IMDG 3.10 and older releases are not fully tested on JDK 9 and newer, so there may be some features that are not working properly.

See the following sections for the details of Hazelcast IMDG supporting JDK 9 and newer:



- [Running in Modular Java](#): Talks about the new module system present in Java 9 and newer and how you can run a Hazelcast application on it.
- [TLS/SSL for Hazelcast Members](#): Lists [TLSv1.3](#), which comes with Java 11, as a supported TLS version.

## 2.3. Running in Modular Java

Java [project Jigsaw](#) brought a new Module System into Java 9 and newer. Hazelcast supports running in the modular environment. If you want to run your application with Hazelcast libraries on the modulepath, use following module names:

- `com.hazelcast.core` for `hazelcast-<version>.jar` and `hazelcast-enterprise-<version>.jar`
- `com.hazelcast.client` for `hazelcast-client-<version>.jar` and `hazelcast-enterprise-client-<version>.jar`

Don't use `hazelcast-all-<version>.jar` or `hazelcast-enterprise-all-<version>.jar` on the modulepath as it could lead to problems in module dependencies for your application. You can still use them on the classpath.

The Java Module System comes with stricter visibility rules. It affects Hazelcast which uses internal Java API to reach the best performance results.

Hazelcast needs `java.se` module and access to the following Java packages for a proper work:

- `java.base/jdk.internal.ref`
- `java.base/java.nio` (*reflective access*)
- `java.base/sun.nio.ch` (*reflective access*)
- `java.base/java.lang` (*reflective access*)
- `jdk.management/com.sun.management.internal` (*reflective access*)
- `java.management/sun.management` (*reflective access*)



You can provide the access to the above mentioned packages by using `--add-exports` and `--add-opens` (for the reflective access) Java arguments.

### Example: Running a member on the classpath

```
java --add-modules java.se \  
  --add-exports java.base/jdk.internal.ref=ALL-UNNAMED \  
  --add-opens java.base/java.lang=ALL-UNNAMED \  
  --add-opens java.base/java.nio=ALL-UNNAMED \  
  --add-opens java.base/sun.nio.ch=ALL-UNNAMED \  
  --add-opens java.management/sun.management=ALL-UNNAMED \  
  --add-opens jdk.management/com.sun.management.internal=ALL-UNNAMED \  
  -jar hazelcast-<version>.jar
```

### Example: Running a member on the modulepath

```
java --add-modules java.se \  
  --add-exports java.base/jdk.internal.ref=com.hazelcast.core \  
  --add-opens java.base/java.lang=com.hazelcast.core \  
  --add-opens java.base/java.nio=com.hazelcast.core \  
  --add-opens java.base/sun.nio.ch=com.hazelcast.core \  
  --add-opens java.management/sun.management=com.hazelcast.core \  
  --add-opens jdk.management/com.sun.management.internal=com.hazelcast.core \  
  --module-path lib \  
  --module com.hazelcast.core/com.hazelcast.core.server.StartServer
```

*This example expects `hazelcast-<version>.jar` placed in the `lib` directory.*

## 2.4. Upgrading from 3.x

- **Upgrading from 3.6.x to 3.7.x when using JCache:** Hazelcast 3.7 introduced changes in JCache implementation which broke compatibility of 3.6.x clients to 3.7-3.7.2 cluster members and vice versa, so 3.7-3.7.2 clients are also incompatible with 3.6.x cluster members. This issue only affects Java clients which use JCache functionality.

Starting with Hazelcast 3.7.3, a compatibility option is provided which can be used to ensure backwards compatibility with 3.6.x clients.

In order to upgrade a 3.6.x cluster and clients to 3.7.3 (or later), you will need to use this compatibility option on either the member or the client side, depending on which one is upgraded first:

- first upgrade your cluster members to 3.7.3, adding property `hazelcast.compatibility.3.6.client=true` to your configuration; when started with this property, cluster members are compatible with 3.6.x and 3.7.3+ clients but not with 3.7-3.7.2 clients. Once your cluster is upgraded, you may upgrade your applications to use client version 3.7.3+.

- upgrade your clients from 3.6.x to 3.7.3, adding property `hazelcast.compatibility.3.6.server=true` to your Hazelcast client configuration. A 3.7.3 client started with this compatibility option is compatible with 3.6.x and 3.7.3+ cluster members but incompatible with 3.7-3.7.2 cluster members. Once your clients are upgraded, you may then proceed to upgrade your cluster members to version 3.7.3 or later.

You may use any of the supported ways as described in the [System Properties section](#) to configure the compatibility option. When done upgrading your cluster and clients, you may remove the compatibility property from your Hazelcast member configuration.

- **Upgrading from 3.6.x to 3.8.x EE when using JCache:** Due to a compatibility problem CacheConfig serialization may not work if your member is 3.8.x where  $x < 5$ . Hence, you will need to use the 3.8.5 or higher version where the problem is being fixed.
- **Introducing the `spring-aware` element:** Before the release 3.5, Hazelcast uses `SpringManagedContext` to scan `SpringAware` annotations by default. This may cause some performance overhead for the users who do not use `SpringAware`. This behavior has been changed with the release of Hazelcast 3.5. `SpringAware` annotations are disabled by default. By introducing the `spring-aware` element, now it is possible to enable it by adding the `<hz:spring-aware />` tag to the configuration. Please see the [Spring Integration section](#).
- **Introducing new configuration options for WAN replication:** Starting with Hazelcast 3.6, WAN replication related system properties, which are configured on a per member basis, can now be configured per target cluster. The 4 system properties below are no longer valid.
  - `hazelcast.enterprise.wanrep.batch.size`, please see the [WAN Replication Batch Size](#).
  - `hazelcast.enterprise.wanrep.batchfrequency.seconds`, please see the [WAN Replication Batch Maximum Delay](#).
  - `hazelcast.enterprise.wanrep.optimeout.millis`, please see the [WAN Replication Response Timeout](#).
  - `hazelcast.enterprise.wanrep.queue.capacity`, please see the [WAN Replication Queue Capacity](#).
- **Removal of deprecated `getId()` method:** The method `getId()` in the interface `DistributedObject` has been removed. Please use the method `getName()` instead.
- **Change in the Custom Serialization in the C++ Client Distribution:** Before, the method `getTypeId()` was used to retrieve the ID of the object to be serialized. Now, the method `getHazelcastTypeId()` is used and you give your object as a parameter to this new method. Also, `getTypeId()` was used in your custom serializer class, now it has been renamed to `getHazelcastTypeId()` too. Note that, these changes also apply when you want to switch from Hazelcast 3.6.1 to 3.6.2 too.
- **Important note about Hazelcast System Properties:** Even Hazelcast has not been recommending the usage of `GroupProperties.java` class while benefiting from System Properties, there has been a change to inform to the users who have been using this class. Starting with Hazelcast 3.7, the class `GroupProperties.java` has been replaced by `GroupProperty.java`. In this new class, system properties are instances of the newly introduced `HazelcastProperty` object. You can access the names of these properties by calling `getName()` method of `HazelcastProperty`.
- **Removal of `WanNoDelayReplication`:** `WanNoDelayReplication` implementation of Hazelcast's

WAN Replication has been removed starting with Hazelcast 3.7. You can still achieve this behavior by setting the batch size to `1` while configuring the `WanBatchReplication`. Please refer to the [Defining WAN Replication section](#) for more information.

- **Introducing `<wan-publisher>` element:** Starting with Hazelcast 3.8, the configuration element `<target-cluster>` is replaced with the element `<wan-publisher>` in WAN replication configuration.
- **WaitNotifyService interface has been renamed as `OperationParker`.**
- **Synchronizing WAN Target Cluster:** Starting with Hazelcast 3.8 release, the URL for the REST call has been changed from `http://member_ip:port/hazelcast/rest/wan/sync/map` to `http://member_ip:port/hazelcast/rest/mancenter/wan/sync/map`.

## 2.5. Upgrading from 2.x

- **Removal of deprecated static methods:** The static methods of Hazelcast class reaching Hazelcast data components have been removed. The functionality of these methods can be reached from the `HazelcastInstance` interface. You should replace the following:

```
Map<Integer, String> customers = Hazelcast.getMap( "customers" );
```

with

```
HazelcastInstance hazelcastInstance = Hazelcast.newHazelcastInstance();  
// or if you already started an instance named "instance1"  
// HazelcastInstance hazelcastInstance = Hazelcast.getHazelcastInstanceByName(  
"instance1" );  
Map<Integer, String> customers = hazelcastInstance.getMap( "customers" );
```

- **Renaming "instance" to "distributed object":** Before 3.0 there was confusion about the term "instance": it was used for both the cluster members and the distributed objects (map, queue, topic, etc. instances). Starting with Hazelcast 3.0, the term instance will be only used for Hazelcast instances, namely cluster members. We will use the term "distributed object" for map, queue, etc. instances. You should replace the related methods with the new renamed ones. 3.0 clients are smart clients in that they know in which cluster member the data is located, so you can replace your lite members with native clients.

```

public static void main( String[] args ) throws InterruptedException {
    HazelcastInstance hazelcastInstance = Hazelcast.newHazelcastInstance();
    IMap map = hazelcastInstance.getMap( "test" );
    Collection<Instance> instances = hazelcastInstance.getInstances();
    for ( Instance instance : instances ) {
        if ( instance.getInstanceType() == Instance.InstanceType.MAP ) {
            System.out.println( "There is a map with name: " + instance.getId() );
        }
    }
}

```

with

```

public static void main( String[] args ) throws InterruptedException {
    HazelcastInstance hazelcastInstance = Hazelcast.newHazelcastInstance();
    IMap map = hz.getMap( "test" );
    Collection<DistributedObject> objects = hazelcastInstance.getDistributedObjects(
);
    for ( DistributedObject distributedObject : objects ) {
        if ( distributedObject instanceof IMap ) {
            System.out.println( "There is a map with name: " + distributedObject.getName
() );
        }
    }
}

```

- **Package structure change:** PartitionService has been moved to package `com.hazelcast.core` from `com.hazelcast.partition`.
- **Listener API change:** Before 3.0, `removeListener` methods were taking the Listener object as a parameter. But this caused confusion because same listener object may be used as a parameter for different listener registrations. So we have changed the listener API. `addListener` methods returns a unique ID and you can remove a listener by using this ID. So you should do the following replacement if needed:

```

IMap map = hazelcastInstance.getMap( "map" );
map.addEntryListener( listener, true );
map.removeEntryListener( listener );

```

with

```

IMap map = hazelcastInstance.getMap( "map" );
String listenerId = map.addEntryListener( listener, true );
map.removeEntryListener( listenerId );

```

- **IMap changes:**

- `tryRemove(K key, long timeout, TimeUnit timeunit)` returns boolean indicating whether operation is successful.
- `tryLockAndGet(K key, long time, TimeUnit timeunit)` is removed.
- `putAndUnlock(K key, V value)` is removed.
- `lockMap(long time, TimeUnit timeunit)` and `unlockMap()` are removed.
- `getMapEntry(K key)` is renamed as `getEntryView(K key)`. The returned object's type, `MapEntry` class is renamed as `EntryView`.
- There is no predefined names for merge policies. You just give the full class name of the merge policy implementation:

```
<merge-policy>com.hazelcast.map.merge.PassThroughMergePolicy</merge-policy>
```

Also `MergePolicy` interface has been renamed to `MapMergePolicy` and also returning null from the implemented `merge()` method causes the existing entry to be removed.

- **IQueue changes:** There is no change on `IQueue` API but there are changes on how `IQueue` is configured. With Hazelcast 3.0 there will be no backing map configuration for queue. Settings like backup count will be directly configured on queue config. For queue configuration details, please see the [Queue section](#).
- **Transaction API change:** In Hazelcast 3.0, transaction API is completely different. Please see the [Transactions chapter](#).
- **ExecutorService API change:** Classes `MultiTask` and `DistributedTask` have been removed. All the functionality is supported by the newly presented interface `IExecutorService`. Please see the [Executor Service section](#).
- **LifeCycleService API:** The lifecycle has been simplified. `pause()`, `resume()`, `restart()` methods have been removed.
- **AtomicNumber:** `AtomicNumber` class has been renamed to `IAtomicLong`.
- **ICountDownLatch:** `await()` operation has been removed. We expect users to use `await()` method with timeout parameters.
- **ISemaphore API:** The `ISemaphore` has been substantially changed. `attach()`, `detach()` methods have been removed.
  - In 2.x releases, the default value for `max-size` eviction policy was `cluster_wide_map_size`. In 3.x releases, default is `PER_NODE`. After upgrading, the `max-size` should be set according to this new default, if it is not changed. Otherwise, it is likely that `OutOfMemory` exception may be thrown.

## 2.6. Starting the Member and Client

Having installed Hazelcast, you can get started.

In this short tutorial, you perform the following activities.

1. Create a simple Java application using the Hazelcast distributed map and queue.

2. Run our application twice to have a cluster with two members (JVMs).
3. Connect to our cluster from another Java application by using the Hazelcast Native Java Client API.

Let's begin.

- The following code starts the first Hazelcast member and creates and uses the `customers` map and queue.

```
Config cfg = new Config();
HazelcastInstance instance = Hazelcast.newHazelcastInstance(cfg);
Map<Integer, String> mapCustomers = instance.getMap("customers");
mapCustomers.put(1, "Joe");
mapCustomers.put(2, "Ali");
mapCustomers.put(3, "Avi");

System.out.println("Customer with key 1: " + mapCustomers.get(1));
System.out.println("Map Size: " + mapCustomers.size());

Queue<String> queueCustomers = instance.getQueue("customers");
queueCustomers.offer("Tom");
queueCustomers.offer("Mary");
queueCustomers.offer("Jane");
System.out.println("First customer: " + queueCustomers.poll());
System.out.println("Second customer: " + queueCustomers.peek());
System.out.println("Queue size: " + queueCustomers.size());
```

- Run this `GettingStarted` class a second time to get the second member started. The members form a cluster and the output is similar to the following.

```
Members {size:2, ver:2} [
  Member [127.0.0.1]:5701 - e40081de-056a-4ae5-8ffe-632caf8a6cf1 this
  Member [127.0.0.1]:5702 - 93e82109-16bf-4b16-9c87-f4a6d0873080
]
```

Here, you can see the size of your cluster (`size`) and member list version (`ver`). The member list version will be incremented when changes happen to the cluster, e.g., a member leaving from or joining to the cluster.

The above member list format is introduced with Hazelcast 3.9. You can enable the legacy member list format, which was used for the releases before Hazelcast 3.9, using the system property `hazelcast.legacy.memberlist.format.enabled`. Please see the [System Properties appendix](#). The following is an example for the legacy member list format:

```
Members [2] {
  Member [127.0.0.1]:5701 - c1ccc8d4-a549-4bff-bf46-9213e14a9fd2 this
  Member [127.0.0.1]:5702 - 33a82dbf-85d6-4780-b9cf-e47d42fb89d4
}
```

- Now, add the `hazelcast-client-<version>.jar` library to your classpath. This is required to use a Hazelcast client.
- The following code starts a Hazelcast Client, connects to our cluster, and prints the size of the `customers` map.

```
public class GettingStartedClient {

    public static void main( String[] args ) {
        ClientConfig clientConfig = new ClientConfig();
        HazelcastInstance client = HazelcastClient.newHazelcastClient( clientConfig
    );
        IMap map = client.getMap( "customers" );
        System.out.println( "Map Size:" + map.size() );
    }
}
```

- When you run it, you see the client properly connecting to the cluster and printing the map size as 3.

Hazelcast also offers a tool, **Management Center**, that enables you to monitor your cluster. You can download it from Hazelcast website's [download page](#). You can use it to monitor your maps, queues and other distributed data structures and members. Please see the [Hazelcast Management Center Reference Manual](#) for usage explanations.

By default, Hazelcast uses multicast to discover other members that can form a cluster. If you are working with other Hazelcast developers on the same network, you may find yourself joining their clusters under the default settings. Hazelcast provides a way to segregate clusters within the same network when using multicast. Please see the [Creating Cluster Groups](#) for more information. Alternatively, if you do not wish to use the default multicast mechanism, you can provide a fixed list of IP addresses that are allowed to join. Please see the [Join configuration section](#) for more information.



Multicast mechanism is not recommended for production since UDP is often blocked in production environments and other discovery mechanisms are more definite. Please see the [Discovery Mechanisms section](#).



You can also check the video tutorials [here](#).

## 2.7. Using the Scripts In The Package

When you download and extract the Hazelcast ZIP or TAR.GZ package, you will see the following scripts under the `/bin` folder that provide basic functionalities for member and cluster management.

The following are the names and descriptions of each script:

- `start.sh` / `start.bat`: Starts a Hazelcast member with default configuration in the working directory.
- `stop.sh` / `stop.bat`: Stops the Hazelcast member that was started in the current working directory.
- `cluster.sh`: Provides basic functionalities for cluster management, such as getting and changing the cluster state, shutting down the cluster or forcing the cluster to clean its persisted data and make a fresh start. Please refer to the [Using the Script `cluster.sh` section](#) to learn the usage of this script.



`start.sh` / `start.bat` scripts lets you start one Hazelcast instance per folder. To start a new instance, please unzip Hazelcast ZIP or TAR.GZ package in a new folder.



You can also use the start scripts to deploy your own library to a Hazelcast member. See the [Adding User Library to CLASSPATH section](#).

## 2.8. Deploying On Amazon EC2

You can deploy your Hazelcast project onto an Amazon EC2 environment using Third Party tools such as [Vagrant](#) and [Chef](#).

You can find a sample deployment project ([amazon-ec2-vagrant-chef](#)) with step-by-step instructions in the `hazelcast-integration` folder of the `hazelcast-code-samples` package, which you can download at [hazelcast.org](#). Please refer to this sample project for more information.

## 2.9. Deploying On Microsoft Azure

Plugin

You can deploy your Hazelcast cluster onto a Microsoft Azure environment. For this, your cluster should make use of Hazelcast Discovery Plugin for Microsoft Azure. You can find information about this plugin on its GitHub repository at [Hazelcast Azure](#).

For information on how to automatically deploy your cluster onto Azure, please see the [Deployment](#) section of [Hazelcast Azure](#) plugin repository.

## 2.10. Deploying On Pivotal Cloud Foundry

Plugin



Starting with Hazelcast 3.7, you can deploy your Hazelcast cluster onto Pivotal Cloud Foundry. It is available as a Pivotal Cloud Foundry Tile which you can download at [here](#). You can find the installation and usage instructions and the release notes documents at <https://docs.pivotal.io/partners/hazelcast/index.html>.

## 2.11. Deploying using Docker

Plugin

You can deploy your Hazelcast projects using the Docker containers. Hazelcast has the following images on Docker:

- Hazelcast IMDG
- Hazelcast IMDG Enterprise
- Hazelcast Management Center
- Hazelcast OpenShift

After you pull an image from the Docker registry, you can run your image to start the Management Center or a Hazelcast instance with Hazelcast's default configuration. All repositories provide the latest stable releases but you can pull a specific release too. You can also specify environment variables when running the image.

If you want to start a customized Hazelcast instance, you can extend the Hazelcast image by providing your own configuration file.

This feature is provided as a Hazelcast plugin. Please see its own GitHub repo at [Hazelcast Docker](#) for details on configurations and usages.

## 3. Hazelcast Overview

Hazelcast is an open source In-Memory Data Grid (IMDG). It provides elastically scalable distributed In-Memory computing, widely recognized as the fastest and most scalable approach to application performance. Hazelcast does this in open source. More importantly, Hazelcast makes distributed computing simple by offering distributed implementations of many developer-friendly interfaces from Java such as Map, Queue, ExecutorService, Lock and JCache. For example, the Map interface provides an In-Memory Key Value store which confers many of the advantages of NoSQL in terms of developer friendliness and developer productivity.

In addition to distributing data In-Memory, Hazelcast provides a convenient set of APIs to access the CPUs in your cluster for maximum processing speed. Hazelcast is designed to be lightweight and easy to use. Since Hazelcast is delivered as a compact library (JAR) and since it has no external dependencies other than Java, it easily plugs into your software solution and provides distributed data structures and distributed computing utilities.

Hazelcast is highly scalable and available. Distributed applications can use Hazelcast for distributed caching, synchronization, clustering, processing, pub/sub messaging, etc. Hazelcast is implemented in Java and has clients for Java, C/C++, .NET, REST, Python, Go and Node.js. Hazelcast also speaks

Memcached protocol. It plugs into Hibernate and can easily be used with any existing database system.

If you are looking for in-memory speed, elastic scalability and the developer friendliness of NoSQL, Hazelcast is a great choice.

### **Hazelcast is Simple**

Hazelcast is written in Java with no other dependencies. It exposes the same API from the familiar Java util package, exposing the same interfaces. Just add `hazelcast.jar` to your classpath and you can quickly enjoy JVMs clustering and start building scalable applications.

### **Hazelcast is Peer-to-Peer**

Unlike many NoSQL solutions, Hazelcast is peer-to-peer. There is no master and slave; there is no single point of failure. All members store equal amounts of data and do equal amounts of processing. You can embed Hazelcast in your existing application or use it in client and server mode where your application is a client to Hazelcast members.

### **Hazelcast is Scalable**

Hazelcast is designed to scale up to hundreds and thousands of members. Simply add new members and they will automatically discover the cluster and will linearly increase both memory and processing capacity. The members maintain a TCP connection between each other and all communication is performed through this layer.

### **Hazelcast is Fast**

Hazelcast stores everything in-memory. It is designed to perform very fast reads and updates.

### **Hazelcast is Redundant**

Hazelcast keeps the backup of each data entry on multiple members. On a member failure, the data is restored from the backup and the cluster will continue to operate without downtime.

## **3.1. Sharding in Hazelcast**

Hazelcast shards are called Partitions. By default, Hazelcast has 271 partitions. Given a key, we serialize, hash and mod it with the number of partitions to find the partition which the key belongs to. The partitions themselves are distributed equally among the members of the cluster. Hazelcast also creates the backups of partitions and distributes them among members for redundancy.



Please refer to the [Data Partitioning section](#) for more information on how Hazelcast partitions your data.

## **3.2. Hazelcast Topology**

You can deploy a Hazelcast cluster in two ways: Embedded or Client/Server.

If you have an application whose main focal point is asynchronous or high performance computing

and lots of task executions, then Embedded deployment is the preferred way. In Embedded deployment, members include both the application and Hazelcast data and services. The advantage of the Embedded deployment is having a low-latency data access.

See the below illustration.

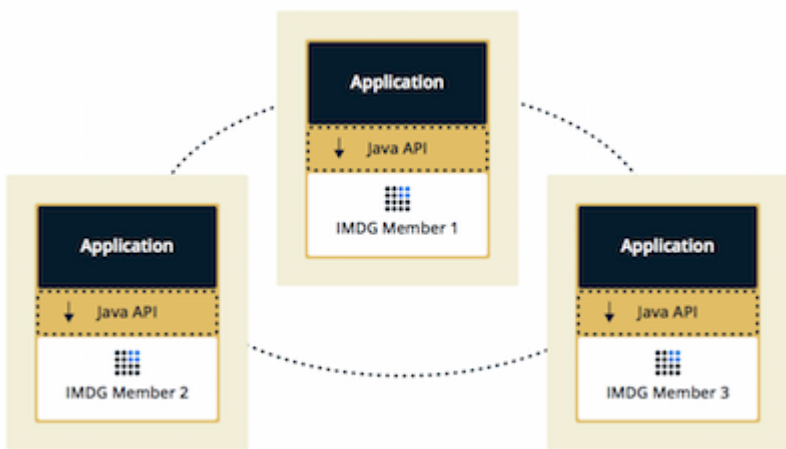

In the Client/Server deployment, Hazelcast data and services are centralized in one or more server members and they are accessed by the application through clients. You can have a cluster of server members that can be independently created and scaled. Your clients communicate with these members to reach to Hazelcast data and services on them.

See the below illustration.

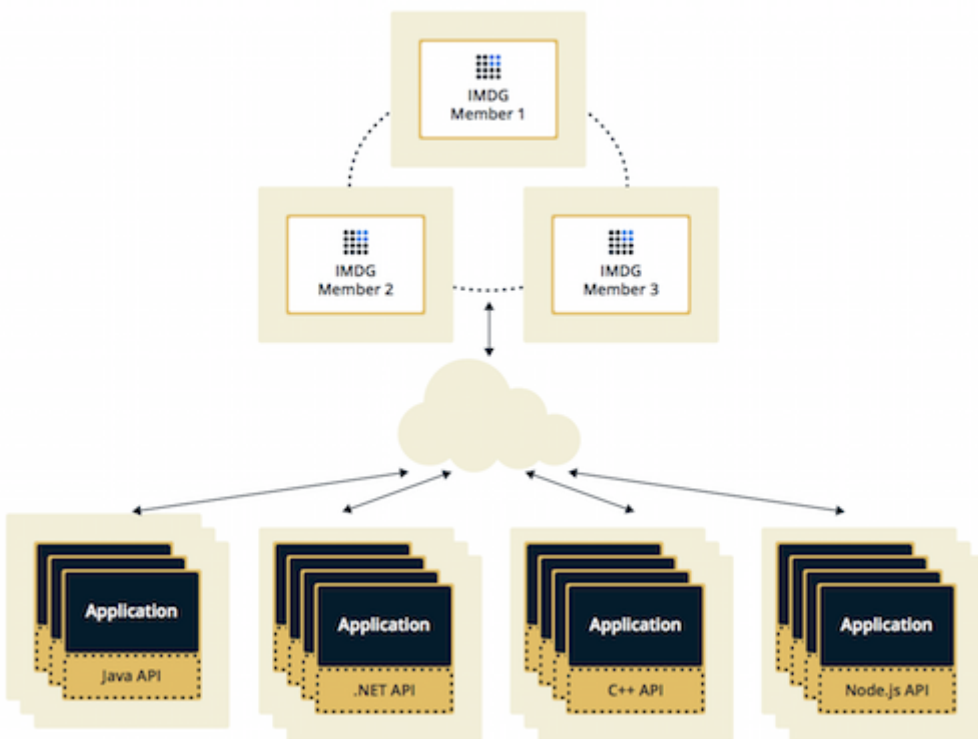

Hazelcast provides native clients (Java, .NET and C++), Memcache and REST clients, Scala, Python and Node.js client implementations.

Client/Server deployment has advantages including more predictable and reliable Hazelcast performance, easier identification of problem causes and, most importantly, better scalability.

When you need to scale in this deployment type, just add more Hazelcast server members. You can address client and server scalability concerns separately.

Note that Hazelcast **member** libraries are available only in Java. Therefore, embedding a member to a business service, it is only possible with Java. Applications written in other languages (.NET, C++, Node.js, etc.) can use Hazelcast client libraries to access the cluster. See the [Hazelcast Clients chapter](#) for information on the clients and other language implementations.

If you want low-latency data access, as in the Embedded deployment, and you also want the scalability advantages of the Client/Server deployment, you can consider defining Near Caches for your clients. This enables the frequently used data to be kept in the client's local memory. Please refer to the [Configuring Client Near Cache section](#).

## 3.3. Why Hazelcast?

### A Glance at Traditional Data Persistence

Data is at the core of software systems. In conventional architectures, a relational database persists and provides access to data. Applications are talking directly with a database which has its backup as another machine. To increase performance, tuning or a faster machine is required. This can cost a large amount of money or effort.

There is also the idea of keeping copies of data next to the database, which is performed using technologies like external key-value stores or second level caching that help offload the database. However, when the database is saturated or the applications perform mostly "put" operations (writes), this approach is of no use because it insulates the database only from the "get" loads (reads). Even if the applications are read-intensive there can be consistency problems - when data changes, what happens to the cache and how are the changes handled? This is when concepts like time-to-live (TTL) or write-through come in.

In the case of TTL, if the access is less frequent than the TTL, the result will always be a cache miss. On the other hand, in the case of write-through caches, if there are more than one of these caches in a cluster, we again will have consistency issues. This can be avoided by having the members communicate with each other so that entry invalidations can be propagated.

We can conclude that an ideal cache would combine TTL and write-through features. There are several cache servers and in-memory database solutions in this field. However, these are stand-alone single instances with a distribution mechanism that is provided by other technologies to an extent. So, we are back to square one; we experience saturation or capacity issues if the product is a single instance or if consistency is not provided by the distribution.

### And, there is Hazelcast

Hazelcast, a brand new approach to data, is designed around the concept of distribution. Hazelcast shares data around the cluster for flexibility and performance. It is an in-memory data grid for clustering and highly scalable data distribution.

One of the main features of Hazelcast is that it does not have a master member. Each cluster member is configured to be the same in terms of functionality. The oldest member (the first

member created in the cluster) automatically performs the data assignment to cluster members. If the oldest member dies, the second oldest member takes over.



You can come across with the term "master" or "master member" in some sections of this manual. They are used for contextual clarification purposes; please remember that they refer to the "oldest member" which is explained in the above paragraph.

Another main feature of Hazelcast is that the data is held entirely in-memory. This is fast. In the case of a failure, such as a member crash, no data will be lost since Hazelcast distributes copies of the data across all the cluster members.

As shown in the feature list in the [Distributed Data Structures chapter](#), Hazelcast supports a number of distributed data structures and distributed computing utilities. These provide powerful ways of accessing distributed clustered memory and accessing CPUs for true distributed computing.

### **Hazelcast's Distinctive Strengths**

- Hazelcast is open source.
- Hazelcast is only a JAR file. You do not need to install software.
- Hazelcast is a library, it does not impose an architecture on Hazelcast users.
- Hazelcast provides out-of-the-box distributed data structures, such as Map, Queue, MultiMap, Topic, Lock and Executor.
- There is no "master," meaning no single point of failure in a Hazelcast cluster; each member in the cluster is configured to be functionally the same.
- When the size of your memory and compute requirements increase, new members can be dynamically joined to the Hazelcast cluster to scale elastically.
- Data is resilient to member failure. Data backups are distributed across the cluster. This is a big benefit when a member in the cluster crashes as data will not be lost.
- Members are always aware of each other unlike in traditional key-value caching solutions.
- You can build your own custom-distributed data structures using the Service Programming Interface (SPI) if you are not happy with the data structures provided.

Finally, Hazelcast has a vibrant open source community enabling it to be continuously developed.

Hazelcast is a fit when you need:

- analytic applications requiring big data processing by partitioning the data.
- to retain frequently accessed data in the grid.
- a cache, particularly an open source JCache provider with elastic distributed scalability.
- a primary data store for applications with utmost performance, scalability and low-latency requirements.
- an In-Memory NoSQL Key Value Store.
- publish/subscribe communication at highest speed and scalability between applications.

- applications that need to scale elastically in distributed and cloud environments.
- a highly available distributed cache for applications.
- an alternative to Coherence and Terracotta.

## 3.4. Data Partitioning

As you read in the [Sharding in Hazelcast section](#), Hazelcast shards are called Partitions. Partitions are memory segments that can contain hundreds or thousands of data entries each, depending on the memory capacity of your system. Each Hazelcast partition can have multiple replicas, which are distributed among the cluster members. One of the replicas becomes the **primary** and other replicas are called **backups**. Cluster member which owns **primary** replica of a partition is called **partition owner**. When you read or write a particular data entry, you transparently talk to the owner of the partition that contains the data entry.

By default, Hazelcast offers 271 partitions. When you start a cluster with a single member, it owns all of 271 partitions (i.e., it keeps primary replicas for 271 partitions). The following illustration shows the partitions in a Hazelcast cluster with single member.

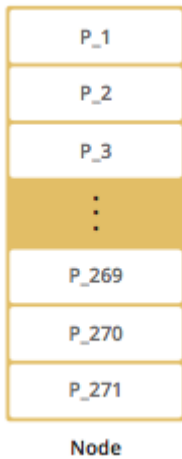

When you start a second member on that cluster (creating a Hazelcast cluster with two members), the partition replicas are distributed as shown in the illustration here.



Partition distributions in the below illustrations are shown for the sake of simplicity and for descriptive purposes. Normally, the partitions are not distributed in any order, as they are shown in these illustrations, but are distributed randomly (they do not have to be sequentially distributed to each member). The important point here is that Hazelcast equally distributes the partition primaries and their backup replicas among the members.

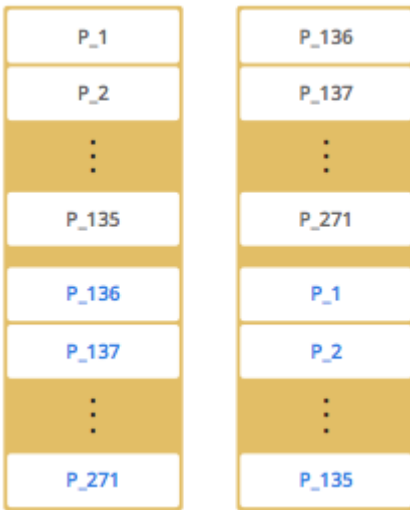

In the illustration, the partition replicas with black text are primaries and the partition replicas with blue text are backups. The first member has primary replicas of 135 partitions (black) and each of these partitions are backed up in the second member (i.e., the second member owns the backup replicas) (blue). At the same time, the first member also has the backup replicas of the second member's primary partition replicas.

As you add more members, Hazelcast moves some of the primary and backup partition replicas to the new members one by one, making all members equal and redundant. Thanks to the consistent hashing algorithm, only the minimum amount of partitions will be moved to scale out Hazelcast. The following is an illustration of the partition replica distributions in a Hazelcast cluster with four members.

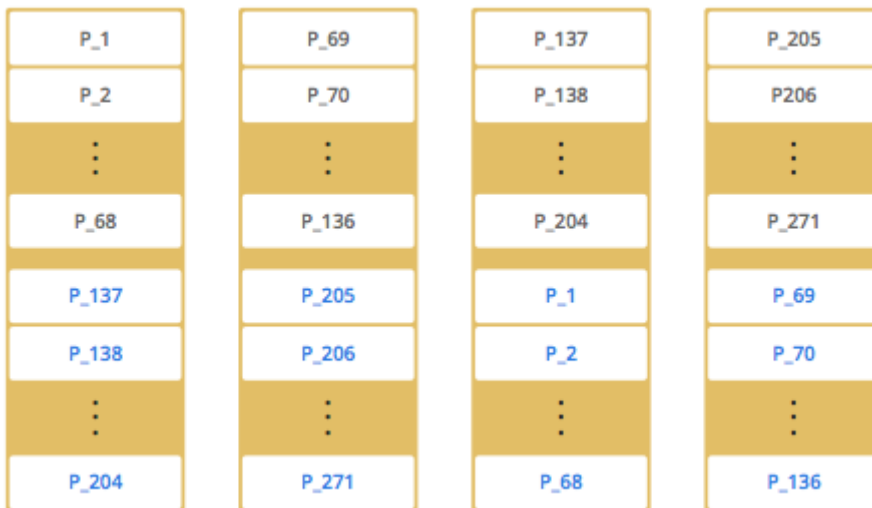

Hazelcast distributes partitions' primary and backup replicas equally among the members of the cluster. Backup replicas of the partitions are maintained for redundancy.



Your data can have multiple copies on partition primaries and backups, depending on your backup count. Please see the [Backing Up Maps section](#).

Starting with Hazelcast 3.6, lite members are introduced. Lite members are a new type of members that do not own any partition. Lite members are intended for use in computationally-heavy task executions and listener registrations. Although they do not own any partitions, they can access partitions that are owned by other members in the cluster.



Please refer to the [Enabling Lite Members section](#).

### 3.4.1. How the Data is Partitioned

Hazelcast distributes data entries into the partitions using a hashing algorithm. Given an object key (for example, for a map) or an object name (for example, for a topic or list):

- the key or name is serialized (converted into a byte array)
- this byte array is hashed
- the result of the hash is mod by the number of partitions

The result of this modulo - **MOD(hash result, partition count)** - is the partition in which the data will be stored, that is the **partition ID**. For ALL members you have in your cluster, the partition ID for a given key will always be the same.

### 3.4.2. Partition Table

When you start a member, a partition table is created within it. This table stores the partition IDs and the cluster members to which they belong. The purpose of this table is to make all members (including lite members) in the cluster aware of this information, making sure that each member knows where the data is.

The oldest member in the cluster (the one that started first) periodically sends the partition table to all members. In this way each member in the cluster is informed about any changes to partition ownership. The ownerships may be changed when, for example, a new member joins the cluster, or when a member leaves the cluster.



If the oldest member of the cluster goes down, the next oldest member sends the partition table information to the other ones.

You can configure the frequency (how often) that the member sends the partition table the information by using the `hazelcast.partition.table.send.interval` system property. The property is set to every 15 seconds by default.

### 3.4.3. Repartitioning

Repartitioning is the process of redistribution of partition ownerships. Hazelcast performs the repartitioning in the following cases:

- When a member joins to the cluster.
- When a member leaves the cluster.

In these cases, the partition table in the oldest member is updated with the new partition ownerships. Note that if a lite member joins or leaves a cluster, repartitioning is not triggered since lite members do not own any partitions.



## 3.5. Use Cases

Hazelcast can be used:

- to share server configuration/information to see how a cluster performs.
- to cluster highly changing data with event notifications, e.g., user based events, and to queue and distribute background tasks.
- as a simple Memcache with Near Cache.
- as a cloud-wide scheduler of certain processes that need to be performed on some members.
- to share information (user information, queues, maps, etc.) on the fly with multiple members in different installations under OSGI environments.
- to share thousands of keys in a cluster where there is a web service interface on an application server and some validation.
- as a distributed topic (publish/subscribe server) to build scalable chat servers for smartphones.
- as a front layer for a Cassandra back-end.
- to distribute user object states across the cluster, to pass messages between objects and to share system data structures (static initialization state, mirrored objects, object identity generators).
- as a multi-tenancy cache where each tenant has its own map.
- to share datasets, e.g., table-like data structure, to be used by applications.
- to distribute the load and collect status from Amazon EC2 servers where the front-end is developed using, for example, Spring framework.
- as a real-time streamer for performance detection.
- as storage for session data in web applications (enables horizontal scalability of the web application).

## 3.6. Resources

- Hazelcast source code can be found at [Github/Hazelcast](#).
- Hazelcast API can be found at [Hazelcast.org/docs/Javadoc](#).
- Code samples can be downloaded from [Hazelcast.org/download](#).
- More use cases and resources can be found at [Hazelcast.com](#).
- Questions and discussions can be posted at the [Hazelcast mail group](#).

# 4. Understanding Configuration

This chapter describes the options to configure your Hazelcast applications and explains the utilities which you can make use of while configuring. You can configure Hazelcast using one or mix of the following options:

- Declarative way

- Programmatic way
- Using Hazelcast system properties
- Within the Spring context
- Dynamically adding configuration on a running cluster

## 4.1. Configuring Declaratively

This is the configuration option where you use an XML configuration file. When you download and unzip `hazelcast-<version>.zip`, you will see the following files present in `/bin` folder, which are standard XML-formatted configuration files:

- `hazelcast.xml`: Default declarative configuration file for Hazelcast. The configuration in this XML file should be fine for most of the Hazelcast users. If not, you can tailor this XML file according to your needs by adding/removing/modifying properties.
- `hazelcast-full-example.xml`: Configuration file which includes all Hazelcast configuration elements and attributes with their descriptions. It is the "superset" of `hazelcast.xml`. You can use `hazelcast-full-example.xml` as a reference document to learn about any element or attribute, or you can change its name to `hazelcast.xml` and start to use it as your Hazelcast configuration file.

A part of `hazelcast.xml` is shown as an example below.

```

<group>
  <name>dev</name>
</group>
<management-center enabled="false">http://localhost:8080/mancenter</management-center>
<network>
  <port auto-increment="true" port-count="100">5701</port>
  <outbound-ports>
    <!--
    Allowed port range when connecting to other members.
    0 or * means the port provided by the system.
    -->
    <ports>0</ports>
  </outbound-ports>
  <join>
    <multicast enabled="true">
      <multicast-group>224.2.2.3</multicast-group>
      <multicast-port>54327</multicast-port>
    </multicast>
    <tcp-ip enabled="false">
      <interface>127.0.0.1</interface>
      <member-list>
        <member>127.0.0.1</member>
      </member-list>
    </tcp-ip>
  </join>
</network>
<map name="default">
  <time-to-live-seconds>0</time-to-live-seconds>
</map>

```

### 4.1.1. Composing Declarative Configuration

You can compose the declarative configuration of your Hazelcast member or Hazelcast client from multiple declarative configuration snippets. In order to compose a declarative configuration, you can use the `<import/>` element to load different declarative configuration files.

Let's say you want to compose the declarative configuration for Hazelcast out of two configurations: `development-group-config.xml` and `development-network-config.xml`. These two configurations are shown below.

`development-group-config.xml`:

```

<hazelcast>
  <group>
    <name>dev</name>
  </group>
</hazelcast>

```

development-network-config.xml:

```
<hazelcast>
  <network>
    <port auto-increment="true" port-count="100">5701</port>
    <join>
      <multicast enabled="true">
        <multicast-group>224.2.2.3</multicast-group>
        <multicast-port>54327</multicast-port>
      </multicast>
    </join>
  </network>
</hazelcast>
```

To get your example Hazelcast declarative configuration out of the above two, use the `<import/>` element as shown below.

```
<hazelcast>
  <import resource="development-group-config.xml"/>
  <import resource="development-network-config.xml"/>
</hazelcast>
```

This feature also applies to the declarative configuration of Hazelcast client. Please see the following examples.

client-group-config.xml:

```
<hazelcast-client>
  <group>
    <name>dev</name>
  </group>
</hazelcast-client>
```

client-network-config.xml:

```
<hazelcast-client>
  <network>
    <cluster-members>
      <address>127.0.0.1:7000</address>
    </cluster-members>
  </network>
</hazelcast-client>
```

To get a Hazelcast client declarative configuration from the above two examples, use the `<import/>` element as shown below.

```
<hazelcast-client>
  <import resource="client-group-config.xml"/>
  <import resource="client-network-config.xml"/>
</hazelcast>
```



Use `<import/>` element on top level of the XML hierarchy.

Using the element `<import>`, you can also load XML resources from classpath and file system:

```
<hazelcast>
  <import resource="file:///etc/hazelcast/development-group-config.xml"/> <!-- loaded
from filesystem -->
  <import resource="classpath:development-network-config.xml"/> <!-- loaded from
classpath -->
</hazelcast>
```

The element `<import>` supports variables too. Please see the following example snippet:

```
<hazelcast>
  <import resource="${environment}-group-config.xml"/>
  <import resource="${environment}-network-config.xml"/>
</hazelcast>
```



You can refer to the [Using Variables section](#) to learn how you can set the configuration elements with variables.

## 4.2. Configuring Programmatically

Besides declarative configuration, you can configure your cluster programmatically. For this you can create a `Config` object, set/change its properties and attributes and use this `Config` object to create a new Hazelcast member. Following is an example code which configures some network and Hazelcast Map properties.

```
Config config = new Config();
config.getNetworkConfig().setPort( 5900 )
    .setPortAutoIncrement( false );

MapConfig mapConfig = new MapConfig();
mapConfig.setName( "testMap" )
    .setBackupCount( 2 )
    .setTimeToLiveSeconds( 300 );
```

To create a Hazelcast member with the above example configuration, pass the configuration object as shown below:

```
HazelcastInstance hazelcast = Hazelcast.newHazelcastInstance( config );
```



The `Config` must not be modified after the Hazelcast instance is started. In other words, all configuration must be completed before creating the `HazelcastInstance`. Certain additional configuration elements can be added at runtime as described in the [Dynamically Adding Data Structure Configuration on a Cluster](#) section.

You can also create a named Hazelcast member. In this case, you should set `instanceName` of `Config` object as shown below:

```
Config config = new Config();  
config.setInstanceName( "my-instance" );  
Hazelcast.newHazelcastInstance( config );
```

To retrieve an existing Hazelcast member by its name, use the following:

```
Hazelcast.getHazelcastInstanceByName( "my-instance" );
```

To retrieve all existing Hazelcast members, use the following:

```
Hazelcast.getAllHazelcastInstances();
```



Hazelcast performs schema validation through the file `hazelcast-config-  
<version>.xsd` which comes with your Hazelcast libraries. Hazelcast throws a meaningful exception if there is an error in the declarative or programmatic configuration.

If you want to specify your own configuration file to create `Config`, Hazelcast supports several ways including filesystem, classpath, `InputStream` and `URL`:

- `Config cfg = new XmlConfigBuilder(xmlFileName).build();`
- `Config cfg = new XmlConfigBuilder(inputStream).build();`
- `Config cfg = new ClasspathXmlConfig(xmlFileName);`
- `Config cfg = new FileSystemXmlConfig(configFilename);`
- `Config cfg = new UrlXmlConfig(url);`
- `Config cfg = new InMemoryXmlConfig(xml);`

## 4.3. Configuring with System Properties

You can use system properties to configure some aspects of Hazelcast. You set these properties as name and value pairs through declarative configuration, programmatic configuration or JVM system property. Following are examples for each option.

## Declaratively:

```
....
<properties>
  <property name="hazelcast.property.foo">value</property>
  ....
</properties>
</hazelcast>
```

## Programmatically:

```
Config config = new Config() ;
config.setProperty( "hazelcast.property.foo", "value" );
```

## Using JVM's `System` class or `-D` argument:

```
System.setProperty( "hazelcast.property.foo", "value" );
```

or

```
java -Dhazelcast.property.foo=value
```

You will see Hazelcast system properties mentioned throughout this Reference Manual as required in some of the chapters and sections. All Hazelcast system properties are listed in the [System Properties appendix](#) with their descriptions, default values and property types as a reference for you.

## 4.4. Configuring within Spring Context

If you use Hazelcast with [Spring](#) you can declare beans using the namespace `hazelcast`. When you add the namespace declaration to the element `beans` in the Spring context file, you can start to use the namespace shortcut `hz` to be used as a bean declaration. Following is an example Hazelcast configuration when integrated with Spring:

```
<hz:hazelcast id="instance">
  <hz:config>
    <hz:group name="dev"/>
    <hz:network port="5701" port-auto-increment="false">
      <hz:join>
        <hz:multicast enabled="false"/>
        <hz:tcp-ip enabled="true">
          <hz:members>10.10.1.2, 10.10.1.3</hz:members>
        </hz:tcp-ip>
      </hz:join>
    </hz:network>
  </hz:config>
</hz:hazelcast>
```

Please see the [Integration with Spring](#) section for more information on Hazelcast-Spring integration.

## 4.5. Dynamically Adding Data Structure Configuration on a Cluster

As described above, Hazelcast can be configured in a declarative or programmatic way; configuration must be completed before starting a Hazelcast member and this configuration cannot be altered at runtime, thus we refer to this as *static* configuration.

Starting with Hazelcast 3.9, it is possible to dynamically add configuration for certain data structures at runtime; these can be added by invoking one of the `Config.add*Config` methods on the `Config` object obtained from a running member's `HazelcastInstance.getConfig()` method. For example:

```
Config config = new Config();
MapConfig mapConfig = new MapConfig("sessions");
config.addMapConfig(mapConfig);
HazelcastInstance instance = Hazelcast.newHazelcastInstance(config);
MapConfig noBackupsMap = new MapConfig("dont-backup").setBackupCount(0);
instance.getConfig().addMapConfig(noBackupsMap);
```

Dynamic configuration elements must be fully configured before the invocation of `add*Config` method: at that point, the configuration object will be delivered to every member of the cluster and added to each member's dynamic configuration, so mutating the configuration object after the `add*Config` invocation will have no effect.

As dynamically added data structure configuration is propagated across all cluster members, failures may occur due to conditions such as timeout and network partition. The configuration propagation mechanism internally retries adding the configuration whenever a membership change is detected. However if an exception is thrown from `add*Config` method, the configuration may have been partially propagated to some cluster members and adding the configuration should be retried by the user.

Adding new dynamic configuration is supported for all `add*Config` methods except:

- `JobTracker` which has been deprecated since Hazelcast 3.8
- `QuorumConfig`: new quorum configuration cannot be dynamically added but other configuration can reference quorums configured in the existing static configuration
- `WanReplicationConfig`: new WAN replication configuration cannot be dynamically added, however existing static ones can be referenced from other configurations, e.g., a new dynamic `MapConfig` may include a `WanReplicationRef` to a statically configured WAN replication config.
- `ListenerConfig`: listeners can be instead added at runtime via other API such as `HazelcastInstance.getCluster().addMembershipListener` and `HazelcastInstance.getPartitionService().addMigrationListener`.



### 4.5.1. Handling Configuration Conflicts

Attempting to add a dynamic configuration, when a static configuration for the same element already exists, will throw `ConfigurationException`. For example, assuming we start a member with the following fragment in `hazelcast.xml` configuration:

```
<map name="sessions">
  ...
</map>
```

Then adding a dynamic configuration for a map with the name `sessions` will throw a `ConfigurationException`:

```
HazelcastInstance instance = Hazelcast.newHazelcastInstance();

MapConfig sessionsMapConfig = new MapConfig("sessions");

// this will throw ConfigurationException:
instance.getConfig().addMapConfig(sessionsMapConfig);
```

When attempting to add dynamic configuration for an element for which dynamic configuration has already been added, then if a configuration conflict is detected a `ConfigurationException` will be thrown. For example:

```
HazelcastInstance instance = Hazelcast.newHazelcastInstance();

MapConfig sessionsMapConfig = new MapConfig("sessions").setBackupCount(0);
instance.getConfig().addMapConfig(sessionsMapConfig);

MapConfig sessionsWithBackup = new MapConfig("sessions").setBackupCount(1);
// throws ConfigurationException because the new MapConfig conflicts with existing one
instance.getConfig().addMapConfig(sessionsWithBackup);

MapConfig sessionsWithoutBackup = new MapConfig("sessions").setBackupCount(0);
// does not throw exception: new dynamic config is equal to existing dynamic config of
// same name
instance.getConfig().addMapConfig(sessionsWithoutBackup);
```

## 4.6. Checking Configuration

When you start a Hazelcast member without passing a `Config` object, as explained in the [Configuring Programmatically](#) section, Hazelcast checks the member's configuration as follows:

- First, it looks for the `hazelcast.config` system property. If it is set, its value is used as the path. This is useful if you want to be able to change your Hazelcast configuration; you can do this because it is not embedded within the application. You can set the `config` option with the

following command:

```
-Dhazelcast.config='*' <path to the hazelcast.xml>
```

The path can be a regular one or a classpath reference with the prefix `classpath:`.

- If the above system property is not set, Hazelcast then checks whether there is a `hazelcast.xml` file in the working directory.
- If not, it then checks whether `hazelcast.xml` exists on the classpath.
- If none of the above works, Hazelcast loads the default configuration (`hazelcast.xml`) that comes with your Hazelcast package.

Before configuring Hazelcast, please try to work with the default configuration to see if it works for you. This default configuration should be fine for most of the users. If not, you can consider to modify the configuration to be more suitable for your environment.

## 4.7. Configuration Pattern Matcher

You can give a custom strategy to match an item name to a configuration pattern. By default Hazelcast uses a simplified wildcard matching. See [Using Wildcards section](#) for this. A custom configuration pattern matcher can be given by using either member or client `config` objects, as shown below:

```
// Setting a custom config pattern matcher via member config object
Config config = new Config();
config.setConfigPatternMatcher(new ExampleConfigPatternMatcher());
```

And the following is an example pattern matcher:

```
class ExampleConfigPatternMatcher extends MatchingPointConfigPatternMatcher {

    @Override
    public String matches(Iterable<String> configPatterns, String itemName) throws
    ConfigurationException {
        String matches = super.matches(configPatterns, itemName);
        if (matches == null) throw new ConfigurationException("No config found for " +
        itemName);
        return matches;
    }
}
```

## 4.8. Using Wildcards

Hazelcast supports wildcard configuration for all distributed data structures that can be configured using `Config`, that is, for all except `IAtomicLong`, `IAtomicReference`. Using an asterisk (\*) character in

the name, different instances of maps, queues, topics, semaphores, etc. can be configured by a single configuration.

A single asterisk (\*) can be placed anywhere inside the configuration name.

For instance, a map named `com.hazelcast.test.mymap` can be configured using one of the following.

```
<map name="com.hazelcast.test.*">  
...  
</map>
```

```
<map name="com.hazel*">  
...  
</map>
```

```
<map name="*.test.mymap">  
...  
</map>
```

```
<map name="com.*test.mymap">  
...  
</map>
```

Or a queue `com.hazelcast.test.myqueue`:

```
<queue name="*hazelcast.test.myqueue">  
...  
</queue>
```

```
<queue name="com.hazelcast.*.myqueue">  
...  
</queue>
```



- You can use only a single asterisk as a wildcard for each data structure configuration.
- If you have matching wildcard configurations for a data structure, the most specific (longest) one is used when configuring it. Let's say you have a map named `mymap.customer.name` and you have map configurations `mymap.*` and `mymap.customer.*`. Hazelcast uses `mymap.customer.*` to configure this map.

As another example, assume you have a map named `mymap.customer.name` and you have map configurations `mymap.*.name` and `mymap.customer.*`. Hazelcast uses `mymap.customer.*` to configure this map. As you see, the longest character length before the asterisk makes it the most specific, so it wins the configuration.

## 4.9. Using Variables

In your Hazelcast and/or Hazelcast Client declarative configuration, you can use variables to set the values of the elements. This is valid when you set a system property programmatically or you use the command line interface. You can use a variable in the declarative configuration to access the values of the system properties you set.

For example, see the following command that sets two system properties.

```
-Dgroup.name=dev
```

Let's get the values of these system properties in the declarative configuration of Hazelcast, as shown below.

```
<hazelcast>
  <group>
    <name>${group.name}</name>
  </group>
</hazelcast>
```

This also applies to the declarative configuration of Hazelcast Client, as shown below.

```
<hazelcast-client>
  <group>
    <name>${group.name}</name>
  </group>
</hazelcast-client>
```

If you do not want to rely on the system properties, you can use the `XmlConfigBuilder` and explicitly set a `Properties` instance, as shown below.

```

Properties properties = new Properties();

// fill the properties, e.g., from database/LDAP, etc.

XmlConfigBuilder builder = new XmlConfigBuilder();
builder.setProperties(properties);
Config config = builder.build();
HazelcastInstance hz = Hazelcast.newHazelcastInstance(config);

```

## 4.10. Variable Replacers

Variable replacers are used to replace custom strings during loading the configuration, e.g., they can be used to mask sensitive information such as usernames and passwords. Of course their usage is not limited to security related information.

Variable replacers implement the interface `com.hazelcast.config.replacer.spi.ConfigReplacer` and they are configured only declaratively: in the Hazelcast's declarative configuration files, i.e., `hazelcast.xml` and `hazelcast-client.xml`. You can refer to `ConfigReplacer`'s [Javadoc](#) for basic information on how a replacer works.

Variable replacers are configured within the element `<config-replacers>` under `<hazelcast>`, as shown below.

```

<hazelcast>
  ...
  <config-replacers fail-if-value-missing="false">
    <replacer class-name="com.acme.MyReplacer">
      <properties>
        <property name="propName">value</property>
        ...
      </properties>
    </replacer>
    <replacer class-name="example.AnotherReplacer"/>
  </config-replacers>
  ...
</hazelcast>

```

As you can see, `<config-replacers>` is the parent element for your replacers, which are declared using the `<replacer>` sub-elements. You can define multiple replacers under the `<config-replacers>`. Here are the descriptions of elements and attributes used for the replacer configuration:

- `fail-if-value-missing`: Specifies whether the loading configuration process stops when a replacement value is missing. It is an optional attribute and its default value is true.
- `class-name`: Full class name of the replacer.
- `<properties>`: Contains names and values of the properties used to configure a replacer. Each property is defined using the `<property>` sub-element. All of the properties are explained in the

upcoming sections.

The following replacer classes are provided by Hazelcast as example implementations of the `ConfigReplacer` interface. Note that you can also implement your own replacers.

- `EncryptionReplacer`
- `PropertyReplacer`



There is also a `ExecReplacer` which runs an external command and uses its standard output as the value for the variable. Please refer to its [code sample](#).

Each example replacer is explained in the below sections.

### 4.10.1. EncryptionReplacer

This example `EncryptionReplacer` replaces encrypted variables by its plain form. The secret key for encryption/decryption is generated from a password which can be a value in a file and/or environment specific values, such as MAC address and actual user data.

Its full class name is `com.hazelcast.config.replacer.EncryptionReplacer` and the replacer prefix is `ENC`. Here are the properties used to configure this example replacer:

- `cipherAlgorithm`: Cipher algorithm used for the encryption/decryption. Its default value is AES.
- `keyLengthBits`: Length of the secret key to be generated in bits. Its default value is 128 bits.
- `passwordFile`: Path to a file whose content should be used as a part of the encryption password. When the property is not provided no file is used as a part of the password. Its default value is null.
- `passwordNetworkInterface`: Name of network interface whose MAC address should be used as a part of the encryption password. When the property is not provided no network interface property is used as a part of the password. Its default value is null.
- `passwordUserProperties`: Specifies whether the current user properties (`user.name` and `user.home`) should be used as a part of the encryption password. Its default value is true.
- `saltLengthBytes`: Length of a random password salt in bytes. Its default value is 8 bytes.
- `secretKeyAlgorithm`: Name of the secret-key algorithm to be associated with the generated secret key. Its default value is AES.
- `secretKeyFactoryAlgorithm`: Algorithm used to generate a secret key from a password. Its default value is PBKDF2WithHmacSHA256.
- `securityProvider`: Name of a Java Security Provider to be used for retrieving the configured secret key factory and the cipher. Its default value is null.



Older Java versions may not support all the algorithms used as defaults. Please use the property values supported your Java version.

As a usage example, let's create a password file and generate the encrypted strings out of this file.

1 - Create the password file: `echo '/Za-uG3dDfpd,5.-' > /opt/master-password`

2 - Define the encrypted variables:

```
java -cp hazelcast-*.jar \  
  -DpasswordFile=/opt/master-password \  
  -DpasswordUserProperties=false \  
  com.hazelcast.config.replacer.EncryptionReplacer \  
  "aGroup"  
$ENC{Gw45stIlan0=:531:yVN9/xQpJ/Ww3EYkAPvHdA==}  
  
java -cp hazelcast-*.jar \  
  -DpasswordFile=/opt/master-password \  
  -DpasswordUserProperties=false \  
  com.hazelcast.config.replacer.EncryptionReplacer \  
  "aPasswordToEncrypt"  
$ENC{wJxe1vfHTgg=:531:WkAEdSi//YWEbvvVNoU9mUyZ0DE49acJeaJmGalHHfA=}
```

3 - Configure the replacer and put the encrypted variables into the configuration:

```
<hazelcast>  
  <config-replacers>  
    <replacer class-name="com.hazelcast.config.replacer.EncryptionReplacer">  
      <properties>  
        <property name="passwordFile">/opt/master-password</property>  
        <property name="passwordUserProperties">>false</property>  
      </properties>  
    </replacer>  
  </config-replacers>  
  <group>  
    <name>$ENC{Gw45stIlan0=:531:yVN9/xQpJ/Ww3EYkAPvHdA==}</name>  
    <password>  
$ENC{wJxe1vfHTgg=:531:WkAEdSi//YWEbvvVNoU9mUyZ0DE49acJeaJmGalHHfA=}</password>  
    </group>  
</hazelcast>
```

4 - Check if the decryption works:

```
java -jar hazelcast-*.jar  
Apr 06, 2018 10:15:43 AM com.hazelcast.config.XmlConfigLocator  
INFO: Loading 'hazelcast.xml' from working directory.  
Apr 06, 2018 10:15:44 AM com.hazelcast.instance.AddressPicker  
INFO: [LOCAL] [aGroup] [3.10-SNAPSHOT] Prefer IPv4 stack is true.
```

As you can see in the logs, the correctly decrypted group name value ("aGroup") is used.

## 4.10.2. PropertyReplacer

The `PropertyReplacer` replaces variables by properties with the given name. Usually the system

properties are used, e.g., `${user.name}`. There is no need to define it in the declarative configuration files.

Its full class name is `com.hazelcast.config.replacer.PropertyReplacer` and the replacer prefix is empty string (`""`).

### 4.10.3. Implementing Custom Replacers

You can also provide your own replacer implementations. All replacers have to implement the interface `com.hazelcast.config.replacer.spi.ConfigReplacer`. A simple snippet is shown below.

```
public interface ConfigReplacer {
    void init(Properties properties);
    String getPrefix();
    String getReplacement(String maskedValue);
}
```

## 5. Setting Up Clusters

This chapter describes Hazelcast clusters and the methods cluster members and native clients use to form a Hazelcast cluster.

### 5.1. Discovery Mechanisms

A Hazelcast cluster is a network of cluster members that run Hazelcast. Cluster members automatically join together to form a cluster. This automatic joining takes place with various discovery mechanisms that the cluster members use to find each other.

Please note that, after a cluster is formed, communication between cluster members is always via TCP/IP, regardless of the discovery mechanism used.

Hazelcast uses the following discovery mechanisms.



You can refer to the [Hazelcast IMDG Deployment and Operations Guide](#) for advice on the best discovery mechanism to use.

#### 5.1.1. TCP

You can configure Hazelcast to be a full TCP/IP cluster. Please see the [Discovering Members by TCP](#) section for configuration details.

#### 5.1.2. Multicast

Multicast mechanism is not recommended for production since UDP is often blocked in production environments and other discovery mechanisms are more definite.

With this mechanism, Hazelcast allows cluster members to find each other using multicast



communication. Please see the [Discovering Members by Multicast](#) section.

### 5.1.3. AWS Cloud Discovery

Hazelcast supports EC2 auto-discovery. It is useful when you do not want to provide or you cannot provide the list of possible IP addresses. This discovery feature is provided as a Hazelcast plugin. Please see its [documentation](#) for information on configuring and using it.

### 5.1.4. GCP Cloud Discovery

Hazelcast supports discovering members in the [GCP Compute Engine](#) environment. You can easily configure Hazelcast members discovery, WAN replication, and Hazelcast Client to work seamlessly on the native GCP VM Instances. This discovery feature is provided as a Hazelcast plugin. Please see its [documentation](#) for information on configuring and using it.

### 5.1.5. Apache jclouds® Cloud Discovery

Hazelcast members and native clients support jclouds® for discovery. This mechanism allows applications to be deployed in various cloud infrastructure ecosystems in an infrastructure-agnostic way. This discovery feature is provided as a Hazelcast plugin. Please see its [documentation](#) for information on configuring and using it.

### 5.1.6. Azure Cloud Discovery

Hazelcast offers a discovery strategy for your Hazelcast applications running on Azure. This strategy provides all of your Hazelcast instances by returning the virtual machines within your Azure resource group that are tagged with a specified value. This discovery feature is provided as a Hazelcast plugin. Please see its [documentation](#) for information on configuring and using it.

### 5.1.7. Zookeeper Cloud Discovery

This discovery mechanism provides a service based discovery strategy by using Apache Curator to communicate with your Zookeeper server. You can use this plugin with [Discovery SPI](#) enabled Hazelcast 3.6.1 and higher applications. This is provided as a Hazelcast plugin. Please see its [documentation](#) for information on configuring and using it.

### 5.1.8. Consul Cloud Discovery

Consul is a highly available and distributed service discovery and key-value store designed with support for the modern data center to make distributed systems and configuration easy. This mechanism provides a Consul based discovery strategy for Hazelcast enabled applications (Hazelcast 3.6 and higher) and enables Hazelcast members to dynamically discover one another via Consul. This discovery feature is provided as a Hazelcast plugin. Please see its [documentation](#) for information on configuring and using it.

### 5.1.9. etcd Cloud Discovery

This mechanism provides an [etcd](#) based discovery strategy for Hazelcast enabled applications (Hazelcast 3.6 and higher). This is an easy to configure plug-and-play Hazelcast discovery strategy

that will optionally register each of your Hazelcast members with etcd and enable Hazelcast members to dynamically discover one another via etcd. This discovery feature is provided as a Hazelcast plugin. Please see its [documentation](#) for information on configuring and using it.

### 5.1.10. Hazelcast for PCF

Using a clickable Hazelcast Tile for Pivotal Cloud Foundry (PCF), you can deploy your Hazelcast cluster on PCF. This feature is provided as a Hazelcast plugin. Please see its [documentation](#) on how to install, configure and use the plugin Hazelcast for PCF.

### 5.1.11. Hazelcast OpenShift Integration

Hazelcast can run inside OpenShift benefiting from its cluster management software Kubernetes for discovery of members. Using Hazelcast Docker images, templates and default configuration files, you can deploy Hazelcast IMDG, Hazelcast IMDG Enterprise and Management Center onto OpenShift. Please see the documentation:

- [Hazelcast IMDG and Hazelcast IMDG Enterprise](#)
- [Management Center](#)

Please also see the [Hazelcast for OpenShift](#) guide, which presents how to set up local OpenShift environment, start Hazelcast cluster, configure Management Center and finally run a sample client application.

### 5.1.12. Eureka Cloud Discovery

Eureka is a REST based service that is primarily used in the AWS cloud for locating services for the purpose of load balancing and failover of middle-tier servers. Hazelcast supports Eureka V1 discovery; Hazelcast members within EC2 Virtual Private Cloud can discover each other using this mechanism. This discovery feature is provided as a Hazelcast plugin. Please see its [documentation](#).

### 5.1.13. Heroku Cloud Discovery

Heroku is a platform as a service (PaaS) with which you can build, run and operate applications entirely in the cloud. It is a cloud platform based on a managed container system, with integrated data services and a powerful ecosystem. Hazelcast offers a discovery plugin that looks for IP addresses of other members by resolving service names against the Heroku DNS Discovery in Heroku Private Spaces. This discovery feature is provided as a Hazelcast plugin. Please see its [documentation](#).

### 5.1.14. Kubernetes Cloud Discovery

Kubernetes is an open source system for automating deployment, scaling and management of containerized applications. Hazelcast provides Kubernetes discovery mechanism that looks for IP addresses of other members by resolving the requests against a Kubernetes Service Discovery system. It supports two different options of resolving against the discovery registry: (i) a request to the REST API, (ii) DNS Lookup against a given DNS service name. This discovery feature is provided as a Hazelcast plugin. Please see its [documentation](#) for information on configuring and using it.

## 5.2. Discovering Members by TCP

If multicast is not the preferred way of discovery for your environment, then you can configure Hazelcast to be a full TCP/IP cluster. When you configure Hazelcast to discover members by TCP/IP, you must list all or a subset of the members' hostnames and/or IP addresses as cluster members. You do not have to list all of these cluster members, but at least one of the listed members has to be active in the cluster when a new member joins.

To set your Hazelcast to be a full TCP/IP cluster, set the following configuration elements. Please refer to the [tcp-ip element section](#) for the full description of the TCP/IP discovery configuration elements.

- Set the `enabled` attribute of the `multicast` element to "false".
- Set the `enabled` attribute of the `aws` element to "false".
- Set the `enabled` attribute of the `tcp-ip` element to "true".
- Set your `member` elements within the `tcp-ip` element.

The following is an example declarative configuration.

```
<hazelcast>
  ...
  <network>
    ...
    <join>
      <multicast enabled="false">
      </multicast>
      <tcp-ip enabled="true">
        <member>machine1</member>
        <member>machine2</member>
        <member>machine3:5799</member>
        <member>192.168.1.0-7</member>
        <member>192.168.1.21</member>
      </tcp-ip>
      ...
    </join>
    ...
  </network>
  ...
</hazelcast>
```

As shown above, you can provide IP addresses or hostnames for `member` elements. You can also give a range of IP addresses, such as `192.168.1.0-7`.

Instead of providing members line-by-line as shown above, you also have the option to use the `members` element and write comma-separated IP addresses, as shown below.

```
<members>192.168.1.0-7,192.168.1.21</members>
```

If you do not provide ports for the members, Hazelcast automatically tries the ports 5701, 5702 and so on.

By default, Hazelcast binds to all local network interfaces to accept incoming traffic. You can change this behavior using the system property `hazelcast.socket.bind.any`. If you set this property to `false`, Hazelcast uses the interfaces specified in the `interfaces` element (please refer to the [Interfaces Configuration section](#)). If no interfaces are provided, then it will try to resolve one interface to bind from the `member` elements.

## 5.3. Discovering Members by Multicast

With the multicast auto-discovery mechanism, Hazelcast allows cluster members to find each other using multicast communication. The cluster members do not need to know the concrete addresses of the other members, as they just multicast to all the other members for listening. Whether multicast is possible or allowed depends on your environment.

To set your Hazelcast to multicast auto-discovery, set the following configuration elements. Please refer to the [multicast element section](#) for the full description of the multicast discovery configuration elements.

- Set the `enabled` attribute of the `multicast` element to "true".
- Set `multicast-group`, `multicast-port`, `multicast-time-to-live`, etc. to your multicast values.
- Set the `enabled` attribute of both `tcp-ip` and `aws` elements to "false".

The following is an example declarative configuration.

```
<hazelcast>
  ...
  <network>
    ...
    <join>
      <multicast enabled="true">
        <multicast-group>224.2.2.3</multicast-group>
        <multicast-port>54327</multicast-port>
        <multicast-time-to-live>32</multicast-time-to-live>
        <multicast-timeout-seconds>2</multicast-timeout-seconds>
        <trusted-interfaces>
          <interface>192.168.1.102</interface>
        </trusted-interfaces>
      </multicast>
      <tcp-ip enabled="false">
      </tcp-ip>
      <aws enabled="false">
      </aws>
    </join>
  </network>
```

Pay attention to the `multicast-timeout-seconds` element. `multicast-timeout-seconds` specifies the

time in seconds that a member should wait for a valid multicast response from another member running in the network before declaring itself the leader member (the first member joined to the cluster) and creating its own cluster. This only applies to the startup of members where no leader has been assigned yet. If you specify a high value to `multicast-timeout-seconds`, such as 60 seconds, it means that until a leader is selected, each member will wait 60 seconds before moving on. Be careful when providing a high value. Also, be careful not to set the value too low, or the members might give up too early and create their own cluster.



Multicast auto-discovery is not supported for Hazelcast native clients yet. However, we offer Multicast Discovery Plugin for this purpose. Please refer to the [Discovering Native Clients](#) section.

## 5.4. Discovering Native Clients

Hazelcast members and native Java clients can find each other with multicast discovery plugin. This plugin is implemented using [Hazelcast Discovery SPI](#). You should configure the plugin both at Hazelcast members and Java clients in order to use multicast discovery.

To configure your cluster to have the multicast discovery plugin, follow these steps:

- Disable the multicast and TCP/IP join mechanisms. To do this, set the `enabled` attributes of the `multicast` and `tcp-ip` elements to `false` in your `hazelcast.xml` configuration file
- Set the `enabled` attribute of the `hazelcast.discovery.enabled` property to `true`.
- Add multicast discovery strategy configuration to your XML file, i.e., `<discovery-strategies>` element.

The following is an example declarative configuration.

```

...
<properties>
  <property name="hazelcast.discovery.enabled">true</property>
</properties>
....
<join>
  <multicast enabled="false">
</multicast>
  <tcp-ip enabled="false">
</tcp-ip>
  <discovery-strategies>
    <discovery-strategy class=
"com.hazelcast.spi.discovery.multicast.MulticastDiscoveryStrategy" enabled="true">
      <properties>
        <property name="group">224.2.2.3</property>
        <property name="port">54327</property>
      </properties>
    </discovery-strategy>
  </discovery-strategies>
</join>
...

```

The following are the multicast discovery plugin configuration properties with their descriptions.

- **group**: String value that is used to set the multicast group, so that you can isolate your clusters.
- **port**: Integer value that is used to set the multicast port.

## 5.5. Creating Cluster Groups

You can create cluster groups. To do this, use the **group** configuration element.

You can separate your clusters in a simple way by specifying group names. Example groupings can be by **development**, **production**, **test**, **app**, etc. The following is an example declarative configuration.

```

<hazelcast>
  <group>
    <name>production</name>
  </group>
  ...
</hazelcast>

```

You can also define the cluster groups using the programmatic configuration. A JVM can host multiple Hazelcast instances. Each Hazelcast instance can only participate in one group. Each Hazelcast instance only joins to its own group and does not interact with other groups. The following code example creates three separate Hazelcast instances--**h1** belongs to the **production** cluster, while **h2** and **h3** belong to the **development** cluster.

```

Config configProd = new Config();
configProd.getGroupConfig().setName( "production" );

Config configDev = new Config();
configDev.getGroupConfig().setName( "development" );

HazelcastInstance h1 = Hazelcast.newHazelcastInstance( configProd );
HazelcastInstance h2 = Hazelcast.newHazelcastInstance( configDev );
HazelcastInstance h3 = Hazelcast.newHazelcastInstance( configDev );

```

### 5.5.1. Cluster Groups before Hazelcast 3.8.2

If you have a Hazelcast release older than 3.8.2, you need to provide also a group password along with the group name. The following are the configuration examples with the password element:

```

<hazelcast>
  <group>
    <name>production</name>
    <password>prod-pass</password>
  </group>
  ...
</hazelcast>

```

```

Config configProd = new Config();
configProd.getGroupConfig().setName( "production" ).setPassword( "prod-pass" );

Config configDev = new Config();
configDev.getGroupConfig().setName( "development" ).setPassword( "dev-pass" );

HazelcastInstance h1 = Hazelcast.newHazelcastInstance( configProd );
HazelcastInstance h2 = Hazelcast.newHazelcastInstance( configDev );
HazelcastInstance h3 = Hazelcast.newHazelcastInstance( configDev );

```



Starting with 3.8.2, members no longer perform a password check during the cluster join process. Starting with 3.11, members no longer perform a password check when a client connects to the cluster.

## 5.6. Member User Code Deployment - BETA

Hazelcast can dynamically load your custom classes or domain classes from a remote class repository, which typically includes [lite members](#). For this purpose Hazelcast offers a distributed dynamic class loader.

Using this dynamic class loader, you can control the local caching of the classes loaded from other members, control the classes to be served to other members and create blacklists or whitelists of

classes and packages. When you enable this feature, you will not have to deploy your classes to all cluster members.

The following is the brief working mechanism of the User Code Deployment feature:

1. Dynamic class loader first checks the local classes, i.e., your classpath, for your custom class. If it is there, Hazelcast does not try to load it from the remote class repository.
2. Then, it checks the cache of classes loaded from the remote class repository (for this, caching should have been enabled in your local, please refer to [Configuring User Code Deployment section](#)). If your class is found here, again, Hazelcast does not try to load it from the remote class repository.
3. Finally, dynamic class loader checks the remote class repository. If a member in this repository returns the class, it means your class is found and will be used. You can also put this class into your local class cache as mentioned in the previous step.

### 5.6.1. Configuring User Code Deployment

User Code Deployment feature is not enabled by default. You can configure this feature declaratively or programmatically. Following are example configuration snippets:

#### Declarative Configuration

```
<user-code-deployment enabled="true">
  <class-cache-mode>ETERNAL</class-cache-mode>
  <provider-mode>LOCAL_CLASSES_ONLY</provider-mode>
  <blacklist-prefixes>com.foo</blacklist-prefixes>
  <whitelist-prefixes>com.bar.MyClass</whitelist-prefixes>
  <provider-filter>HAS_ATTRIBUTE:lite</provider-filter>
</user-code-deployment>
```

#### Programmatic Configuration

```
Config config = new Config();
UserCodeDeploymentConfig distCLConfig = config.getUserCodeDeploymentConfig();
distCLConfig.setEnabled( true )
    .setClassCacheMode( UserCodeDeploymentConfig.ClassCacheMode.ETERNAL )
    .setProviderMode( UserCodeDeploymentConfig.ProviderMode.LOCAL_CLASSES_ONLY )
    .setBlacklistedPrefixes( "com.foo" )
    .setWhitelistedPrefixes( "com.bar.MyClass" )
    .setProviderFilter( "HAS_ATTRIBUTE:lite" );
```

User Code Deployment has the following configuration elements and attributes:

- **enabled**: Specifies whether dynamic class loading is enabled or not. Its default value is "false" and it is a mandatory attribute.
- **<class-cache-mode>**: Controls the local caching behavior for the classes loaded from the remote class repository. Available values are as follows:



- **ETERNAL**: Cache the loaded classes locally. This is the default value and suitable when you load long-living objects, such as domain objects stored in a map.
- **OFF**: Do not cache the loaded classes locally. It is suitable for loading runnables, callables, entry processors, etc.
- **<provider-mode>**: Controls how the classes are served to the other cluster members. Available values are as follows:
  - **LOCAL\_AND\_CACHED\_CLASSES**: Serve classes loaded from both local classpath and from other members. This is the default value.
  - **LOCAL\_CLASSES\_ONLY**: Serve classes from the local classpath only. Classes loaded from other members will be used locally, but they are not served to other members.
  - **OFF**: Never serve classes to other members.
- **<blacklist-prefixes>**: Comma separated name prefixes of classes/packages to be prevented from dynamic class loading. For example, if you set it as "com.foo", remote loading of all classes from the "com.foo" package will be blacklisted, including the classes from all its sub-packages. If you set it as "com.foo.Class", then the "Class" and all classes having the "Class" as prefix in the "com.foo" package will be blacklisted. There are some built-in prefixes which are blacklisted by default. These are as follows:
  - **javax.**
  - **java.**
  - **sun.**
  - **com.hazelcast.**
- **<whitelist-prefixes>**: Comma separated name prefixes of classes/packages only from which the classes will be loaded. It allows to quickly configure remote loading only for classes from selected packages. It can be used together with blacklisting. For example, you can whitelist the prefix "com.foo" and blacklist the prefix "com.foo.secret".
- **<provider-filter>**: Filter to constraint members to be used for a class loading request when a class is not available locally. The value is in the format "HAS\_ATTRIBUTE:foo". When it is set as "HAS\_ATTRIBUTE:foo", the class loading request will only be sent to the members which have "foo" as a [member attribute](#). Setting this to null will allow to load classes from all members. Please see an example in the below section.

### 5.6.2. Example for Filtering Members

As described above, the configuration element **provider-filter** is used to constrain a member to load classes only from a subset of all cluster members. The value of the **provider-filter** must be set as a member attribute in the desired members from which the classes will be loaded. Please see the following example usage provided as programmatic configurations.

The below example configuration will allow the Hazelcast member to load classes only from members with the **class-provider** attribute set. It will not ask any other member to provide a locally unavailable class:

```
Config hazelcastConfig = new Config();
DistributedClassloadingConfig distributedClassloadingConfig = hazelcastConfig
    .getDistributedClassloadingConfig();
distributedClassloadingConfig.setProviderFilter("HAS_ATTRIBUTE:class-provider");

HazelcastInstance instance = Hazelcast.newHazelcastInstance(hazelcastConfig);
```

And the below example configuration sets the attribute `class-provider` for a member. So, the above member will load classes from the members who have the attribute `class-provider`:

```
Config hazelcastConfig = new Config();
MemberAttributeConfig memberAttributes = hazelcastConfig.getMemberAttributeConfig();
memberAttributes.setAttribute("class-provider", "true");

HazelcastInstance instance = Hazelcast.newHazelcastInstance(hazelcastConfig);
```

## 5.7. Client User Code Deployment - BETA

You can use the User Code Deployment at the client side for the following situations:

1. You have objects that will run on the cluster via the clients such as `Runnable`, `Callable` and `EntryProcessors`.
2. You have new or amended user domain objects (in-memory format of the `IMap` set to `Object`) which need to be deployed into the cluster.

When this feature is enabled, the clients will deploy these classes to the members. By this way, when a client adds a new class, the members will not require restarts to include the new classes in classpath.

You can also use the client permission policy to specify which clients are permitted to use User Code Deployment. Please see the [Permissions](#).

### 5.7.1. Configuring Client User Code Deployment

Client User Code Deployment feature is not enabled by default. You can configure this feature declaratively or programmatically. Following are example configuration snippets:

#### Declarative Configuration

In your `hazelcast-client.xml`:

```

<user-code-deployment enabled="true">
  <jarPaths>
    <jarPath>/User/sample/sample.jar</jarPath>
    <jarPath>sample.jar</jarPath> <!--from class path -->
    <jarPath>https://com.sample.com/sample.jar</jarPath>
    <jarPath>file://Users/sample/sample.jar</jarPath>
  </jarPaths>
  <classNames>
    <!-- for the classes available in client class path -->
    <className>sample.ClassName</className>
    <className>sample.ClassName2</className>
  </classNames>
</user-code-deployment>

```

## Programmatic Configuration

```

ClientConfig clientConfig = new ClientConfig();
ClientUserCodeDeploymentConfig clientUserCodeDeploymentConfig = new
ClientUserCodeDeploymentConfig();

clientUserCodeDeploymentConfig.addJar("/User/sample/sample.jar");
clientUserCodeDeploymentConfig.addJar("https://com.sample.com/sample.jar");
clientUserCodeDeploymentConfig.addClass("sample.ClassName");
clientUserCodeDeploymentConfig.addClass("sample.ClassName2");

clientUserCodeDeploymentConfig.setEnabled(true);
clientConfig.setUserCodeDeploymentConfig(clientUserCodeDeploymentConfig);

```

## Important to Know

Note that User Code Deployment should also be enabled on the members to use this feature.

```

Config config = new Config();
UserCodeDeploymentConfig userCodeDeploymentConfig = config.
getUserCodeDeploymentConfig();
userCodeDeploymentConfig.setEnabled( true );

```

Please refer to the [Member User Code Deployment section](#) for more information on enabling it on the member side and its configuration properties.

For the property `class-cache-mode`, Client User Code Deployment supports only the `ETERNAL` mode, regardless of the configuration set at the member side (which can be `ETERNAL` and `OFF`).

For the property, `provider-mode`, Client User Code Deployment supports only the `LOCAL_AND_CACHED_CLASSES` mode, regardless of the configuration set at the member side (which can be `LOCAL_AND_CACHED_CLASSES`, `LOCAL_CLASSES_ONLY` and `OFF`).

The remaining properties, which are `blacklist-prefixes`, `whitelist-prefixes` and `provider-filter` configured at the member side, will effect the client user code deployment's behavior too. For example, assuming that you provide `com.foo` as a blacklist prefix at the member side, the member will discard the classes with the prefix `com.foo` loaded by the client.

### 5.7.2. Adding User Library to CLASSPATH

When you want to use a Hazelcast feature in a non-Java client, you need to make sure that the Hazelcast member recognizes it. For this, you can use the `/user-lib` directory that comes with the Hazelcast package and deploy your own library to the member. Let's say you use Hazelcast Node.js client and want to use an entry processor. This processor should be `IdentifiedDataSerializable` or `Portable` in the Node.js client. You need to implement the Java equivalents of the processor and its factory on the member side, and put these compiled class or JAR files into the `/user-lib` directory. Then you can run the `start.sh` script which adds them to the classpath.

The following is an example code which can be the Java equivalent of entry processor in Node.js client:

```

import com.hazelcast.map.AbstractEntryProcessor;
import com.hazelcast.nio.ObjectDataInput;
import com.hazelcast.nio.ObjectDataOutput;
import com.hazelcast.nio.serialization.IdentifiedDataSerializable;
import java.io.IOException;
import java.util.Map;
public class IdentifiedEntryProcessor extends AbstractEntryProcessor<String, String>
implements IdentifiedDataSerializable {
    static final int CLASS_ID = 1;
    private String value;
    public IdentifiedEntryProcessor() {
    }
    @Override
    public int getFactoryId() {
        return IdentifiedFactory.FACTORY_ID;
    }
    @Override
    public int getId() {
        return CLASS_ID;
    }
    @Override
    public void writeData(ObjectDataOutput out) throws IOException {
        out.writeUTF(value);
    }
    @Override
    public void readData(ObjectDataInput in) throws IOException {
        value = in.readUTF();
    }
    @Override
    public Object process(Map.Entry<String, String> entry) {
        entry.setValue(value);
        return value;
    }
}

```

You can implement the above processor's factory as follows:

```

import com.hazelcast.nio.serialization.DataSerializableFactory;
import com.hazelcast.nio.serialization.IdentifiedDataSerializable;
public class IdentifiedFactory implements DataSerializableFactory {
    public static final int FACTORY_ID = 5;
    @Override
    public IdentifiedDataSerializable create(int typeId) {
        if (typeId == IdentifiedEntryProcessor.CLASS_ID) {
            return new IdentifiedEntryProcessor();
        }
        return null;
    }
}

```

And the following is the configuration for the above factory:

```

<hazelcast>
  <serialization>
    <data-serializable-factories>
      <data-serializable-factory factory-id="5">
        IdentifiedFactory
      </data-serializable-factory>
    </data-serializable-factories>
  </serialization>
</hazelcast>

```

Then, you can start your Hazelcast member by using the start scripts (`start.sh` or `start.bat`) in the `/bin` directory. The start scripts automatically adds your class and JAR files to the classpath.

## 5.8. Partition Group Configuration

Hazelcast distributes key objects into partitions using the consistent hashing algorithm. Multiple replicas are created for each partition and those partition replicas are distributed among Hazelcast members. An entry is stored in the members that own replicas of the partition to which the entry's key is assigned. The total partition count is 271 by default; you can change it with the configuration property `hazelcast.partition.count`. Please see the [System Properties appendix](#).

Hazelcast member that owns the primary replica of a partition is called as partition owner. Other replicas are called backups. Based on the configuration, a key object can be kept in multiple replicas of a partition. A member can hold at most one replica of a partition (ownership or backup).

By default, Hazelcast distributes partition replicas randomly and equally among the cluster members, assuming all members in the cluster are identical. But what if some members share the same JVM or physical machine or chassis and you want backups of these members to be assigned to members in another machine or chassis? What if processing or memory capacities of some members are different and you do not want an equal number of partitions to be assigned to all members?

To deal with such scenarios, you can group members in the same JVM (or physical machine) or members located in the same chassis. Or you can group members to create identical capacity. We call these groups **partition groups**. Partitions are assigned to those partition groups instead of individual members. Backup replicas of a partition which is owned by a partition group are located in other partition groups.

### 5.8.1. Grouping Types

When you enable partition grouping, Hazelcast presents the following choices for you to configure partition groups.

#### HOST\_AWARE

You can group members automatically using the IP addresses of members, so members sharing the same network interface will be grouped together. All members on the same host (IP address or domain name) will be a single partition group. This helps to avoid data loss when a physical server crashes, because multiple replicas of the same partition are not stored on the same host. But if there are multiple network interfaces or domain names per physical machine, that will make this assumption invalid.

Following are declarative and programmatic configuration snippets that show how to enable HOST\_AWARE grouping.

```
<partition-group enabled="true" group-type="HOST_AWARE" />
```

```
Config config = ...;
PartitionGroupConfig partitionGroupConfig = config.getPartitionGroupConfig();
partitionGroupConfig.setEnabled( true )
    .setGroupType( MemberGroupType.HOST_AWARE );
```

#### CUSTOM

You can do custom grouping using Hazelcast's interface matching configuration. This way, you can add different and multiple interfaces to a group. You can also use wildcards in the interface addresses. For example, the users can create rack-aware or data warehouse partition groups using custom partition grouping.

Following are declarative and programmatic configuration examples that show how to enable and use CUSTOM grouping.

```

<partition-group enabled="true" group-type="CUSTOM">
  <member-group>
    <interface>10.10.0.*</interface>
    <interface>10.10.3.*</interface>
    <interface>10.10.5.*</interface>
  </member-group>
  <member-group>
    <interface>10.10.10.10-100</interface>
    <interface>10.10.1.*</interface>
    <interface>10.10.2.*</interface>
  </member-group>
</partition-group>

```

```

Config config = new Config();
PartitionGroupConfig partitionGroupConfig = config.getPartitionGroupConfig();
partitionGroupConfig.setEnabled( true )
    .setGroupType( PartitionGroupConfig.MemberGroupType.CUSTOM );

MemberGroupConfig memberGroupConfig = new MemberGroupConfig();
memberGroupConfig.addInterface( "10.10.0.*" )
    .addInterface( "10.10.3.*" ).addInterface("10.10.5.*" );

MemberGroupConfig memberGroupConfig2 = new MemberGroupConfig();
memberGroupConfig2.addInterface( "10.10.10.10-100" )
    .addInterface( "10.10.1.*" ).addInterface( "10.10.2.*" );

partitionGroupConfig.addMemberGroupConfig( memberGroupConfig );
partitionGroupConfig.addMemberGroupConfig( memberGroupConfig2 );

```



While your cluster was forming, if you configured your members to discover each other by their IP addresses, you should use the IP addresses for the `<interface>` element. If your members discovered each other by their hostnames, you should use the hostnames.

## PER\_MEMBER

You can give every member its own group. Each member is a group of its own and primary and backup partitions are distributed randomly (not on the same physical member). This gives the least amount of protection and is the default configuration for a Hazelcast cluster. This grouping type provides good redundancy when Hazelcast members are on separate hosts. However, if multiple instances run on the same host, this type is not a good option.

Following are declarative and programmatic configuration snippets that show how to enable PER\_MEMBER grouping.

```

<partition-group enabled="true" group-type="PER_MEMBER" />

```



```
Config config = ...;
PartitionGroupConfig partitionGroupConfig = config.getPartitionGroupConfig();
partitionGroupConfig.setEnabled( true )
    .setGroupType( MemberGroupType.PER_MEMBER );
```

## ZONE\_AWARE

You can use ZONE\_AWARE configuration with [Hazelcast AWS](#), [Hazelcast GCP](#), [Hazelcast jclouds](#) or [Hazelcast Azure](#) Discovery Service plugins.

As discovery services, these plugins put zone information to the Hazelcast [member attributes](#) map during the discovery process. When ZONE\_AWARE is configured as partition group type, Hazelcast creates the partition groups with respect to member attributes map entries that include zone information. That means backups are created in the other zones and each zone will be accepted as one partition group.



When using the ZONE\_AWARE partition grouping, a Hazelcast cluster spanning multiple AZs should have an equal number of members in each AZ. Otherwise, it will result in uneven partition distribution among the members.

This is the list of supported attributes which is set by Discovery Service plugins during a Hazelcast member start-up:

- `hazelcast.partition.group.zone`: For the zones in the same area.
- `hazelcast.partition.group.rack`: For different racks in the same zone.
- `hazelcast.partition.group.host`: For a shared physical member if virtualization is used.



`hazelcast-jclouds` offers rack or host information in addition to zone information based on cloud provider. In such cases, Hazelcast looks for zone, rack and host information in the given order and create partition groups with available information\*

Following are declarative and programmatic configuration snippets that show how to enable ZONE\_AWARE grouping.

```
<partition-group enabled="true" group-type="ZONE_AWARE" />
```

```
Config config = ...;
PartitionGroupConfig partitionGroupConfig = config.getPartitionGroupConfig();
partitionGroupConfig.setEnabled( true )
    .setGroupType( MemberGroupType.ZONE_AWARE );
```

## SPI

You can provide your own partition group implementation using the SPI configuration. To create

your partition group implementation, you need to first extend the `DiscoveryStrategy` class of the discovery service plugin, override the method `public PartitionGroupStrategy getPartitionGroupStrategy()` and return the `PartitionGroupStrategy` configuration in that overridden method.

Following is a sample code covering the implementation steps mentioned in the above paragraph:

```
public class CustomDiscovery extends AbstractDiscoveryStrategy {

    public CustomDiscovery(ILogger logger, Map<String, Comparable> properties) {
        super(logger, properties);
    }

    @Override
    public Iterable<DiscoveryNode> discoverNodes() {
        Iterable<DiscoveryNode> iterable = //your implementation
        return iterable;
    }

    @Override
    public PartitionGroupStrategy getPartitionGroupStrategy() {
        return new CustomPartitionGroupStrategy();
    }

    private class CustomPartitionGroupStrategy implements PartitionGroupStrategy {
        @Override
        public Iterable<MemberGroup> getMemberGroups() {
            Iterable<MemberGroup> iterable = //your implementation
            return iterable;
        }
    }
}
```

## 5.9. Logging Configuration

Hazelcast has a flexible logging configuration and does not depend on any logging framework except JDK logging. It has built-in adapters for a number of logging frameworks and it also supports custom loggers by providing logging interfaces.

To use built-in adapters, set the `hazelcast.logging.type` property to one of the predefined types below.

- **jdk**: JDK logging (default)
- **log4j**: Log4j
- **log4j2**: Log4j2
- **slf4j**: Slf4j
- **none**: disable logging

You can set `hazelcast.logging.type` through declarative configuration, programmatic configuration, or JVM system property.



If you choose to use `log4j`, `log4j2`, or `slf4j`, you should include the proper dependencies in the classpath.

## Declarative Configuration

```
....
<properties>
  <property name="hazelcast.logging.type">log4j</property>
  ....
</properties>
</hazelcast>
```

## Programmatic Configuration

```
Config config = new Config() ;
config.setProperty( "hazelcast.logging.type", "log4j" );
```

## System Property

- Using JVM parameter: `java -Dhazelcast.logging.type=slf4j`
- Using System class: `System.setProperty( "hazelcast.logging.type", "none" );`

If the provided logging mechanisms are not satisfactory, you can implement your own using the custom logging feature. To use it, implement the `com.hazelcast.logging.LoggerFactory` and `com.hazelcast.logging.ILogger` interfaces and set the system property `hazelcast.logging.class` as your custom `LoggerFactory` class name.

```
-Dhazelcast.logging.class=foo.bar.MyLoggingFactory
```

You can also listen to logging events generated by Hazelcast runtime by registering `LogListeners` to `LoggingService`.

```
LogListener listener = new LogListener() {
    public void log( LogEvent logEvent ) {
        // do something
    }
};
HazelcastInstance instance = Hazelcast.newHazelcastInstance();
LoggingService loggingService = instance.getLoggingService();
loggingService.addLogListener( Level.INFO, listener );
```

Through the `LoggingService`, you can get the currently used `ILogger` implementation and log your

own messages too.



If you are not using command line for configuring logging, you should be careful about Hazelcast classes. They may be defaulted to `jdk` logging before newly configured logging is read. When logging mechanism is selected, it will not change.

Below are example configurations for Log4j2 and Log4j. Note that Hazelcast does not recommend any specific logging library, these examples are provided only to demonstrate how to configure the logging. You can use your custom logging as explained above.

### 5.9.1. Example Log4j2 Configuration

Specify the logging type as Log4j2 and a separate logging configuration file as shown below.

Using JVM arguments:

```
-Dhazelcast.logging.type=log4j2  
-Dlog4j.configurationFile=/path/to/properties/log4j2.properties
```

Using declarative configuration (`hazelcast.xml`):

```
<hazelcast>  
  ...  
  <properties>  
    <property name="hazelcast.logging.type">log4j2</property>  
    <property name="log4j2.configuration">/path/to/properties/log4j2.properties<  
  /property>  
    ...  
  </properties>  
  ...  
</hazelcast>
```

Following is an example `log4j2.properties` file:

```

rootLogger=file
rootLogger.level=info
property.filepath=/path/to/log/files
property.filename=hazelcast

appender.file.type=RollingFile
appender.file.name=RollingFile
appender.file.fileName=${filepath}/${filename}.log
appender.file.filePattern=${filepath}/${filename}-${d{yyyy-MM-dd}}-i.log.gz
appender.file.layout.type=PatternLayout
appender.file.layout.pattern = %d{yyyy-MM-dd HH:mm:ss} %-5p %c{1}:%L - %m%n
appender.file.policies.type=Policies
appender.file.policies.time.type=TimeBasedTriggeringPolicy
appender.file.policies.time.interval=1
appender.file.policies.time.modulate=true
appender.file.policies.size.type=SizeBasedTriggeringPolicy
appender.file.policies.size.size=50MB
appender.file.strategy.type=DefaultRolloverStrategy
appender.file.strategy.max=100

rootLogger.appenderRefs=file
rootLogger.appenderRef.file.ref=RollingFile

#Hazelcast specific logs.

#log4j.logger.com.hazelcast=debug

#log4j.logger.com.hazelcast.cluster=debug
#log4j.logger.com.hazelcast.partition=debug
#log4j.logger.com.hazelcast.partition.InternalPartitionService=debug
#log4j.logger.com.hazelcast.nio=debug
#log4j.logger.com.hazelcast.hibernate=debug

```

To enable the debug logs for all Hazelcast operations uncomment the below line in the above configuration file:

```
log4j.logger.com.hazelcast=debug
```

If you do not need detailed logs, the default settings is enough. Using the Hazelcast specific lines in the above configuration file, you can select to see specific logs (cluster, partition, hibernate, etc.) in desired levels.

### 5.9.2. Example Log4j Configuration

Its configuration is similar to that of Log4j2. Below is the JVM argument way of specifying the logging type and configuration file:

```
-Dhazelcast.logging.type=log4j
-Dlog4j.configuration=file:/path/to/properties/log4j.properties
```

Following is an example `log4j.properties` file:

```
log4j.rootLogger=INFO,file

log4j.appender.file=org.apache.log4j.RollingFileAppender
log4j.appender.file.File=/path/to/log/files/hazelcast.log
log4j.appender.file.layout=org.apache.log4j.PatternLayout
log4j.appender.file.layout.ConversionPattern=%d{yyyy-MM-dd HH:mm:ss} %p [%c{1}] - %m%n
log4j.appender.file.maxFileSize=50MB
log4j.appender.file.maxBackupIndex=100
log4j.appender.file.threshold=DEBUG

#log4j.logger.com.hazelcast=debug

#log4j.logger.com.hazelcast.cluster=debug
#log4j.logger.com.hazelcast.partition=debug
#log4j.logger.com.hazelcast.partition.InternalPartitionService=debug
#log4j.logger.com.hazelcast.nio=debug
#log4j.logger.com.hazelcast.hibernate=debug
```

## 5.10. Other Network Configurations

All network related configurations are performed via the `network` element in the Hazelcast XML configuration file or the class `NetworkConfig` when using programmatic configuration. Following subsections describe the available configurations that you can perform under the `network` element.

### 5.10.1. Public Address

`public-address` overrides the public address of a member. By default, a member selects its socket address as its public address. But behind a network address translation (NAT), two endpoints (members) may not be able to see/access each other. If both members set their public addresses to their defined addresses on NAT, then that way they can communicate with each other. In this case, their public addresses are not an address of a local network interface but a virtual address defined by NAT. It is optional to set and useful when you have a private cloud. Note that, the value for this element should be given in the format `host IP address:port number`. See the following examples.

#### Declarative:

```
<network>
  <public-address>11.22.33.44:5555</public-address>
</network>
```

#### Programmatic:

```
Config config = new Config();
config.getNetworkConfig()
    .setPublicAddress( "11.22.33.44:5555" );
```

### 5.10.2. Port

You can specify the ports that Hazelcast will use to communicate between cluster members. Its default value is **5701**. The following are example configurations.

#### Declarative:

```
<network>
  <port port-count="20" auto-increment="true">5701</port>
</network>
```

#### Programmatic:

```
Config config = new Config();
config.getNetworkConfig().setPort( 5701 )
    .setPortAutoIncrement( true ).setPortCount( 20 );
```

According to the above example, Hazelcast will try to find free ports between 5701 and 5720.

**port** has the following attributes.

- **port-count**: By default, Hazelcast will try 100 ports to bind. Meaning that, if you set the value of port as 5701, as members are joining to the cluster, Hazelcast tries to find ports between 5701 and 5801. You can choose to change the port count in the cases like having large instances on a single machine or willing to have only a few ports to be assigned. The parameter **port-count** is used for this purpose, whose default value is 100.
- **auto-increment**: In some cases you may want to choose to use only one port. In that case, you can disable the auto-increment feature of **port** by setting **auto-increment** to **false**. The **port-count** attribute is not used when auto-increment feature is disabled.

### 5.10.3. Outbound Ports

By default, Hazelcast lets the system pick up an ephemeral port during socket bind operation. But security policies/firewalls may require you to restrict outbound ports to be used by Hazelcast-enabled applications. To fulfill this requirement, you can configure Hazelcast to use only defined outbound ports. The following are example configurations.

#### Declarative:

```

<network>
  <outbound-ports>
    <!-- ports between 33000 and 35000 -->
    <ports>33000-35000</ports>
    <!-- comma separated ports -->
    <ports>37000,37001,37002,37003</ports>
    <ports>38000,38500-38600</ports>
  </outbound-ports>
</network>

```

### Programmatic:

```

...
NetworkConfig networkConfig = config.getNetworkConfig();
// ports between 35000 and 35100
networkConfig.addOutboundPortDefinition("35000-35100");
// comma separated ports
networkConfig.addOutboundPortDefinition("36001, 36002, 36003");
networkConfig.addOutboundPort(37000);
networkConfig.addOutboundPort(37001);
...

```



You can use port ranges and/or comma separated ports.

As shown in the programmatic configuration, you use the method `addOutboundPort` to add only one port. If you need to add a group of ports, then use the method `addOutboundPortDefinition`.

In the declarative configuration, the element `ports` can be used for both single and multiple port definitions. When you set this element to `0` or `*`, your operating system (not Hazelcast) will select a free port from the ephemeral range.

#### 5.10.4. Reuse Address

When you shutdown a cluster member, the server socket port will be in the `TIME_WAIT` state for the next couple of minutes. If you start the member right after shutting it down, you may not be able to bind it to the same port because it is in the `TIME_WAIT` state. If you set the `reuse-address` element to `true`, the `TIME_WAIT` state is ignored and you can bind the member to the same port again.

The following are example configurations.

### Declarative:

```

<network>
  <reuse-address>true</reuse-address>
</network>

```

### Programmatic:



```

...
NetworkConfig networkConfig = config.getNetworkConfig();

networkConfig.setReuseAddress( true );

...

```

### 5.10.5. Join

The `join` configuration element is used to discover Hazelcast members and enable them to form a cluster. Hazelcast provides multicast, TCP/IP, EC2 and jclouds® discovery mechanisms. These mechanisms are explained the [Discovery Mechanisms section](#). This section describes all the sub-elements and attributes of `join` element. The following are example configurations.

#### Declarative:

```

<network>
  <join>
    <multicast enabled="true">
      <multicast-group>224.2.2.3</multicast-group>
      <multicast-port>54327</multicast-port>
      <multicast-time-to-live>32</multicast-time-to-live>
      <multicast-timeout-seconds>2</multicast-timeout-seconds>
      <trusted-interfaces>
        <interface>192.168.1.102</interface>
      </trusted-interfaces>
    </multicast>
    <tcp-ip enabled="false">
      <required-member>192.168.1.104</required-member>
      <member>192.168.1.104</member>
      <members>192.168.1.105, 192.168.1.106</members>
    </tcp-ip>
    <aws enabled="false">
      <access-key>my-access-key</access-key>
      <secret-key>my-secret-key</secret-key>
      <region>us-west-1</region>
      <host-header>ec2.amazonaws.com</host-header>
      <security-group-name>hazelcast-sg</security-group-name>
      <tag-key>type</tag-key>
      <tag-value>hz-members</tag-value>
    </aws>
    <discovery-strategies>
      <discovery-strategy ... />
    </discovery-strategies>
  </join>
</network>

```

#### Programmatic:

```
Config config = new Config();
NetworkConfig network = config.getNetworkConfig();
JoinConfig join = network.getJoin();
join.getMulticastConfig().setEnabled( false )
    .addTrustedInterface( "192.168.1.102" );
join.getTcpIpConfig().addMember( "10.45.67.32" ).addMember( "10.45.67.100" )
    .setRequiredMember( "192.168.10.100" ).setEnabled( true );
```

The `join` element has the following sub-elements and attributes.

### multicast element

The `multicast` element includes parameters to fine tune the multicast join mechanism.

- **enabled**: Specifies whether the multicast discovery is enabled or not, `true` or `false`.
- **multicast-group**: The multicast group IP address. Specify it when you want to create clusters within the same network. Values can be between 224.0.0.0 and 239.255.255.255. Its default value is 224.2.2.3.
- **multicast-port**: The multicast socket port that the Hazelcast member listens to and sends discovery messages through. Its default value is 54327.
- **multicast-time-to-live**: Time-to-live value for multicast packets sent out to control the scope of multicasts. See more information [here](#).
- **multicast-timeout-seconds**: Only when the members are starting up, this timeout (in seconds) specifies the period during which a member waits for a multicast response from another member. For example, if you set it as 60 seconds, each member will wait for 60 seconds until a leader member is selected. Its default value is 2 seconds.
- **trusted-interfaces**: Includes IP addresses of trusted members. When a member wants to join to the cluster, its join request will be rejected if it is not a trusted member. You can give an IP addresses range using the wildcard (\*) on the last digit of IP address, e.g., 192.168.1.\* or 192.168.1.100-110.

### tcp-ip element

The `tcp-ip` element includes parameters to fine tune the TCP/IP join mechanism.

- **enabled**: Specifies whether the TCP/IP discovery is enabled or not. Values can be `true` or `false`.
- **required-member**: IP address of the required member. Cluster will only formed if the member with this IP address is found.
- **member**: IP address(es) of one or more well known members. Once members are connected to these well known ones, all member addresses will be communicated with each other. You can also give comma separated IP addresses using the `members` element.



`tcp-ip` element also accepts the `interface` parameter. Please refer to the [Interfaces element description](#).

- **connection-timeout-seconds**: Defines the connection timeout in seconds. This is the maximum amount of time Hazelcast is going to try to connect to a well known member before giving up. Setting it to a too low value could mean that a member is not able to connect to a cluster. Setting it to a too high value means that member startup could slow down because of longer timeouts, for example when a well known member is not up. Increasing this value is recommended if you have many IPs listed and the members cannot properly build up the cluster. Its default value is 5 seconds.

## aws element

The **aws** element includes parameters to allow the members to form a cluster on the Amazon EC2 environment.

- **enabled**: Specifies whether the EC2 discovery is enabled or not, **true** or **false**.
- **access-key**, **secret-key**: Access and secret keys of your account on EC2.
- **region**: The region where your members are running. Its default value is **us-east-1**. You need to specify this if the region is other than the default one.
- **host-header**: The URL that is the entry point for a web service. It is optional.
- **security-group-name**: Name of the security group you specified at the EC2 management console. It is used to narrow the Hazelcast members to be within this group. It is optional.
- **tag-key**, **tag-value**: To narrow the members in the cloud down to only Hazelcast members, you can set these parameters as the ones you specified in the EC2 console. They are optional.
- **connection-timeout-seconds**: The maximum amount of time, in seconds, Hazelcast will try to connect to a well known member before giving up. Setting this value too low could mean that a member is not able to connect to a cluster. Setting the value too high means that member startup could slow down because of longer timeouts (for example, when a well known member is not up). Increasing this value is recommended if you have many IPs listed and the members cannot properly build up the cluster. Its default value is 5 seconds.

If you are using a cloud provider other than AWS, you can use the programmatic configuration to specify a TCP/IP cluster. The members will need to be retrieved from that provider, e.g., jclouds.

## discovery-strategies element

The **discovery-strategies** element configures internal or external discovery strategies based on the Hazelcast Discovery SPI. For further information, please refer to the [Discovery SPI section](#) and the vendor documentation of the used discovery strategy.

### 5.10.6. AWSClient Configuration

To make sure EC2 instances are found correctly, you can use the **AWSClient** class. It determines the private IP addresses of EC2 instances to be connected. Give the **AWSClient** class the values for the parameters that you specified in the **aws** element, as shown below. You will see whether your EC2 instances are found.

```

public static void main( String[] args )throws Exception{
    AwsConfig config = new AwsConfig();
    config.setSecretKey( ... );
    config.setSecretKey( ... );
    config.setRegion( ... );
    config.setSecurityGroupName( ... );
    config.setTagKey( ... );
    config.setTagValue( ... );
    config.setEnabled( true );
    AWSClient client = new AWSClient( config );
    Collection<String> ipAddresses = client.getPrivateIpAddresses();
    System.out.println( "addresses found:" + ipAddresses );
    for ( String ip: ipAddresses ) {
        System.out.println( ip );
    }
}

```

### 5.10.7. Interfaces

You can specify which network interfaces that Hazelcast should use. Servers mostly have more than one network interface, so you may want to list the valid IPs. Range characters ('\*' and '-') can be used for simplicity. For instance, 10.3.10.\* refers to IPs between 10.3.10.0 and 10.3.10.255. Interface 10.3.10.4-18 refers to IPs between 10.3.10.4 and 10.3.10.18 (4 and 18 included). If network interface configuration is enabled (it is disabled by default) and if Hazelcast cannot find a matching interface, then it will print a message on the console and will not start on that member.

The following are example configurations.

#### Declarative:

```

<hazelcast>
...
<network>
...
<interfaces enabled="true">
  <interface>10.3.16.*</interface>
  <interface>10.3.10.4-18</interface>
  <interface>192.168.1.3</interface>
</interfaces>
</network>
...
</hazelcast>

```

#### Programmatic:

```

Config config = new Config();
NetworkConfig network = config.getNetworkConfig();
InterfacesConfig interfaceConfig = network.getInterfaces();
interfaceConfig.setEnabled( true )
    .addInterface( "192.168.1.3" );

```

### 5.10.8. IPv6 Support

Hazelcast supports IPv6 addresses seamlessly (This support is switched off by default, please see the note at the end of this section).

All you need is to define IPv6 addresses or interfaces in the network configuration. The only current limitation is that you cannot define wildcard IPv6 addresses in the TCP/IP join configuration (`tcp-ip` element). `Interfaces` configuration does not have this limitation, you can configure wildcard IPv6 interfaces in the same way as IPv4 interfaces.

```

<hazelcast>
  ...
  <network>
    <port auto-increment="true">5701</port>
    <join>
      <multicast enabled="false">
        <multicast-group>FF02:0:0:0:0:0:1</multicast-group>
        <multicast-port>54327</multicast-port>
      </multicast>
      <tcp-ip enabled="true">
        <member>[fe80::223:6cff:fe93:7c7e]:5701</member>
        <interface>192.168.1.0-7</interface>
        <interface>192.168.1.*</interface>
        <interface>fe80:0:0:0:45c5:47ee:fe15:493a</interface>
      </tcp-ip>
    </join>
    <interfaces enabled="true">
      <interface>10.3.16.*</interface>
      <interface>10.3.10.4-18</interface>
      <interface>fe80:0:0:0:45c5:47ee:fe15:*</interface>
      <interface>fe80::223:6cff:fe93:0-5555</interface>
    </interfaces>
    ...
  </network>
  ...
</hazelcast>

```

JVM has two system properties for setting the preferred protocol stack (IPv4 or IPv6) as well as the preferred address family types (inet4 or inet6). On a dual stack machine, IPv6 stack is preferred by default, you can change this through the `java.net.preferIPv4Stack=<true|false>` system property. When querying name services, JVM prefers IPv4 addresses over IPv6 addresses and will return an IPv4 address if possible. You can change this through `java.net.preferIPv6Addresses=<true|false>`

system property.

Also see additional [details on IPv6 support in Java](#).



IPv6 support has been switched off by default, since some platforms have issues using the IPv6 stack. Some other platforms such as Amazon AWS have no support at all. To enable IPv6 support, just set configuration property `hazelcast.prefer.ipv4.stack` to **false**. Please refer to the [System Properties appendix](#) for details.

### 5.10.9. Member Address Provider SPI



This SPI is not intended to provide addresses of other cluster members with which the Hazelcast instance will form a cluster. To do that, refer to the other network configuration sections above.

By default, Hazelcast chooses the public and bind address. You can influence on the choice by defining a `public-address` in the configuration or by using other properties mentioned above. In some cases, though, these properties are not enough and the default address picking strategy will choose wrong addresses. This may be the case when deploying Hazelcast in some cloud environments, such as AWS, when using Docker or when the instance is deployed behind a NAT and the `public-address` property is not enough (please see the [Public Address section](#)).

In these cases, it is possible to configure the bind and public address in a more advanced way. You can provide an implementation of the `com.hazelcast.spi.MemberAddressProvider` interface which will provide the bind and public address. The implementation may then choose these addresses in any way - it may read from a system property or file or even invoke a web service to retrieve the public and private address.

The details of the implementation depend heavily on the environment in which Hazelcast is deployed. As such, we will demonstrate how to configure Hazelcast to use a simplified custom member address provider SPI implementation. An example of an implementation is shown below:

```
public static final class SimpleMemberAddressProvider implements MemberAddressProvider
{
    @Override
    public InetSocketAddress getBindAddress() {
        // determine the address using some configuration, calling an API, ...
        return new InetSocketAddress(hostname, port);
    }

    @Override
    public InetSocketAddress getPublicAddress() {
        // determine the address using some configuration, calling an API, ...
        return new InetSocketAddress(hostname, port);
    }
}
```

Note that if the bind address port is `0` then it will use a port as configured in the Hazelcast network configuration (see the [Port section](#)). If the public address port is set to `0` then it will broadcast the same port that it is bound to. If you wish to bind to any local interface, you may return `new InetSocketAddress((InetAddress) null, port)` from the `getBindAddress()` address.

The following configuration examples contain properties that will be provided to the constructor of the provided class. If you do not provide any properties, the class may have either a no-arg constructor or a constructor accepting a single `java.util.Properties` instance. On the other hand, if you do provide properties in the configuration, the class must have a constructor accepting a single `java.util.Properties` instance.

#### Declarative:

```
<network>
  <member-address-provider enabled="true">
    <class-name>SimpleMemberAddressProvider</class-name>
    <properties>
      <property name="prop1">prop1-value</property>
      <property name="prop2">prop2-value</property>
    </properties>
  </member-address-provider>
  <!-- other network configuration -->
</network>
```

#### Programmatic:

```
Config config = new Config();
MemberAddressProviderConfig memberAddressProviderConfig = config.getNetworkConfig()
    .getMemberAddressProviderConfig();
memberAddressProviderConfig
    .setEnabled(true)
    .setClassName(MemberAddressProviderWithStaticProperties.class.getName());
Properties properties = memberAddressProviderConfig.getProperties();
properties.setProperty("prop1", "prop1-value");
properties.setProperty("prop2", "prop2-value");

config.getNetworkConfig().getJoin().getMulticastConfig().setEnabled(false);

// perform other configuration

Hazelcast.newHazelcastInstance(config);
```

## 5.11. Failure Detector Configuration

A failure detector is responsible to determine if a member in the cluster is unreachable or crashed. The most important problem in failure detection is to distinguish whether a member is still alive but slow or has crashed. But according to the famous [FLP result](#), it is impossible to distinguish a

crashed member from a slow one in an asynchronous system. A workaround to this limitation is to use unreliable failure detectors. An unreliable failure detector allows a member to suspect that others have failed, usually based on liveness criteria but it can make mistakes to a certain degree.

Hazelcast has two built-in failure detectors; Deadline Failure Detector and Phi Accrual Failure Detector.

Since 3.9.1, Hazelcast provides yet another failure detector, Ping Failure Detector, that, if enabled, works in parallel with the above ones, but identifies failures on OSI Layer 3 (Network Layer). This detector is by default disabled.

Note that, Hazelcast also offers failure detectors for its Java client. Please refer to the [Client Failure Detectors section](#) for more information.

### 5.11.1. Deadline Failure Detector

*Deadline Failure Detector* uses an absolute timeout for missing/lost heartbeats. After timeout, a member is considered as crashed/unavailable and marked as suspected.

*Deadline Failure Detector* has two configuration properties:

- `hazelcast.heartbeat.interval.seconds`: This is the interval at which member heartbeat messages are sent to each other.
- `hazelcast.max.no.heartbeat.seconds`: This is the timeout which defines when a cluster member is suspected because it has not sent any heartbeats.

To use *Deadline Failure Detector* configuration property `hazelcast.heartbeat.failedetector.type` should be set to `"deadline"`.

```
<hazelcast>
  [...]
  <properties>
    <property name="hazelcast.heartbeat.failedetector.type">deadline</property>
    <property name="hazelcast.heartbeat.interval.seconds">5</property>
    <property name="hazelcast.max.no.heartbeat.seconds">120</property>
    [...]
  </properties>
  [...]
</hazelcast>
```

```
Config config = ...;
config.setProperty("hazelcast.heartbeat.failedetector.type", "deadline");
config.setProperty("hazelcast.heartbeat.interval.seconds", "5");
config.setProperty("hazelcast.max.no.heartbeat.seconds", "120");
[...]
```



*Deadline Failure Detector* is the default failure detector in Hazelcast.



## 5.11.2. Phi Accrual Failure Detector

This is the failure detector based on [The Phi Accrual Failure Detector](#) by Hayashibara et al.

Phi Accrual Failure Detector keeps track of the intervals between heartbeats in a sliding window of time and measures the mean and variance of these samples and calculates a value of suspicion level (Phi). The value of phi will increase when the period since the last heartbeat gets longer. If the network becomes slow or unreliable, the resulting mean and variance will increase, there will need to be a longer period for which no heartbeat is received before the member is suspected.

`hazelcast.heartbeat.interval.seconds` and `hazelcast.max.no.heartbeat.seconds` properties will still be used as period of heartbeat messages and deadline of heartbeat messages. Since *Phi Accrual Failure Detector* is adaptive to network conditions, a much lower `hazelcast.max.no.heartbeat.seconds` can be defined than *Deadline Failure Detector*'s timeout.

Additional to above two properties, *Phi Accrual Failure Detector* has three more configuration properties:

- `hazelcast.heartbeat.phiaccrual.failedetector.threshold`: This is the phi threshold for suspicion. After calculated phi exceeds this threshold, a member is considered as unreachable and marked as suspected. A low threshold allows to detect member crashes/failures faster but can generate more mistakes and cause wrong member suspicions. A high threshold generates fewer mistakes but is slower to detect actual crashes/failures.

`phi = 1` means likeliness that we will make a mistake is about **10%**. The likeliness is about **1%** with `phi = 2`, **0.1%** with `phi = 3` and so on. Default phi threshold is 10.

- `hazelcast.heartbeat.phiaccrual.failedetector.sample.size`: Number of samples to keep for history. Its default value is 200.
- `hazelcast.heartbeat.phiaccrual.failedetector.min.std.dev.millis`: Minimum standard deviation to use for the normal distribution used when calculating phi. Too low standard deviation might result in too much sensitivity.

To use *Phi Accrual Failure Detector*, configuration property `hazelcast.heartbeat.failedetector.type` should be set to `"phi-accrual"`.

```

<hazelcast>
  [...]
  <properties>
    <property name="hazelcast.heartbeat.faileddetector.type">phi-accrual</property>
    <property name="hazelcast.heartbeat.interval.seconds">1</property>
    <property name="hazelcast.max.no.heartbeat.seconds">60</property>
    <property name="hazelcast.heartbeat.phiaccrual.faileddetector.threshold">10<
/property>
    <property name="hazelcast.heartbeat.phiaccrual.faileddetector.sample.size">200
</property>
    <property name=
"hazelcast.heartbeat.phiaccrual.faileddetector.min.std.dev.millis">100</property>
    [...]
  </properties>
  [...]
</hazelcast>

```

```

Config config = ...;
config.setProperty("hazelcast.heartbeat.faileddetector.type", "phi-accrual");
config.setProperty("hazelcast.heartbeat.interval.seconds", "1");
config.setProperty("hazelcast.max.no.heartbeat.seconds", "60");
config.setProperty("hazelcast.heartbeat.phiaccrual.faileddetector.threshold", "10");
config.setProperty("hazelcast.heartbeat.phiaccrual.faileddetector.sample.size", "200
");
config.setProperty("hazelcast.heartbeat.phiaccrual.faileddetector.min.std.dev.millis"
, "100");
[...]

```

### 5.11.3. Ping Failure Detector

The Ping Failure Detector may be configured in addition to one of Deadline and Phi Accrual Failure Detectors. It operates at Layer 3 of the OSI protocol and provides much quicker and more deterministic detection of hardware and other lower level events. This detector may be configured to perform an extra check after a member is suspected by one of the other detectors, or it can work in parallel, which is the default. This way hardware and network level issues will be detected more quickly.

This failure detector is based on `InetAddress.isReachable()`. When the JVM process has enough permissions to create RAW sockets, the implementation will choose to rely on ICMP Echo requests. This is preferred.

If there are not enough permissions, it can be configured to fallback on attempting a TCP Echo on port 7. In the latter case, both a successful connection or an explicit rejection will be treated as "Host is Reachable". Or, it can be forced to use only RAW sockets. This is not preferred as each call creates a heavy weight socket and moreover the Echo service is typically disabled.

For the Ping Failure Detector to rely **only** on ICMP Echo requests, there are some criteria that need to be met.

## Requirements and Linux/Unix Configuration

- **Supported OS: as of Java 1.8 only Linux/Unix environments are supported.** This detector relies on ICMP, i.e., the protocol behind the `ping` command. It tries to issue the ping attempts periodically, and their responses are used to determine the reachability of the remote member. However, you cannot simply create an ICMP Echo Request because these type of packets do not rely on any of the preexisting transport protocols such as TCP. In order to create such a request, you must have the privileges to create RAW sockets (please see <https://linux.die.net/man/7/raw>). Most operating systems allow this to the root users, however Unix based ones are more flexible and allow the use of custom privileges per process instead of requiring root access. Therefore, this detector is supported only on Linux.
- **The Java executable must have the `cap_net_raw` capability.** As described in the above requirement, on Linux, you have the ability to define extra capabilities to a single process, which would allow the process to interact with the RAW sockets. This interaction is achieved via the capability `cap_net_raw` (please see <https://linux.die.net/man/7/capabilities>). To enable this capability run the following command:

```
sudo setcap cap_net_raw=+ep <JDK_HOME>/jre/bin/java
```

- **When running with custom capabilities, the dynamic linker on Linux will reject loading libs from untrusted paths.** Since you have now `cap_net_raw` as a custom capability for a process, it becomes suspicious to the dynamic linker and it will throw an error: `java: error while loading shared libraries: libjli.so: cannot open shared object file: No such file or directory`
  - To overcome this rejection, the `<JDK_HOME>/jre/lib/amd64/jli/` path needs to be added in the `ld.conf`. Run the following command to do this: `echo "<JDK_HOME>/jre/lib/amd64/jli/" >> /etc/ld.so.conf.d/java.conf && sudo ldconfig`
- **ICMP Echo Requests must not be blocked by the receiving hosts.** `/proc/sys/net/ipv4/icmp_echo_ignore_all` set to `0`. Run the following command:

```
echo 0 > /proc/sys/net/ipv4/icmp_echo_ignore_all
```

If any of the above criteria isn't met, then the `isReachable` will always fallback on TCP Echo attempts on port 7.

To be able to use the Ping Failure Detector, please add the following properties in your Hazelcast declarative configuration file:

```

<hazelcast>
  [...]
  <properties>
    <property name="hazelcast.icmp.enabled">true</property>
    <property name="hazelcast.icmp.parallel.mode">true</property>
    <property name="hazelcast.icmp.timeout">1000</property>
    <property name="hazelcast.icmp.max.attempts">3</property>
    <property name="hazelcast.icmp.interval">1000</property>
    <property name="hazelcast.icmp.ttl">0</property>
    [...]
  </properties>
  [...]
</hazelcast>

```

- `hazelcast.icmp.enabled` (default false) - Enables legacy ICMP detection mode, works cooperatively with the existing failure detector and only kicks-in after a pre-defined period has passed with no heartbeats from a member.
- `hazelcast.icmp.parallel.mode` (default true) - Enabling the parallel ping detector, works separately from the other detectors.
- `hazelcast.icmp.timeout` (default 1000) - Number of milliseconds until a ping attempt is considered failed if there was no reply.
- `hazelcast.icmp.max.attempts` (default 3) - The maximum number of ping attempts before the member/node gets suspected by the detector.
- `hazelcast.icmp.interval` (default 1000) - The interval, in milliseconds, between each ping attempt. 1000ms (1 sec) is also the minimum interval allowed.
- `hazelcast.icmp.ttl` (default 0) - The maximum number of hops the packets should go through or 0 for the default.

In the above configuration, the Ping detector will attempt 3 pings, one every second and will wait up-to 1 second for each to complete. If after 3 seconds, there was no successful ping, the member will get suspected.

To enforce the [Requirements](#), the property `hazelcast.icmp.echo.fail.fast.on.startup` can also be set to `true`, in which case, if any of the requirements isn't met, Hazelcast will fail to start.

Below is a summary table of all possible configuration combinations of the ping failure detector.

*Table 3. Ping Failure Detector Possible Configuration Combinations*

ICMP	Parallel	Fail-Fast	Description	Linux	Windows	macOS
false	false	false	Completely disabled	N/A	N/A	N/A

ICMP	Parallel	Fail-Fast	Description	Linux	Windows	macOS
true	false	false	Legacy ping mode. This works hand-to-hand with the OSI Layer 7 failure detector (see. phi or deadline in sections above). Ping in this mode will only kick in after a period when there are no heartbeats received, in which case the remote Hazelcast member is pinged up to a configurable count of attempts. If all those attempts fail, the member gets suspected. You can configure this attempt count using the <a href="#">hazelcast.icmp.max.attempts</a> system property.	Supported ICMP Echo if available - Falls back on TCP Echo on port 7	Supported TCP Echo on port 7	Supported ICMP Echo if available - Falls back on TCP Echo on port 7
true	true	false	Parallel ping detector, works in parallel with the configured failure detector. Checks periodically if members are live (OSI Layer 3) and suspects them immediately, regardless of the other detectors.	Supported ICMP Echo if available - Falls back on TCP Echo on port 7	Supported TCP Echo on port 7	Supported ICMP Echo if available - Falls back on TCP Echo on port 7
true	true	true	Parallel ping detector, works in parallel with the configured failure detector. Checks periodically if members are live (OSI Layer 3) and suspects them immediately, regardless of the other detectors.	Supported - Requires OS Configuration Enforcing ICMP Echo if available - No start up if not available	Not Supported	Not Supported - Requires root privileges

## 6. Rolling Member Upgrades

### Hazelcast IMDG Enterprise

This chapter explains the procedure of upgrading the version of Hazelcast members in a running cluster without interrupting the operation of the cluster.

### 6.1. Terminology

- **Minor version:** A version change after the decimal point, e.g., 3.10 and 3.11.

- **Patch version:** A version change after the second decimal point, e.g., 3.10.1 and 3.10.2.
- **Member codebase version:** The `major.minor.patch` version of the Hazelcast binary on which the member executes. For example, when running on `hazelcast-3.10.jar`, your member's codebase version is `3.10.0`.
- **Cluster version:** The `major.minor` version at which the cluster operates. This ensures that cluster members are able to communicate using the same cluster protocol and determines the feature set exposed by the cluster.

## 6.2. Hazelcast Members Compatibility Guarantees

Hazelcast members operating on binaries of the same major and minor version numbers are compatible regardless of patch version. For example, in a cluster with members running on version 3.10.1, it is possible to perform a rolling upgrade to 3.10.2 by shutting down, upgrading to `hazelcast-3.10.2.jar` binary and starting each member one by one. *Patch level compatibility applies to both Hazelcast IMDG and Hazelcast IMDG Enterprise.*

Each next minor version released is compatible with the previous one. For example, it will be possible to perform a rolling upgrade on a cluster running Hazelcast IMDG Enterprise 3.10 to Hazelcast IMDG Enterprise 3.11 whenever that is released. *Rolling upgrades across minor versions is a Hazelcast IMDG Enterprise feature, starting with version 3.8.*

The compatibility guarantees described above are given in the context of rolling member upgrades and only apply to GA (general availability) releases. It is never advisable to run a cluster with members running on different patch or minor versions for prolonged periods of time.

## 6.3. Rolling Upgrade Procedure



The version numbers used in the paragraph below are only used as an example.

Let's assume a cluster with four members running on codebase version `3.10.0` with cluster version `3.10`, that should be upgraded to codebase version `3.11.0` and cluster version `3.11`. The rolling upgrade process for this cluster, i.e., replacing existing `3.10.0` members one by one with an upgraded one at version `3.11.0`, includes the following steps which should be repeated for each member:

- Shutdown gracefully an existing `3.10.0` member.
- Wait until all partition migrations are completed; during migrations, membership changes (member joins or removals) are not allowed.
- Update the member with the new `3.11.0` Hazelcast binaries.
- Start the member and wait until it joins the cluster. You should see something like the following in your logs:

```
...
INFO: [192.168.2.2]:5701 [cluster] [3.11] Hazelcast 3.11 (20170630 - a67dc3a)
starting at [192.168.2.2]:5701
...
INFO: [192.168.2.2]:5701 [cluster] [3.11] Cluster version set to 3.10
```

The version in brackets `[3.11]` still denotes the member's codebase version (running on the hypothetical `hazelcast-3.11.jar` binary). Once the member locates existing cluster members, it sends its join request to the master. The master validates that the new member is allowed to join the cluster and lets the new member know that the cluster is currently operating at `3.10` cluster version. The new member sets `3.10` as its cluster version and starts operating normally.

At this point all members of the cluster have been upgraded to codebase version `3.11.0` but the cluster still operates at cluster version `3.10`. In order to use `3.11` features the cluster version must be changed to `3.11`. There are two ways to accomplish this:

- Use [Management Center](#).
- Use the command line [cluster.sh script](#).



You need to enable the REST API to use either of the above methods to upgrade your cluster version. For this, set the `hazelcast.rest.enabled` system property to `true` (its default is `false`).



You need to upgrade your Management Center version **before** upgrading the member version if you want to change cluster version using Management Center. Management Center is compatible with the previous minor version of Hazelcast, starting with version 3.9. For example, Management Center 3.11 works with both Hazelcast IMDG 3.10 and 3.11. To change your cluster version to 3.11, you need Management Center 3.11.

## 6.4. Network Partitions and Rolling Upgrades

In the event of network partitions which split your cluster into two subclusters, split-brain handling works as explained in the [Network Partitioning chapter](#), with the additional constraint that two subclusters will only merge as long as they operate on the same cluster version. This is a requirement to ensure that all members participating in each one of the subclusters will be able to operate as members of the merged cluster at the same cluster version.

With regards to rolling upgrades, the above constraint implies that if a network partition occurs while a change of cluster version is in progress, then with some unlucky timing, one subcluster may be upgraded to the new cluster version and another subcluster may have upgraded members but still operate at the old cluster version.

In order for the two subclusters to merge, it is necessary to change the cluster version of the subcluster that still operates at the old cluster version, so that both subclusters will be operating at the same, upgraded cluster version and will be able to merge as soon as the network partition is

fixed.

## 6.5. Rolling Upgrade FAQ

The following provide answers to the frequently asked questions related to rolling member upgrades.

### How is the cluster version set?

When a new member starts, it is not yet joined to a cluster; therefore its cluster version is still undetermined. In order for the cluster version to be set, one of the following must happen:

- the member cannot locate any members of the cluster to join or is configured without a joiner: in this case, the member will appoint itself as the master of a new single-member cluster and its cluster version will be set to the `major.minor` version of its own codebase version. So a standalone member running on codebase version `3.10.0` will set its own cluster version to `3.10`.
- the member that is starting locates members of the cluster and identifies which is the master: in this case, the master will validate that the joining member's codebase version is compatible with the current cluster version. If it is found to be compatible, then the member joins and the master sends the cluster version, which is set on the joining member. Otherwise, the starting member fails to join and shuts down.

### What if a new Hazelcast minor version changes fundamental cluster protocol communication, like join messages?



The version numbers used in the paragraph below are only used as an example.

On startup, as answered in the above question (How is the cluster version set?), the cluster version is not yet known to a member that has not joined any cluster. By default the newly started member will use the cluster protocol that corresponds to its codebase version until this member joins a cluster (so for codebase `3.11.0` this means implicitly assuming cluster version `3.11`). If, hypothetically, major changes in discovery & join operations have been introduced which do not allow the member to join a `3.10` cluster, then the member should be explicitly configured to start assuming a `3.10` cluster version.

### Do I have to upgrade clients to work with rolling upgrades?

Starting with Hazelcast 3.6, the Hazelcast Open Binary Client Protocol was introduced. Clients which implement the Open Binary Client Protocol are compatible with Hazelcast version 3.6 and newer minor versions. Thus older client versions will be compatible with next minor versions. Newer clients connected to a cluster will operate at the lower version of capabilities until all members are upgraded and the cluster version upgrade occurs.

### Can I stop and start multiple members at once during a rolling member upgrade?

It is not recommended due to potential network partitions. It is advised to always stop and start one member in each upgrade step.

### Can I upgrade my business app together with Hazelcast while doing a rolling member



## upgrade?

Yes, but make sure to make the new version of your app compatible with the old one since there will be a timespan when both versions interoperate. Checking if two versions of your app are compatible includes verifying binary and algorithmic compatibility and some other steps.

It is worth mentioning that a business app upgrade is orthogonal to a rolling member upgrade. A rolling business app upgrade may be done without upgrading the members.

# 7. Distributed Data Structures

As mentioned in the [Overview section](#), Hazelcast offers distributed implementations of Java interfaces. Below is the list of these implementations with links to the corresponding sections in this manual.

### • Standard utility collections

- [Map](#) is the distributed implementation of `java.util.Map`. It lets you read from and write to a Hazelcast map with methods such as `get` and `put`.
- [Queue](#) is the distributed implementation of `java.util.concurrent.BlockingQueue`. You can add an item in one member and remove it from another one.
- [Ringbuffer](#) is implemented for reliable eventing system.
- [Set](#) is the distributed and concurrent implementation of `java.util.Set`. It does not allow duplicate elements and does not preserve their order.
- [List](#) is similar to Hazelcast Set. The only difference is that it allows duplicate elements and preserves their order.
- [Multimap](#) is a specialized Hazelcast map. It is a distributed data structure where you can store multiple values for a single key.
- [Replicated Map](#) does not partition data. It does not spread data to different cluster members. Instead, it replicates the data to all members.
- [Cardinality Estimator](#) is a data structure which implements Flajolet's HyperLogLog algorithm.

- **Topic** is the distributed mechanism for publishing messages that are delivered to multiple subscribers. It is also known as the publish/subscribe (pub/sub) messaging model. Please see the [Topic section](#) for more information. Hazelcast also has a structure called Reliable Topic which uses the same interface of Hazelcast Topic. The difference is that it is backed up by the Ringbuffer data structure. Please see the [Reliable Topic section](#).

### • Concurrency utilities

- [Lock](#) is the distributed implementation of `java.util.concurrent.locks.Lock`. When you use lock, the critical section that Hazelcast Lock guards is guaranteed to be executed by only one thread in the entire cluster.
- [ISemaphore](#) is the distributed implementation of `java.util.concurrent.Semaphore`. When performing concurrent activities, semaphores offer permits to control the thread counts.
- [IAAtomicLong](#) is the distributed implementation of `java.util.concurrent.atomic.AtomicLong`.

Most of AtomicLong's operations are available. However, these operations involve remote calls and hence their performances differ from AtomicLong, due to being distributed.

- [IAAtomicReference](#) is the distributed implementation of `java.util.concurrent.atomic.AtomicReference`. When you need to deal with a reference in a distributed environment, you can use Hazelcast IAAtomicReference.
- [IdGenerator](#) is used to generate cluster-wide unique identifiers. ID generation occurs almost at the speed of `AtomicLong.incrementAndGet()`. This feature is deprecated, please use [FlakeIdGenerator](#) instead.
- [ICountDownLatch](#) is the distributed implementation of `java.util.concurrent.CountDownLatch`. Hazelcast CountDownLatch is a gate keeper for concurrent activities. It enables the threads to wait for other threads to complete their operations.
- [PN counter](#) is a distributed data structure where each Hazelcast instance can increment and decrement the counter value and these updates are propagated to all replicas.
- [Event Journal](#) is a distributed data structure that stores the history of mutation actions on map or cache.

## 7.1. Overview of Hazelcast Distributed Objects

Hazelcast has two types of distributed objects in terms of their partitioning strategies:

1. Data structures where each partition stores a part of the instance, namely partitioned data structures.
2. Data structures where a single partition stores the whole instance, namely non-partitioned data structures.

Partitioned Hazelcast data structures are:

- Map
- MultiMap
- Cache (Hazelcast JCache implementation)
- PN Counter
- Event Journal

Non-partitioned Hazelcast data structures are:

- Queue
- Set
- List
- Ringbuffer
- Lock
- ISemaphore
- IAtomicLong

- IAtomicReference
- FlakeIdGenerator
- ICountdownLatch
- Cardinality Estimator

Besides these, Hazelcast also offers the Replicated Map structure as explained in the above **Standard utility collections** list.

### 7.1.1. Loading and Destroying a Distributed Object

Hazelcast offers a `get` method for most of its distributed objects. To load an object, first create a Hazelcast instance and then use the related `get` method on this instance. Following example code snippet creates an Hazelcast instance and a map on this instance.

```
HazelcastInstance hazelcastInstance = Hazelcast.newHazelcastInstance();
Map<Integer, String> customers = hazelcastInstance.getMap( "customers" );
```

As to the configuration of distributed object, Hazelcast uses the default settings from the file `hazelcast.xml` that comes with your Hazelcast download. Of course, you can provide an explicit configuration in this XML or programmatically according to your needs. Please see the [Understanding Configuration section](#).

Note that, most of Hazelcast's distributed objects are created lazily, i.e., a distributed object is created once the first operation accesses it.

If you want to use an object you loaded in other places, you can safely reload it using its reference without creating a new Hazelcast instance (`customers` in the above example).

To destroy a Hazelcast distributed object, you can use the method `destroy`. This method clears and releases all resources of the object. Therefore, you must use it with care since a reload with the same object reference after the object is destroyed creates a new data structure without an error. Please see the following example code where one of the queues are destroyed and the other one is accessed.

```
HazelcastInstance hz1 = Hazelcast.newHazelcastInstance();
HazelcastInstance hz2 = Hazelcast.newHazelcastInstance();
IQueue<String> q1 = hz1.getQueue("q");
IQueue<String> q2 = hz2.getQueue("q");
q1.add("foo");
System.out.println("q1.size: "+q1.size()+ " q2.size:"+q2.size());
q1.destroy();
System.out.println("q1.size: " + q1.size() + " q2.size:" + q2.size());
```

If you start the `Member` above, the output will be as shown below:

```
q1.size: 1 q2.size:1  
q1.size: 0 q2.size:0
```

As you see, no error is generated and a new queue resource is created.

### 7.1.2. Controlling Partitions

Hazelcast uses the name of a distributed object to determine which partition it will be put. Let's load two semaphores as shown below:

```
HazelcastInstance hazelcastInstance = Hazelcast.newHazelcastInstance();  
ISemaphore s1 = hazelcastInstance.getSemaphore("s1");  
ISemaphore s2 = hazelcastInstance.getSemaphore("s2");
```

Since these semaphores have different names, they will be placed into different partitions. If you want to put these two into the same partition, you use the @ symbol as shown below:

```
HazelcastInstance hazelcastInstance = Hazelcast.newHazelcastInstance();  
ISemaphore s1 = hazelcastInstance.getSemaphore("s1@foo");  
ISemaphore s2 = hazelcastInstance.getSemaphore("s2@foo");
```

Now, these two semaphores will be put into the same partition whose partition key is `foo`. Note that you can use the method `getPartitionKey` to learn the partition key of a distributed object. It may be useful when you want to create an object in the same partition of an existing object. Please see its usage as shown below:

```
String partitionKey = s1.getPartitionKey();  
ISemaphore s3 = hazelcastInstance.getSemaphore("s3@"+partitionKey);
```

### 7.1.3. Common Features of all Hazelcast Data Structures

- If a member goes down, its backup replica (which holds the same data) will dynamically redistribute the data, including the ownership and locks on them, to the remaining live members. As a result, there will not be any data loss.
- There is no single cluster master that can be a single point of failure. Every member in the cluster has equal rights and responsibilities. No single member is superior. There is no dependency on an external 'server' or 'master'.

### 7.1.4. Example Distributed Object Code

Here is an example of how you can retrieve existing data structure instances (map, queue, set, lock, topic, etc.) and how you can listen for instance events, such as an instance being created or destroyed.

```

SampleDOL sample = new SampleDOL();
Config config = new Config();

HazelcastInstance hazelcastInstance = Hazelcast.newHazelcastInstance(config);
hazelcastInstance.addDistributedObjectListener(sample);

Collection<DistributedObject> distributedObjects = hazelcastInstance
.get DistributedObjects();
for (DistributedObject distributedObject : distributedObjects) {
    System.out.println(distributedObject.getName());
}
}

@Override
public void distributedObjectCreated(DistributedObjectEvent event) {
    DistributedObject instance = event.getDistributedObject();
    System.out.println("Created " + instance.getName());
}

@Override
public void distributedObjectDestroyed(DistributedObjectEvent event) {
    DistributedObject instance = event.getDistributedObject();
    System.out.println("Destroyed " + instance.getName());
}

```

## 7.2. Map

Hazelcast Map (`IMap`) extends the interface `java.util.concurrent.ConcurrentMap` and hence `java.util.Map`. It is the distributed implementation of Java map. You can perform operations like reading and writing from/to a Hazelcast map with the well known get and put methods.



`IMap` data structure can also be used by [Hazelcast Jet](#) for Real-Time Stream Processing (by enabling the Event Journal on your map) and Fast Batch Processing. Hazelcast Jet uses `IMap` as a source (reads data from `IMap`) and as a sink (writes data to `IMap`). Please see the [Fast Batch Processing](#) and [Real-Time Stream Processing](#) use cases for Hazelcast Jet. Please also see [here](#) in the Hazelcast Jet Reference Manual to learn how Jet uses `IMap`, i.e., how it can read from and write to `IMap`.

### 7.2.1. Getting a Map and Putting an Entry

Hazelcast will partition your map entries and their backups, and almost evenly distribute them onto all Hazelcast members. Each member carries approximately "number of map entries \* 2 \* 1/n" entries, where **n** is the number of members in the cluster. For example, if you have a member with 1000 objects to be stored in the cluster and then you start a second member, each member will both store 500 objects and back up the 500 objects in the other member.

Let's create a Hazelcast instance and fill a map named `Capitals` with key-value pairs using the following code. Use the HazelcastInstance `getMap` method to get the map, then use the map `put` method to put an entry into the map.

```
HazelcastInstance hzInstance = Hazelcast.newHazelcastInstance();
Map<String, String> capitalcities = hzInstance.getMap( "capitals" );
capitalcities.put( "1", "Tokyo" );
capitalcities.put( "2", "Paris" );
capitalcities.put( "3", "Washington" );
capitalcities.put( "4", "Ankara" );
capitalcities.put( "5", "Brussels" );
capitalcities.put( "6", "Amsterdam" );
capitalcities.put( "7", "New Delhi" );
capitalcities.put( "8", "London" );
capitalcities.put( "9", "Berlin" );
capitalcities.put( "10", "Oslo" );
capitalcities.put( "11", "Moscow" );
...
capitalcities.put( "120", "Stockholm" );
```

When you run this code, a cluster member is created with a map whose entries are distributed across the members' partitions. See the below illustration. For now, this is a single member cluster.



Please note that some of the partitions will not contain any data entries since we only have 120 objects and the partition count is 271 by default. This count is configurable and can be changed using the system property `hazelcast.partition.count`. Please see the [System Properties appendix](#).

## 7.2.2. Creating A Member for Map Backup

Now let's create a second member by running the above code again. This will create a cluster with two members. This is also where backups of entries are created - remember the backup partitions mentioned in the [Hazelcast Overview](#) section. The following illustration shows two members and how the data and its backup is distributed.

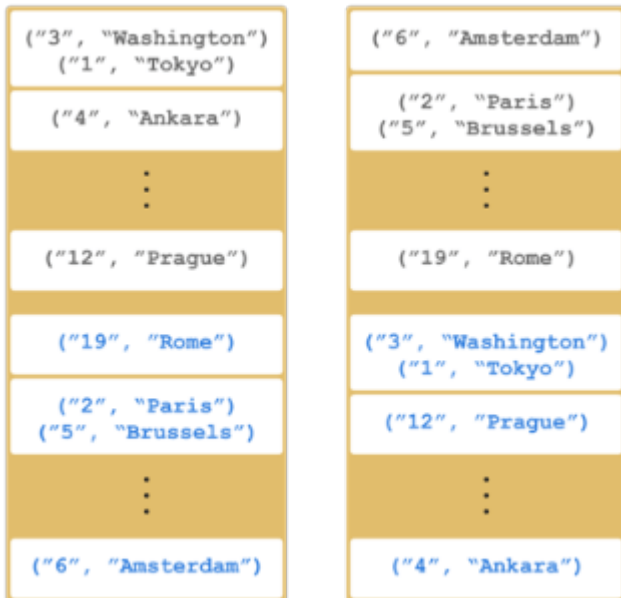

As you see, when a new member joins the cluster, it takes ownership and loads some of the data in the cluster. Eventually, it will carry almost  $(1/n * \text{total-data}) + \text{backups}$  of the data, reducing the load on other members.

`HazelcastInstance.getMap()` returns an instance of `com.hazelcast.core.IMap` which extends the `java.util.concurrent.ConcurrentMap` interface. Methods like `ConcurrentMap.putIfAbsent(key, value)` and `ConcurrentMap.replace(key, value)` can be used on the distributed map, as shown in the example below.

```

public class BasicMapOperations {

    private HazelcastInstance hazelcastInstance = Hazelcast.newHazelcastInstance();

    public Customer getCustomer(String id) {
        ConcurrentMap<String, Customer> customers = hazelcastInstance.getMap(
"customers");
        Customer customer = customers.get(id);
        if (customer == null) {
            customer = new Customer(id);
            customer = customers.putIfAbsent(id, customer);
        }
        return customer;
    }

    public boolean updateCustomer(Customer customer) {
        ConcurrentMap<String, Customer> customers = hazelcastInstance.getMap(
"customers");
        return (customers.replace(customer.getId(), customer) != null);
    }

    public boolean removeCustomer(Customer customer) {
        ConcurrentMap<String, Customer> customers = hazelcastInstance.getMap(
"customers");
        return customers.remove(customer.getId(), customer);
    }
}

```

All `ConcurrentMap` operations such as `put` and `remove` might wait if the key is locked by another thread in the local or remote JVM. But, they will eventually return with success. `ConcurrentMap` operations never throw a `java.util.ConcurrentModificationException`.

Also see:

- [Data Affinity section](#).
- [Map Configuration with wildcards](#).

### 7.2.3. Backing Up Maps

Hazelcast distributes map entries onto multiple cluster members (JVMs). Each member holds some portion of the data.

Distributed maps have one backup by default. If a member goes down, your data is recovered using the backups in the cluster. There are two types of backups as described below: *sync* and *async*.

#### Creating Sync Backups

To provide data safety, Hazelcast allows you to specify the number of backup copies you want to have. That way, data on a cluster member will be copied onto other member(s).



To create synchronous backups, select the number of backup copies using the `backup-count` property.

```
<hazelcast>
  <map name="default">
    <backup-count>1</backup-count>
  </map>
</hazelcast>
```

When this count is 1, a map entry will have its backup on one other member in the cluster. If you set it to 2, then a map entry will have its backup on two other members. You can set it to 0 if you do not want your entries to be backed up, e.g., if performance is more important than backing up. The maximum value for the backup count is 6.

Hazelcast supports both synchronous and asynchronous backups. By default, backup operations are synchronous and configured with `backup-count`. In this case, backup operations block operations until backups are successfully copied to backup members (or deleted from backup members in case of remove) and acknowledgements are received. Therefore, backups are updated before a `put` operation is completed, provided that the cluster is stable. Sync backup operations have a blocking cost which may lead to latency issues.

### Creating Async Backups

Asynchronous backups, on the other hand, do not block operations. They are fire & forget and do not require acknowledgements; the backup operations are performed at some point in time.

To create asynchronous backups, select the number of async backups with the `async-backup-count` property. An example is shown below.

```
<hazelcast>
  <map name="default">
    <backup-count>0</backup-count>
    <async-backup-count>1</async-backup-count>
  </map>
</hazelcast>
```

See [Consistency and Replication Model](#) for more detail.



Backups increase memory usage since they are also kept in memory.



A map can have both sync and async backups at the same time.

### Enabling Backup Reads

By default, Hazelcast has one sync backup copy. If `backup-count` is set to more than 1, then each member will carry both owned entries and backup copies of other members. So for the `map.get(key)` call, it is possible that the calling member has a backup copy of that key. By default,

`map.get(key)` will always read the value from the actual owner of the key for consistency.

To enable backup reads (read local backup entries), set the value of the `read-backup-data` property to **true**. Its default value is **false** for consistency. Enabling backup reads can improve performance but on the other hand it can cause stale reads while still preserving monotonic-reads property.

```
<hazelcast>
  <map name="default">
    <backup-count>0</backup-count>
    <async-backup-count>1</async-backup-count>
    <read-backup-data>true</read-backup-data>
  </map>
</hazelcast>
```

This feature is available when there is at least one sync or async backup.

Please note that if you are performing a read from a backup, you should take into account that your hits to the keys in the backups are not reflected as hits to the original keys on the primary members. This has an impact on IMap's maximum idle seconds or time-to-live seconds expiration. Therefore, even though there is a hit on a key in backups, your original key on the primary member may expire.

## 7.2.4. Map Eviction



Starting with Hazelcast 3.7, Hazelcast Map uses a new eviction mechanism which is based on the sampling of entries. Please see the [Eviction Algorithm section](#) for details.

Unless you delete the map entries manually or use an eviction policy, they will remain in the map. Hazelcast supports policy-based eviction for distributed maps. Currently supported policies are LRU (Least Recently Used) and LFU (Least Frequently Used).

### Understanding Map Eviction

Hazelcast Map performs eviction based on partitions. For example, when you specify a size using the `PER_NODE` attribute for `max-size` (please see [Configuring Map Eviction](#)), Hazelcast internally calculates the maximum size for every partition. Hazelcast uses the following equation to calculate the maximum size of a partition:

$$\text{partition-maximum-size} = \text{max-size} * \text{member-count} / \text{partition-count}$$

If the `partition-maximum-size` is less than 1 in the equation above, it will be set to 1 (otherwise, the partitions would be emptied immediately by eviction due to the exceedance of `max-size` being less than 1).

The eviction process starts according to this calculated partition maximum size when you try to put an entry. When entry count in that partition exceeds partition maximum size, eviction starts on

that partition.

Assume that you have the following figures as examples:

- Partition count: 200
- Entry count for each partition: 100
- `max-size` (PER\_NODE): 20000

The total number of entries here is 20000 (partition count \* entry count for each partition). This means you are at the eviction threshold since you set the `max-size` to 20000. When you try to put an entry

1. the entry goes to the relevant partition;
2. the partition checks whether the eviction threshold is reached (`max-size`);
3. only one entry will be evicted.

As a result of this eviction process, when you check the size of your map, it is 19999. After this eviction, subsequent put operations will not trigger the next eviction until the map size is again close to the `max-size`.



The above scenario is simply an example that describes how the eviction process works. Hazelcast finds the most optimum number of entries to be evicted according to your cluster size and selected policy.

## Configuring Map Eviction

The following is an example declarative configuration for map eviction.

```
<hazelcast>
  <map name="default">
    ...
    <time-to-live-seconds>0</time-to-live-seconds>
    <max-idle-seconds>0</max-idle-seconds>
    <eviction-policy>LRU</eviction-policy>
    <max-size policy="PER_NODE">5000</max-size>
    ...
  </map>
</hazelcast>
```

Let's describe each element:

- `time-to-live-seconds`: Maximum time in seconds for each entry to stay in the map (TTL). It limits the lifetime of the entries relative to the time of the last write access performed on them. If it is not 0, the entries whose lifetime exceeds this period (without any write access performed on them during this period) are expired and evicted automatically. An individual entry may have its own lifetime limit by using one of the methods accepting a TTL; see [Evicting Specific Entries section](#). If there is no TTL value provided for the individual entry, it inherits the value

set for this element. Valid values are integers between 0 and `Integer.MAX VALUE`. Its default value is 0, which means infinite (no expiration and eviction). If it is not 0, entries are evicted regardless of the set `eviction-policy` described below.

- `max-idle-seconds`: Maximum time in seconds for each entry to stay idle in the map. It limits the lifetime of the entries relative to the time of the last read or write access performed on them. The entries whose idle period exceeds this limit are expired and evicted automatically. An entry is idle if no `get`, `put`, `EntryProcessor.process` or `containsKey` is called on it. Valid values are integers between 0 and `Integer.MAX VALUE`. Its default value is 0, which means infinite.



Both `time-to-live-seconds` and `max-idle-seconds` may be used simultaneously on the map entries. In that case, the entry is considered expired if at least one of the policies marks it as expired.

- `eviction-policy`: Eviction policy to be applied when the size of map grows larger than the value specified by the `max-size` element described below. Valid values are:
  - `NONE`: Default policy. If set, no items will be evicted and the property `max-size` described below will be ignored. You still can combine it with `time-to-live-seconds` and `max-idle-seconds`.
  - `LRU`: Least Recently Used.
  - `LFU`: Least Frequently Used.

Apart from the above values, you can also develop and use your own eviction policy. Please see the [Custom Eviction Policy section](#).

- `max-size`: Maximum size of the map. When maximum size is reached, the map is evicted based on the policy defined. Valid values are integers between 0 and `Integer.MAX VALUE`. Its default value is 0, which means infinite. If you want `max-size` to work, set the `eviction-policy` property to a value other than `NONE`. Its attributes are described below.
  - `PER_NODE`: Maximum number of map entries in each cluster member. This is the default policy.

```
<max-size policy="PER_NODE">5000</max-size>
```

- `PER_PARTITION`: Maximum number of map entries within each partition. Storage size depends on the partition count in a cluster member. This attribute should not be used often. For instance, avoid using this attribute with a small cluster. If the cluster is small, it will be hosting more partitions, and therefore map entries, than that of a larger cluster. Thus, for a small cluster, eviction of the entries will decrease performance (the number of entries is large).

```
<max-size policy="PER_PARTITION">27100</max-size>
```

- `USED_HEAP_SIZE`: Maximum used heap size in megabytes per map for each Hazelcast instance. Please note that this policy does not work when `in-memory format` is set to `OBJECT`, since the memory footprint cannot be determined when data is put as `OBJECT`.

```
<max-size policy="USED_HEAP_SIZE">4096</max-size>
```

- **USED\_HEAP\_PERCENTAGE**: Maximum used heap size percentage per map for each Hazelcast instance. If, for example, a JVM is configured to have 1000 MB and this value is 10, then the map entries will be evicted when used heap size exceeds 100 MB. Please note that this policy does not work when [in-memory format](#) is set to **OBJECT**, since the memory footprint cannot be determined when data is put as **OBJECT**.

```
<max-size policy="USED_HEAP_PERCENTAGE">10</max-size>
```

- **FREE\_HEAP\_SIZE**: Minimum free heap size in megabytes for each JVM.

```
<max-size policy="FREE_HEAP_SIZE">512</max-size>
```

- **FREE\_HEAP\_PERCENTAGE**: Minimum free heap size percentage for each JVM. If, for example, a JVM is configured to have 1000 MB and this value is 10, then the map entries will be evicted when free heap size is below 100 MB.

```
<max-size policy="FREE_HEAP_PERCENTAGE">10</max-size>
```

- **USED\_NATIVE\_MEMORY\_SIZE**: (**Hazelcast IMDG Enterprise HD**) Maximum used native memory size in megabytes per map for each Hazelcast instance.

```
<max-size policy="USED_NATIVE_MEMORY_SIZE">1024</max-size>
```

- **USED\_NATIVE\_MEMORY\_PERCENTAGE**: (**Hazelcast IMDG Enterprise HD**) Maximum used native memory size percentage per map for each Hazelcast instance.

```
<max-size policy="USED_NATIVE_MEMORY_PERCENTAGE">65</max-size>
```

- **FREE\_NATIVE\_MEMORY\_SIZE**: (**Hazelcast IMDG Enterprise HD**) Minimum free native memory size in megabytes for each Hazelcast instance.

```
<max-size policy="FREE_NATIVE_MEMORY_SIZE">256</max-size>
```

- **FREE\_NATIVE\_MEMORY\_PERCENTAGE**: (**Hazelcast IMDG Enterprise HD**) Minimum free native memory size percentage for each Hazelcast instance.

```
<max-size policy="FREE_NATIVE_MEMORY_PERCENTAGE">5</max-size>
```



As of Hazelcast 3.7, the elements `eviction-percentage` and `min-eviction-check-millis` are deprecated. They will be ignored if configured since map eviction is based on the sampling of entries. Please see the [Eviction Algorithm section](#) for details.

To put it briefly, Hazelcast maps have no restrictions on the size and may grow arbitrarily large, by default. When it comes to reducing the size of a map, there are two concepts: expiration and eviction.

Expiration puts a limit on the maximum lifetime of an entry stored inside the map. When the entry expires it cannot be retrieved from the map any longer and at some point in time it will be cleaned out from the map to free up the memory. Expiration, and hence the eviction based on the expiration, can be configured using the element `time-to-live-seconds` and `max-idle-seconds` as described above.

Eviction puts a limit on the maximum size of the map. If the size of the map grows larger than the maximum allowed size, an eviction policy decides which item to evict from the map to reduce its size. The maximum allowed size can be configured using the element `max-size` and the eviction policy can be configured using the element `eviction-policy` as described above.

Eviction and expiration can be used together. In this case, the expiration configurations (`time-to-live-seconds` and `max-idle-seconds`) continue to work as usual cleaning out the expired entries regardless of the map size. Note that locked map entries are not the subjects for eviction and expiration.

### Example Eviction Configurations

```
<map name="documents">
  <max-size policy="PER_NODE">10000</max-size>
  <eviction-policy>LRU</eviction-policy>
  <max-idle-seconds>60</max-idle-seconds>
</map>
```

In the above example, `documents` map starts to evict its entries from a member when the map size exceeds 10000 in that member. Then the entries least recently used will be evicted. The entries not used for more than 60 seconds will be evicted as well.

And the following is an example eviction configuration for a map having `NATIVE` as the in-memory format:

```
<map name="nativeMap*">
  <in-memory-format>NATIVE</in-memory-format>
  <eviction-policy>LFU</eviction-policy>
  <max-size policy="USED_NATIVE_MEMORY_PERCENTAGE">99</max-size>
</map>
```

### Evicting Specific Entries

The eviction policies and configurations explained above apply to all the entries of a map. The entries that meet the specified eviction conditions are evicted.

If you want to evict some specific map entries, you can use the `ttl` and `ttlUnit` parameters of the method `map.put()`. An example code line is given below.

```
myMap.put( "1", "John", 50, TimeUnit.SECONDS )
```

The map entry with the key "1" will be evicted 50 seconds after it is put into `myMap`.

You may also use `map.setTTL` method to alter the time-to-live value of an existing entry. It is done as follows:

```
myMap.setTTL( "1", 50, TimeUnit.SECONDS )
```

In addition to the `ttl`, you may also specify a maximum idle timeout for specific map entries using

the `maxIdle` and `maxIdleUnit` parameters:

```
myMap.put( "1", "John", 50, TimeUnit.SECONDS, 40, TimeUnit.SECONDS )
```

Here `ttl` is set as 50 seconds and `maxIdle` is set as 40 seconds. The entry is considered to be evicted if at least one of these policies marks it as expired. If you want to specify only the `maxIdle` parameter, you need to set `ttl` as 0 seconds.

## Evicting All Entries

To evict all keys from the map except the locked ones, use the method `evictAll()`. If a `MapStore` is defined for the map, `deleteAll` is not called by `evictAll`. If you want to call the method `deleteAll`, use `clear()`.

An example is given below.

```
final int numberOfKeysToLock = 4;
final int numberOfEntriesToAdd = 1000;

HazelcastInstance node1 = Hazelcast.newHazelcastInstance();
HazelcastInstance node2 = Hazelcast.newHazelcastInstance();

IMap<Integer, Integer> map = node1.getMap( "map" );
for (int i = 0; i < numberOfEntriesToAdd; i++) {
    map.put(i, i);
}

for (int i = 0; i < numberOfKeysToLock; i++) {
    map.lock(i);
}

// should keep locked keys and evict all others.
map.evictAll();

System.out.printf("# After calling evictAll...\n");
System.out.printf("# Expected map size\t: %d\n", numberOfKeysToLock);
System.out.printf("# Actual map size\t: %d\n", map.size());
```



Only `EVICT_ALL` event is fired for any registered listeners.

## Forced Eviction

### Hazelcast IMDG Enterprise

Hazelcast may use forced eviction in the cases when the eviction explained in [Understanding Map Eviction](#) is not enough to free up your memory. Note that this is valid if you are using **Hazelcast IMDG Enterprise** and you set your in-memory format to `NATIVE`.

Forced eviction mechanism is explained below as steps in the given order:

- When the normal eviction is not enough, forced eviction is triggered and first it tries to evict approx. 20% of the entries from the current partition. It retries this five times.
- If the result of above step is still not enough, forced eviction applies the above step to all maps. This time it might perform eviction from some other partitions too, provided that they are owned by the same thread.
- If that is still not enough to free up your memory, it evicts not the 20% but all the entries from the current partition.
- If that is not enough, it will evict all the entries from the other data structures; from the partitions owned by the local thread.

Finally, when all the above steps are not enough, Hazelcast throws a `Native Out of Memory Exception`.

## Custom Eviction Policy



This section is valid for Hazelcast 3.7 and higher releases.

Apart from the policies such as LRU and LFU, which Hazelcast provides out-of-the-box, you can develop and use your own eviction policy.

To achieve this, you need to provide an implementation of `MapEvictionPolicy` as in the following `OddEvictor` example:

```
public class MapCustomEvictionPolicy {

    public static void main(String[] args) {
        Config config = new Config();
        config.getMapConfig("test")
            .setMapEvictionPolicy(new OddEvictor())
            .getMaxSizeConfig()
            .setMaxSizePolicy(PER_NODE).setSize(10000);

        HazelcastInstance instance = Hazelcast.newHazelcastInstance(config);
        IMap<Integer, Integer> map = instance.getMap("test");

        final Queue<Integer> oddKeys = new ConcurrentLinkedQueue<Integer>();
        final Queue<Integer> evenKeys = new ConcurrentLinkedQueue<Integer>();

        map.addEntryListener(new EntryEvictedListener<Integer, Integer>() {
            @Override
            public void entryEvicted(EntryEvent<Integer, Integer> event) {
                Integer key = event.getKey();
                if (key % 2 == 0) {
                    evenKeys.add(key);
                } else {
                    oddKeys.add(key);
                }
            }
        })
    }
}
```



```

    }, false);

    // wait some more time to receive evicted-events
    parkNanos(SECONDS.toNanos(5));

    for (int i = 0; i < 15000; i++) {
        map.put(i, i);
    }

    String msg = "IMap uses sampling based eviction. After eviction is completed,
we are expecting "
        + "number of evicted-odd-keys should be greater than number of
evicted-even-keys"
        + "\nNumber of evicted-odd-keys = %d, number of evicted-even-keys =
%d";
    out.println(format(msg, oddKeys.size(), evenKeys.size()));

    instance.shutdown();
}

/**
 * Odd evictor tries to evict odd keys first.
 */
private static class OddEvictor extends MapEvictionPolicy {

    @Override
    public int compare(EntryView o1, EntryView o2) {
        Integer key = (Integer) o1.getKey();
        if (key % 2 != 0) {
            return -1;
        }

        return 1;
    }
}
}

```

Then you can enable your policy by setting it via the method `MapConfig.setMapEvictionPolicy()` programmatically or via XML declaratively. Following is the example declarative configuration for the eviction policy `OddEvictor` implemented above:

```

<map name="test">
    ...
    <map-eviction-policy-class-name>com.package.OddEvictor</map-eviction-policy-class-
name>
    ....
</map>

```

If you Hazelcast with Spring, you can enable your policy as shown below.

```
<hz:map name="test">
  <hz:map-eviction-policy class-name="com.package.OddEvictor"/>
</hz:map>
```

## 7.2.5. Setting In-Memory Format

IMap (and a few other Hazelcast data structures, such as ICache) has an `in-memory-format` configuration option. By default, Hazelcast stores data into memory in binary (serialized) format. Sometimes it can be efficient to store the entries in their object form, especially in cases of local processing, such as entry processor and queries.

To set how the data will be stored in memory, set `in-memory-format` in the configuration. You have the following format options:

- **BINARY** (default): The data (both the key and value) will be stored in serialized binary format. You can use this option if you mostly perform regular map operations, such as `put` and `get`.
- **OBJECT**: The data will be stored in deserialized form. This configuration is good for maps where entry processing and queries form the majority of all operations and the objects are complex, making the serialization cost comparatively high. By storing objects, entry processing will not contain the deserialization cost. Note that when you use **OBJECT** as the in-memory format, the key will still be stored in binary format and the value will be stored in object format.
- **NATIVE**: (**Hazelcast IMDG Enterprise HD**) This format behaves the same as **BINARY**, however, instead of heap memory, key and value will be stored in the off-heap memory.

Regular operations like `get` rely on the object instance. When the **OBJECT** format is used and a `get` is performed, the map does not return the stored instance, but creates a clone. Therefore, this whole `get` operation first includes a serialization on the member owning the instance and then a deserialization on the member calling the instance. When the **BINARY** format is used, only a deserialization is required; **BINARY** is faster.

Similarly, a `put` operation is faster when the **BINARY** format is used. If the format was **OBJECT**, the map would create a clone of the instance, and there would first be a serialization and then a deserialization. When **BINARY** is used, only a deserialization is needed.



If a value is stored in **OBJECT** format, a change on a returned value does not affect the stored instance. In this case, the returned instance is not the actual one but a clone. Therefore, changes made on an object after it is returned will not reflect on the actual stored data. Similarly, when a value is written to a map and the value is stored in **OBJECT** format, it will be a copy of the `put` value. Therefore, changes made on the object after it is stored will not reflect on the stored data.

## 7.2.6. Using High-Density Memory Store with Map

### Hazelcast IMDG Enterprise HD

Hazelcast instances are Java programs. In case of **BINARY** and **OBJECT** in-memory formats, Hazelcast stores your distributed data into the heap of its server instances. Java heap is subject to garbage

collection (GC). In case of larger heaps, garbage collection might cause your application to pause for tens of seconds (even minutes for really large heaps), badly affecting your application performance and response times.

As the data gets bigger, you either run the application with larger heap, which would result in longer GC pauses or run multiple instances with smaller heap which can turn into an operational nightmare if the number of such instances becomes very high.

To overcome this challenge, Hazelcast offers High-Density Memory Store for your maps. You can configure your map to use High-Density Memory Store by setting the in-memory format to **NATIVE**. The following snippet is the declarative configuration example.

```
<map name="nativeMap*">
  <in-memory-format>NATIVE</in-memory-format>
</map>
```

Keep in mind that you should have already enabled the High-Density Memory Store usage for your cluster. Please see [Configuring High-Density Memory Store section](#).

### Required configuration changes when using NATIVE

Note that the eviction mechanism is different for **NATIVE** in-memory format. The new eviction algorithm for map with High-Density Memory Store is similar to that of JCache with High-Density Memory Store and is described [here](#).

- Eviction percentage has no effect.

```
<map name="nativeMap*">
  <in-memory-format>NATIVE</in-memory-format>
  <eviction-percentage>25</eviction-percentage> <!--! NO IMPACT with NATIVE -->
</map>
```

- These IMap eviction policies for **max-size** cannot be used: **FREE\_HEAP\_PERCENTAGE**, **FREE\_HEAP\_SIZE**, **USED\_HEAP\_PERCENTAGE**, **USED\_HEAP\_SIZE**.
- Near Cache eviction configuration is also different for **NATIVE** in-memory format. For a Near Cache configuration with in-memory format set to **BINARY**:

```
<map name="nativeMap*">
  <near-cache>
    <in-memory-format>BINARY</in-memory-format>
    <max-size>10000</max-size> <!--! NO IMPACT with NATIVE -->
    <eviction-policy>LFU</eviction-policy> <!--! NO IMPACT with NATIVE -->
  </near-cache>
</map>
```

the equivalent configuration for **NATIVE** in-memory format would be similar to the following:

```
<map name="nativeMap*">
  <near-cache>
    <in-memory-format>NATIVE</in-memory-format>
    <eviction size="10000" eviction-policy="LFU" max-size-policy=
"USED_NATIVE_MEMORY_SIZE"/> <!--! Correct configuration with NATIVE -->
  </near-cache>
</map>
```

- Near Cache eviction policy `ENTRY_COUNT` cannot be used for `max-size-policy`.



Please refer to the [High-Density Memory Store section](#) for more information.

## 7.2.7. Loading and Storing Persistent Data

Hazelcast allows you to load and store the distributed map entries from/to a persistent data store such as a relational database. To do this, you can use Hazelcast's `MapStore` and `MapLoader` interfaces.

When you provide a `MapLoader` implementation and request an entry (`IMap.get()`) that does not exist in memory, `MapLoader`'s `load` method will load that entry from the data store. This loaded entry is placed into the map and will stay there until it is removed or evicted.

When a `MapStore` implementation is provided, an entry is also put into a user defined data store.



Data store needs to be a centralized system that is accessible from all Hazelcast members. Persistence to a local file system is not supported.



Also note that the `MapStore` interface extends the `MapLoader` interface as you can see in the interface [code](#).



Starting with Hazelcast IMDG 3.11, all loads can be listened via `EntryLoadedListener`.

Following is a `MapStore` example.

```
public class PersonMapStore implements MapStore<Long, Person> {

    private final Connection con;
    private final PreparedStatement allKeysStatement;

    public PersonMapStore() {
        try {
            con = DriverManager.getConnection("jdbc:hsqldb:mydatabase", "SA", "");
            con.createStatement().executeUpdate(
                "create table if not exists person (id bigint not null, name
varchar(45), primary key (id))");
            allKeysStatement = con.prepareStatement("select id from person");
        } catch (SQLException e) {
```

```

        throw new RuntimeException(e);
    }
}

public synchronized void delete(Long key) {
    System.out.println("Delete:" + key);
    try {
        con.createStatement().executeUpdate(
            format("delete from person where id = %s", key));
    } catch (SQLException e) {
        throw new RuntimeException(e);
    }
}

public synchronized void store(Long key, Person value) {
    try {
        con.createStatement().executeUpdate(
            format("insert into person values(%s,'%s')", key, value.getName()
));
    } catch (SQLException e) {
        throw new RuntimeException(e);
    }
}

public synchronized void storeAll(Map<Long, Person> map) {
    for (Map.Entry<Long, Person> entry : map.entrySet()) {
        store(entry.getKey(), entry.getValue());
    }
}

public synchronized void deleteAll(Collection<Long> keys) {
    for (Long key : keys) {
        delete(key);
    }
}

public synchronized Person load(Long key) {
    try {
        ResultSet resultSet = con.createStatement().executeQuery(
            format("select name from person where id =%s", key));
        try {
            if (!resultSet.next()) {
                return null;
            }
            String name = resultSet.getString(1);
            return new Person(key, name);
        } finally {
            resultSet.close();
        }
    } catch (SQLException e) {
        throw new RuntimeException(e);
    }
}

```

```

    }
}

public synchronized Map<Long, Person> loadAll(Collection<Long> keys) {
    Map<Long, Person> result = new HashMap<Long, Person>();
    for (Long key : keys) {
        result.put(key, load(key));
    }
    return result;
}

public Iterable<Long> loadAllKeys() {
    return new StatementIterable<Long>(allKeysStatement);
}
}

```



During the initial loading process, MapStore uses a thread different from the partition threads that are used by the ExecutorService. After the initialization is completed, the `map.get` method looks up any nonexistent value from the database in a partition thread, or the `map.put` method looks up the database to return the previously associated value for a key also in a partition thread.



For more MapStore/MapLoader code samples, please see [here](#).

Hazelcast supports read-through, write-through and write-behind persistence modes, which are explained in the subsections below.

### Using Read-Through Persistence

If an entry does not exist in memory when an application asks for it, Hazelcast asks the loader implementation to load that entry from the data store. If the entry exists there, the loader implementation gets it, hands it to Hazelcast, and Hazelcast puts it into memory. This is read-through persistence mode.

### Setting Write-Through Persistence

MapStore can be configured to be write-through by setting the `write-delay-seconds` property to `0`. This means the entries will be put to the data store synchronously.

In this mode, when the `map.put(key, value)` call returns:

- `MapStore.store(key, value)` is successfully called so the entry is persisted.
- In-Memory entry is updated.
- In-Memory backup copies are successfully created on other cluster members (if `backup-count` is greater than 0).

If MapStore throws an exception then the exception is propagated to the original `put` or `remove` call in the form of `RuntimeException`.



There is a key difference in the behaviors of `map.remove(key)` and `map.delete(key)`, i.e., the latter results in `MapStore.delete(key)` to be invoked whereas the former only removes the entry from `IMap`.

## Setting Write-Behind Persistence

You can configure `MapStore` as write-behind by setting the `write-delay-seconds` property to a value bigger than `0`. This means the modified entries will be put to the data store asynchronously after a configured delay.



In write-behind mode, Hazelcast coalesces updates on a specific key by default, which means it applies only the last update on that key. However, you can set `MapStoreConfig.setWriteCoalescing()` to `FALSE` and you can store all updates performed on a key to the data store.



When you set `MapStoreConfig.setWriteCoalescing()` to `FALSE`, after you reached per-node maximum write-behind-queue capacity, subsequent put operations will fail with `ReachedMaxSizeException`. This exception will be thrown to prevent uncontrolled grow of write-behind queues. You can set per-node maximum capacity using the system property `hazelcast.map.write.behind.queue.capacity`. Please refer to the [System Properties section](#) for information on this property and how to set the system properties.

In write-behind mode, when the `map.put(key, value)` call returns:

- In-Memory entry is updated.
- In-Memory backup copies are successfully created on other cluster members (if `backup-count` is greater than `0`).
- The entry is marked as dirty so that after `write-delay-seconds`, it can be persisted with `MapStore.store(key, value)` call.
- For fault tolerance, dirty entries are stored in a queue on the primary member and also on a back-up member.

The same behavior goes for the `map.remove(key)`, the only difference is that `MapStore.delete(key)` is called when the entry will be deleted.

If `MapStore` throws an exception, then Hazelcast tries to store the entry again. If the entry still cannot be stored, a log message is printed and the entry is re-queued.

For batch write operations, which are only allowed in write-behind mode, Hazelcast will call `MapStore.storeAll(map)` and `MapStore.deleteAll(collection)` to do all writes in a single call.



If a map entry is marked as dirty, meaning that it is waiting to be persisted to the `MapStore` in a write-behind scenario, the eviction process forces the entry to be stored. This way you have control over the number of entries waiting to be stored, and thus you can prevent a possible `OutOfMemory` exception.



**MapStore** or **MapLoader** implementations should not use Hazelcast Map/Queue/MultiMap/List/Set operations. Your implementation should only work with your data store. Otherwise, you may get into deadlock situations.

Here is a sample configuration:

```
<hazelcast>
...
<map name="default">
...
<map-store enabled="true" initial-mode="LAZY">
  <class-name>com.hazelcast.examples.DummyStore</class-name>
  <write-delay-seconds>60</write-delay-seconds>
  <write-batch-size>1000</write-batch-size>
  <write-coalescing>true</write-coalescing>
</map-store>
</map>
</hazelcast>
```

The following are the descriptions of MapStore configuration elements and attributes:

- **class-name**: Name of the class implementing MapLoader and/or MapStore.
- **write-delay-seconds**: Number of seconds to delay to call the MapStore.store(key, value). If the value is zero then it is write-through so MapStore.store(key, value) will be called as soon as the entry is updated. Otherwise it is write-behind so updates will be stored after write-delay-seconds value by calling Hazelcast.storeAll(map). Its default value is 0.
- **write-batch-size**: Used to create batch chunks when writing map store. In default mode, all map entries will be tried to be written in one go. To create batch chunks, the minimum meaningful value for write-batch-size is 2. For values smaller than 2, it works as in default mode.
- **write-coalescing**: In write-behind mode, Hazelcast coalesces updates on a specific key by default; it applies only the last update on it. You can set this element to **false** to store all updates performed on a key to the data store.
- **enabled**: True to enable this map-store, false to disable. Its default value is true.
- **initial-mode**: Sets the initial load mode. LAZY is the default load mode, where load is asynchronous. EAGER means load is blocked till all partitions are loaded. Please see the [Initializing Map on Startup section](#) for more details.

## Storing Entries to Multiple Maps

A configuration can be applied to more than one map using wildcards (see [Using Wildcards](#)), meaning that the configuration is shared among the maps. But **MapStore** does not know which entries to store when there is one configuration applied to multiple maps.

To store entries when there is one configuration applied to multiple maps, use Hazelcast's **MapStoreFactory** interface. Using the **MapStoreFactory** interface, `MapStore`s` for each map can be created when a wildcard configuration is used. Example code is shown below.



```

Config config = new Config();
MapConfig mapConfig = config.getMapConfig( "*" );
MapStoreConfig mapStoreConfig = mapConfig.getMapStoreConfig();
mapStoreConfig.setFactoryImplementation( new MapStoreFactory<Object, Object>() {
    @Override
    public MapLoader<Object, Object> newMapStore( String mapName, Properties properties
) {
    return null;
    }
});

```

To initialize the `MapLoader` implementation with the given map name, configuration properties and the Hazelcast instance, implement the `MapLoaderLifecycleSupport` interface. This interface has the methods `init()` and `destroy()`.

The method `init()` initializes the `MapLoader` implementation. Hazelcast calls this method when the map is first used on the Hazelcast instance. The `MapLoader` implementation can initialize the required resources for implementing `MapLoader` such as reading a configuration file or creating a database connection.

Hazelcast calls the method `destroy()` before shutting down. You can override this method to cleanup the resources held by this `MapLoader` implementation, such as closing the database connections.

### Initializing Map on Startup

To pre-populate the in-memory map when the map is first touched/used, use the `MapLoader.loadAllKeys` API.

If `MapLoader.loadAllKeys` returns NULL, then nothing will be loaded. Your `MapLoader.loadAllKeys` implementation can return all or some of the keys. For example, you may select and return only the keys which are most important to you that you want to load them while initializing the map. `MapLoader.loadAllKeys` is the fastest way of pre-populating the map since Hazelcast will optimize the loading process by having each cluster member load its owned portion of the entries.

The `InitialLoadMode` configuration parameter in the class `MapStoreConfig` has two values: `LAZY` and `EAGER`. If `InitialLoadMode` is set to `LAZY`, data is not loaded during the map creation. If it is set to `EAGER`, all the data is loaded while the map is created and everything becomes ready to use. Also, if you add indices to your map with the `MapIndexConfig` class or the `addIndex` method, then `InitialLoadMode` is overridden and `MapStoreConfig` behaves as if `EAGER` mode is on.

Here is the `MapLoader` initialization flow:

1. When `getMap()` is first called from any member, initialization will start depending on the value of `InitialLoadMode`. If it is set to `EAGER`, initialization starts on all partitions as soon as the map is touched, i.e., all partitions will be loaded when `getMap` is called. If it is set to `LAZY`, data will be loaded partition by partition, i.e., each partition will be loaded with its first touch.
2. Hazelcast will call `MapLoader.loadAllKeys()` to get all your keys on one of the members.

3. That member will distribute keys to all other members in batches.
4. Each member will load values of all its owned keys by calling `MapLoader.loadAll(keys)`.
5. Each member puts its owned entries into the map by calling `IMap.putTransient(key, value)`.



If the load mode is `LAZY` and the `clear()` method is called (which triggers `MapStore.deleteAll()`), Hazelcast will remove **ONLY** the loaded entries from your map and datastore. Since all the data is not loaded in this case (`LAZY` mode), please note that there may still be entries in your datastore.\*



If you do not want the MapStore start to load as soon as the first cluster member starts, you can use the system property `hazelcast.initial.min.cluster.size`. For example, if you set its value as `3`, loading process will be blocked until all three members are completely up.\*



The return type of `loadAllKeys()` is changed from `Set` to `Iterable` with the release of Hazelcast 3.5. `MapLoader` implementations from previous releases are also supported and do not need to be adapted.

### Loading Keys Incrementally

If the number of keys to load is large, it is more efficient to load them incrementally rather than loading them all at once. To support incremental loading, the `MapLoader.loadAllKeys()` method returns an `Iterable` which can be lazily populated with the results of a database query.

Hazelcast iterates over the `Iterable` and, while doing so, sends out the keys to their respective owner members. The `Iterator` obtained from `MapLoader.loadAllKeys()` may also implement the `Closeable` interface, in which case `Iterator` is closed once the iteration is over. This is intended for releasing resources such as closing a JDBC result set.

### Forcing All Keys To Be Loaded

The method `loadAll` loads some or all keys into a data store in order to optimize the multiple load operations. The method has two signatures; the same method can take two different parameter lists. One signature loads the given keys and the other loads all keys. Please see the example code below.

```

final int numberOfEntriesToAdd = 1000;
final String mapName = LoadAll.class.getCanonicalName();
final Config config = createNewConfig(mapName);
final HazelcastInstance node = Hazelcast.newHazelcastInstance(config);
final IMap<Integer, Integer> map = node.getMap(mapName);

populateMap(map, numberOfEntriesToAdd);
System.out.printf("# Map store has %d elements\n", numberOfEntriesToAdd);

map.evictAll();
System.out.printf("# After evictAll map size\t: %d\n", map.size());

map.loadAll(true);
System.out.printf("# After loadAll map size\t: %d\n", map.size());

```

## Post-Processing Objects in Map Store

In some scenarios, you may need to modify the object after storing it into the map store. For example, you can get an ID or version auto-generated by your database and then need to modify your object stored in the distributed map, but not to break the synchronization between the database and the data grid.

To post-process an object in the map store, implement the `PostProcessingMapStore` interface to put the modified object into the distributed map. This will trigger an extra step of `Serialization`, so use it only when needed. (This is only valid when using the `write-through` map store configuration.)

Here is an example of post processing map store:

```

class ProcessingStore implements MapStore<Integer, Employee>, PostProcessingMapStore {
    @Override
    public void store( Integer key, Employee employee ) {
        EmployeeId id = saveEmployee();
        employee.setId( id.getId() );
    }
}

```



Please note that if you are using a post processing map store in combination with entry processors, post-processed values will not be carried to backups.

## Accessing a Database Using Properties

You can prepare your own `MapLoader` to access a database such as Cassandra and MongoDB. For this, you can first declaratively specify the database properties in your `hazelcast.xml` configuration file and then implement the `MapLoaderLifecycleSupport` interface to pass those properties.

You can define the database properties, such as its URL and name, using the `properties` configuration element. The following is a configuration example for MongoDB:

```

<map name="supplements">
  <map-store enabled="true" initial-mode="LAZY">
    <class-name>com.hazelcast.loader.YourMapStoreImplementation</class-name>
    <properties>
      <property name="mongo.url">mongodb://localhost:27017</property>
      <property name="mongo.db">mydb</property>
      <property name="mongo.collection">supplements</property>
    </properties>
  </map-store>
</map>

```

After you specified the database properties in your configuration, you need to implement the `MapLoaderLifecycleSupport` interface and give those properties in the `init()` method, as shown below:

```

public class YourMapStoreImplementation implements MapStore<String, Supplement>,
MapLoaderLifecycleSupport {

    private MongoClient mongoClient;
    private MongoCollection collection;

    public YourMapStoreImplementation() {
    }

    @Override
    public void init(HazelcastInstance hazelcastInstance, Properties properties,
String mapName) {
        String mongoUrl = (String) properties.get("mongo.url");
        String dbName = (String) properties.get("mongo.db");
        String collectionName = (String) properties.get("mongo.collection");
        this.mongoClient = new MongoClient(new MongoClientURI(mongoUrl));
        this.collection = mongoClient.getDatabase(dbName).getCollection(
collectionName);
    }
}

```

You can refer to the full example [here](#).

## 7.2.8. Creating Near Cache for Map

The Hazelcast distributed map supports a local Near Cache for remotely stored entries to increase the performance of local read operations. Please refer to the [Near Cache section](#) for a detailed explanation of the Near Cache feature and its configuration.

## 7.2.9. Locking Maps

Hazelcast Distributed Map (IMap) is thread-safe to meet your thread safety requirements. When these requirements increase or you want to have more control on the concurrency, consider the Hazelcast solutions described here.

Let's work on a sample case as shown below.

```
public class RacyUpdateMember {
    public static void main( String[] args ) throws Exception {
        HazelcastInstance hz = Hazelcast.newHazelcastInstance();
        IMap<String, Value> map = hz.getMap( "map" );
        String key = "1";
        map.put( key, new Value() );
        System.out.println( "Starting" );
        for ( int k = 0; k < 1000; k++ ) {
            if ( k % 100 == 0 ) System.out.println( "At: " + k );
            Value value = map.get( key );
            Thread.sleep( 10 );
            value.amount++;
            map.put( key, value );
        }
        System.out.println( "Finished! Result = " + map.get(key).amount );
    }

    static class Value implements Serializable {
        public int amount;
    }
}
```

If the above code is run by more than one cluster member simultaneously, a race condition is likely. You can solve this condition with Hazelcast using either pessimistic locking or optimistic locking.

### Pessimistic Locking

One way to solve the race issue is by using pessimistic locking - lock the map entry until you are finished with it.

To perform pessimistic locking, use the lock mechanism provided by the Hazelcast distributed map, i.e., the `map.lock` and `map.unlock` methods. See the below example code.

```

public class PessimisticUpdateMember {
    public static void main( String[] args ) throws Exception {
        HazelcastInstance hz = Hazelcast.newHazelcastInstance();
        IMap<String, Value> map = hz.getMap( "map" );
        String key = "1";
        map.put( key, new Value() );
        System.out.println( "Starting" );
        for ( int k = 0; k < 1000; k++ ) {
            map.lock( key );
            try {
                Value value = map.get( key );
                Thread.sleep( 10 );
                value.amount++;
                map.put( key, value );
            } finally {
                map.unlock( key );
            }
        }
        System.out.println( "Finished! Result = " + map.get( key ).amount );
    }

    static class Value implements Serializable {
        public int amount;
    }
}

```

The IMap lock will automatically be collected by the garbage collector when the lock is released and no other waiting conditions exist on the lock.

The IMap lock is reentrant, but it does not support fairness.

Another way to solve the race issue is by acquiring a predictable **Lock** object from Hazelcast. This way, every value in the map can be given a lock, or you can create a stripe of locks.

## Optimistic Locking

In Hazelcast, you can apply the optimistic locking strategy with the map's **replace** method. This method compares values in object or data forms depending on the in-memory format configuration. If the values are equal, it replaces the old value with the new one. If you want to use your defined **equals** method, **in-memory-format** should be **OBJECT**. Otherwise, Hazelcast serializes objects to **BINARY** forms and compares them.

See the below example code.



The below example code is intentionally broken.

```

public class OptimisticMember {
    public static void main( String[] args ) throws Exception {
        HazelcastInstance hz = Hazelcast.newHazelcastInstance();
        IMap<String, Value> map = hz.getMap( "map" );
        String key = "1";
        map.put( key, new Value() );
        System.out.println( "Starting" );
        for ( int k = 0; k < 1000; k++ ) {
            if ( k % 10 == 0 ) System.out.println( "At: " + k );
            for ( ; ; ) {
                Value oldValue = map.get( key );
                Value newValue = new Value( oldValue );
                Thread.sleep( 10 );
                newValue.amount++;
                if ( map.replace( key, oldValue, newValue ) )
                    break;
            }
        }
        System.out.println( "Finished! Result = " + map.get( key ).amount );
    }

    static class Value implements Serializable {
        public int amount;

        public Value() {
        }

        public Value( Value that ) {
            this.amount = that.amount;
        }

        public boolean equals( Object o ) {
            if ( o == this ) return true;
            if ( !( o instanceof Value ) ) return false;
            Value that = ( Value ) o;
            return that.amount == this.amount;
        }
    }
}

```

## Pessimistic vs. Optimistic Locking

The locking strategy you choose will depend on your locking requirements.

Optimistic locking is better for mostly read-only systems. It has a performance boost over pessimistic locking.

Pessimistic locking is good if there are lots of updates on the same key. It is more robust than optimistic locking from the perspective of data consistency.

In Hazelcast, use `IExecutorService` to submit a task to a key owner, or to a member or members. This is the recommended way to perform task executions, rather than using pessimistic or optimistic locking techniques. `IExecutorService` will have fewer network hops and less data over wire, and tasks will be executed very near to the data. Please refer to the [Data Affinity section](#).

## Solving the ABA Problem

The ABA problem occurs in environments when a shared resource is open to change by multiple threads. Even if one thread sees the same value for a particular key in consecutive reads, it does not mean that nothing has changed between the reads. Another thread may change the value, do work and change the value back, while the first thread thinks that nothing has changed.

To prevent these kind of problems, you can assign a version number and check it before any write to be sure that nothing has changed between consecutive reads. Although all the other fields will be equal, the version field will prevent objects from being seen as equal. This is the optimistic locking strategy; it is used in environments that do not expect intensive concurrent changes on a specific key.

In Hazelcast, you can apply the [optimistic locking](#) strategy with the map `replace` method.

## Lock Split-Brain Protection with Pessimistic Locking

Locks can be configured to check the number of currently present members before applying a locking operation. If the check fails, the lock operation will fail with a `QuorumException` (see [Split-Brain Protection](#)). As pessimistic locking uses lock operations internally, it will also use the configured lock quorum. This means that you can configure a lock quorum with the same name or a pattern that matches the map name. Note that the quorum for IMap locking actions can be different from the quorum for other IMap actions.

The following actions will then check for lock quorum before being applied:

- `IMap.lock(K)` and `IMap.lock(K, long, java.util.concurrent.TimeUnit)`
- `IMap.isLocked()`
- `IMap.tryLock(K)`, `IMap.tryLock(K, long, java.util.concurrent.TimeUnit)` and `IMap.tryLock(K, long, java.util.concurrent.TimeUnit, long, java.util.concurrent.TimeUnit)`
- `IMap.unlock()`
- `IMap.forceUnlock()`
- `MultiMap.lock(K)` and `MultiMap.lock(K, long, java.util.concurrent.TimeUnit)`
- `MultiMap.isLocked()`
- `MultiMap.tryLock(K)`, `MultiMap.tryLock(K, long, java.util.concurrent.TimeUnit)` and `MultiMap.tryLock(K, long, java.util.concurrent.TimeUnit, long, java.util.concurrent.TimeUnit)`
- `MultiMap.unlock()`
- `MultiMap.forceUnlock()`

An example of declarative configuration:



```

<map name="myMap">
  <quorum-ref>map-actions-quorum</quorum-ref>
</map>

<lock name="myMap">
  <quorum-ref>map-lock-actions-quorum</quorum-ref>
</lock>

```

Here the configured map will use the `map-lock-actions-quorum` quorum for map lock actions and the `map-actions-quorum` quorum for other map actions.

## 7.2.10. Accessing Entry Statistics

Hazelcast keeps statistics about each map entry, such as creation time, last update time, last access time, number of hits and version. To access the map entry statistics, use an `IMap.getEntryView(key)` call. Here is an example.

```

HazelcastInstance hz = Hazelcast.newHazelcastInstance();
EntryView entry = hz.getMap( "quotes" ).getEntryView( "1" );
System.out.println ( "size in memory : " + entry.getCost() );
System.out.println ( "creationTime : " + entry.getCreationTime() );
System.out.println ( "expirationTime : " + entry.getExpirationTime() );
System.out.println ( "number of hits : " + entry.getHits() );
System.out.println ( "lastAccessedTime: " + entry.getLastAccessTime() );
System.out.println ( "lastUpdateTime : " + entry.getLastUpdateTime() );
System.out.println ( "version : " + entry.getVersion() );
System.out.println ( "key : " + entry.getKey() );
System.out.println ( "value : " + entry.getValue() );

```

## 7.2.11. Map Listener

Please refer to the [Listening for Map Events section](#).

## 7.2.12. Listening to Map Entries with Predicates

You can listen to the modifications performed on specific map entries. You can think of it as an entry listener with predicates. Please see the [Listening for Map Events section](#) for information on how to add entry listeners to a map.



The default backwards-compatible event publishing strategy only publishes **UPDATED** events when map entries are updated to a value that matches the predicate with which the listener was registered. This implies that when using the default event publishing strategy, your listener will not be notified about an entry whose value is updated from one that matches the predicate to a new value that does not match the predicate.

Since version 3.7, when you configure Hazelcast members with property

`hazelcast.map.entry.filtering.natural.event.types` set to `true`, handling of entry updates conceptually treats value transition as entry, update or exit with regards to the predicate value space. The following table compares how a listener is notified about an update to a map entry value under the default backwards-compatible Hazelcast behavior (when property `hazelcast.map.entry.filtering.natural.event.types` is not set or is set to `false`) versus when set to `true`:

	Default	<code>hazelcast.map.entry.filtering.natural.event.types = true</code>
When old value matches predicate, new value does not match predicate	No event is delivered to entry listener	<b>REMOVED</b> event is delivered to entry listener
When old value matches predicate, new value matches predicate	<b>UPDATED</b> event is delivered to entry listener	<b>UPDATED</b> event is delivered to entry listener
When old value does not match predicate, new value does not match predicate	No event is delivered to entry listener	No event is delivered to entry listener
When old value does not match predicate, new value matches predicate	<b>UPDATED</b> event is delivered to entry listener	<b>ADDED</b> event is delivered to entry listener

As an example, let's listen to the changes made on an employee with the surname "Smith". First, let's create the `Employee` class.

```
public class Employee implements Serializable {

    private final String surname;

    public Employee(String surname) {
        this.surname = surname;
    }

    @Override
    public String toString() {
        return "Employee{" +
            "surname='" + surname + '\'' +
            '}';
    }
}
```

Then, let's create a listener with predicate by adding a listener that tracks **ADDED**, **UPDATED** and **REMOVED** entry events with the `surname` predicate.

```

public class ListenerWithPredicate {

    public static void main(String[] args) {
        Config config = new Config();
        config.setProperty("hazelcast.map.entry.filtering.natural.event.types", "true");

        HazelcastInstance hz = Hazelcast.newHazelcastInstance(config);
        IMap<String, String> map = hz.getMap("map");
        map.addEntryListener(new MyEntryListener(),
            new SqlPredicate("surname=smith"), true);
        System.out.println("Entry Listener registered");
    }

    static class MyEntryListener
        implements EntryAddedListener<String, String>,
            EntryUpdatedListener<String, String>,
            EntryRemovedListener<String, String> {

        @Override
        public void entryAdded(EntryEvent<String, String> event) {
            System.out.println("Entry Added:" + event);
        }

        @Override
        public void entryRemoved(EntryEvent<String, String> event) {
            System.out.println("Entry Removed:" + event);
        }

        @Override
        public void entryUpdated(EntryEvent<String, String> event) {
            System.out.println("Entry Updated:" + event);
        }
    }
}

```

And now, let's play with the employee "smith" and see how that employee will be listened to.

```

public class Modify {

    public static void main(String[] args) {
        Config config = new Config();
        config.setProperty("hazelcast.map.entry.filtering.natural.event.types", "true");
        HazelcastInstance hz = Hazelcast.newHazelcastInstance(config);
        IMap<String, Employee> map = hz.getMap("map");

        map.put("1", new Employee("smith"));
        map.put("2", new Employee("jordan"));
        System.out.println("done");
        System.exit(0);
    }
}

```

When you first run the class `ListenerWithPredicate` and then run `Modify`, you will see output similar to the listing below.

```

entryAdded:EntryEvent {Address[192.168.178.10]:5702} key=1,oldValue=null,
value=Person{name= smith }, event=ADDED, by Member [192.168.178.10]:5702

```



Please refer to [Continuous Query Cache](#) for more information.

### 7.2.13. Removing Map Entries in Bulk with Predicates

You can remove all map entries that match your predicate. For this, Hazelcast offers the method `removeAll()`. Its syntax is as follows:

```

void removeAll(Predicate<K, V> predicate);

```

Normally the map entries matching the predicate are found with a full scan of the map. If the entries are indexed, Hazelcast uses the index search to find them. With index, you can expect that finding the entries is faster.



When `removeAll()` is called, ALL entries in the caller member's Near Cache are also removed.

### 7.2.14. Adding Interceptors

You can add intercept operations and execute your own business logic synchronously blocking the operations. You can change the returned value from a `get` operation, change the value in `put`, or `cancel` operations by throwing an exception.

Interceptors are different from listeners. With listeners, you take an action after the operation has

been completed. Interceptor actions are synchronous and you can alter the behavior of operation, change its values, or totally cancel it.

Map interceptors are chained, so adding the same interceptor multiple times to the same map can result in duplicate effects. This can easily happen when the interceptor is added to the map at member initialization, so that each member adds the same interceptor. When you add the interceptor in this way, be sure to implement the `hashCode()` method to return the same value for every instance of the interceptor. It is not strictly necessary, but it is a good idea to also implement `equals()` as this will ensure that the map interceptor can be removed reliably.

The IMap API has two methods for adding and removing an interceptor to the map: `addInterceptor` and `removeInterceptor`. Please also refer to the [MapInterceptor interface](#) to see the methods used to intercept the changes in a map.

The following is an example usage.

```

public class MapInterceptorMember {

    public static void main(String[] args) {
        HazelcastInstance hz = Hazelcast.newHazelcastInstance();
        IMap<String, String> map = hz.getMap("themap");
        map.addInterceptor(new MyMapInterceptor());

        map.put("1", "1");
        System.out.println(map.get("1"));
    }

    private static class MyMapInterceptor implements MapInterceptor {

        @Override
        public Object interceptGet(Object value) {
            return value + "-foo";
        }

        @Override
        public void afterGet(Object value) {
        }

        @Override
        public Object interceptPut(Object oldValue, Object newValue) {
            return null;
        }

        @Override
        public void afterPut(Object value) {
        }

        @Override
        public Object interceptRemove(Object removedValue) {
            return null;
        }

        @Override
        public void afterRemove(Object value) {
        }
    }
}

```

## 7.2.15. Preventing Out of Memory Exceptions

It is very easy to trigger an out of memory exception (OOM) with query-based map methods, especially with large clusters or heap sizes. For example, on a cluster with five members having 10 GB of data and 25 GB heap size per member, a single call of `IMap.entrySet()` fetches 50 GB of data and crashes the calling instance.

A call of `IMap.values()` may return too much data for a single member. This can also happen with a real query and an unlucky choice of predicates, especially when the parameters are chosen by a user of your application.

To prevent this, you can configure a maximum result size limit for query based operations. This is not a limit like `SELECT * FROM map LIMIT 100`, which you can achieve by a [Paging Predicate](#). A maximum result size limit for query based operations is meant to be a last line of defense to prevent your members from retrieving more data than they can handle.

The Hazelcast component which calculates this limit is the `QueryResultSizeLimiter`.

### Setting Query Result Size Limit

If the `QueryResultSizeLimiter` is activated, it calculates a result size limit per partition. Each `QueryOperation` runs on all partitions of a member, so it collects result entries as long as the member limit is not exceeded. If that happens, a `QueryResultSizeExceededException` is thrown and propagated to the calling instance.

This feature depends on an equal distribution of the data on the cluster members to calculate the result size limit per member. Therefore, there is a minimum value defined in `QueryResultSizeLimiter.MINIMUM_MAX_RESULT_LIMIT`. Configured values below the minimum will be increased to the minimum.

### Local Pre-check

In addition to the distributed result size check in the `QueryOperations`, there is a local pre-check on the calling instance. If you call the method from a client, the pre-check is executed on the member that invokes the `QueryOperations`.

Since the local pre-check can increase the latency of a `QueryOperation`, you can configure how many local partitions should be considered for the pre-check, or you can deactivate the feature completely.

### Scope of Result Size Limit

Besides the designated query operations, there are other operations that use predicates internally. Those method calls will throw the `QueryResultSizeExceededException` as well. Please see the following matrix to see the methods that are covered by the query result size limit.

Method	MapProxyImpl	ClientMapProxyImpl	TransactionalMapProxy	ClientTxnMapProxy
values()	✓	✓	✓	✓
keySet()	✓	✓	✓	✓
entrySet()	✓	✓	n/a	n/a
values(predicate)	✓	✓	✓	✓
keySet(predicate)	✓	✓	✓	✓
entrySet(predicate)	✓	✓	n/a	n/a
localKeySet()	✓	n/a	n/a	n/a
localKeySet(predicate)	✓	n/a	n/a	n/a

Interfaces: **IMap** **TransactionalMap**

### Configuring Query Result Size

The query result size limit is configured via the following system properties.

- `hazelcast.query.result.size.limit`: Result size limit for query operations on maps. This value defines the maximum number of returned elements for a single query result. If a query exceeds this number of elements, a `QueryResultSizeExceededException` is thrown.
- `hazelcast.query.max.local.partition.limit.for.precheck`: Maximum value of local partitions to trigger local pre-check for `TruePredicate` query operations on maps.

Please refer to the [System Properties appendix](#) to see the full descriptions of these properties and how to set them.

## 7.3. Queue

Hazelcast distributed queue is an implementation of `java.util.concurrent.BlockingQueue`. Being distributed, Hazelcast distributed queue enables all cluster members to interact with it. Using Hazelcast distributed queue, you can add an item in one cluster member and remove it from another one.

### 7.3.1. Getting a Queue and Putting Items

Use the Hazelcast instance's `getQueue` method to get the queue, then use the queue's `put` method to put items into the queue.



```

HazelcastInstance hazelcastInstance = Hazelcast.newHazelcastInstance();
BlockingQueue<MyTask> queue = hazelcastInstance.getQueue( "tasks" );
queue.put( new MyTask() );
MyTask task = queue.take();

boolean offered = queue.offer( new MyTask(), 10, TimeUnit.SECONDS );
task = queue.poll( 5, TimeUnit.SECONDS );
if ( task != null ) {
    //process task
}

```

FIFO ordering will apply to all queue operations across the cluster. The user objects (such as `MyTask` in the example above) that are enqueued or dequeued have to be `Serializable`.

Hazelcast distributed queue performs no batching while iterating over the queue. All items will be copied locally and iteration will occur locally.

Hazelcast distributed queue uses `ItemListener` to listen to the events that occur when items are added to and removed from the queue. Please refer to the [Listening for Item Events](#) section for information on how to create an item listener class and register it.

### 7.3.2. Creating an Example Queue

The following example code illustrates a distributed queue that connects a producer and consumer.

#### Putting Items on the Queue

Let's `put` one integer on the queue every second, 100 integers total.

```

public class ProducerMember {

    public static void main( String[] args ) throws Exception {
        HazelcastInstance hz = Hazelcast.newHazelcastInstance();
        IQueue<Integer> queue = hz.getQueue( "queue" );
        for ( int k = 1; k < 100; k++ ) {
            queue.put( k );
            System.out.println( "Producing: " + k );
            Thread.sleep(1000);
        }
        queue.put( -1 );
        System.out.println( "Producer Finished!" );
    }
}

```

`Producer` puts a `-1` on the queue to show that the `put`'s are finished.

## Taking Items off the Queue

Now, let's create a `Consumer` class to `take` a message from this queue, as shown below.

```
public class ConsumerMember {  
  
    public static void main( String[] args ) throws Exception {  
        HazelcastInstance hz = Hazelcast.newHazelcastInstance();  
        IQueue<Integer> queue = hz.getQueue( "queue" );  
        while ( true ) {  
            int item = queue.take();  
            System.out.println( "Consumed: " + item );  
            if ( item == -1 ) {  
                queue.put( -1 );  
                break;  
            }  
            Thread.sleep( 5000 );  
        }  
        System.out.println( "Consumer Finished!" );  
    }  
}
```

As seen in the above example code, `Consumer` waits five seconds before it consumes the next message. It stops once it receives `-1`. Also note that `Consumer` puts `-1` back on the queue before the loop is ended.

When you first start `Producer` and then start `Consumer`, items produced on the queue will be consumed from the same queue.

## Balancing the Queue Operations

From the above example code, you can see that an item is produced every second and consumed every five seconds. Therefore, the consumer keeps growing. To balance the produce/consume operation, let's start another consumer. This way, consumption is distributed to these two consumers, as seen in the sample outputs below.

The second consumer is started. After a while, here is the first consumer output:

```
...  
Consumed 13  
Consumed 15  
Consumer 17  
...
```

Here is the second consumer output:

```
...
Consumed 14
Consumed 16
Consumer 18
...
```

In the case of a lot of producers and consumers for the queue, using a list of queues may solve the queue bottlenecks. In this case, be aware that the order of the messages sent to different queues is not guaranteed. Since in most cases strict ordering is not important, a list of queues is a good solution.



The items are taken from the queue in the same order they were put on the queue. However, if there is more than one consumer, this order is not guaranteed.

### ItemIDs When Offering Items

Hazelcast gives an `itemId` for each item you offer, which is an incrementing sequence identification for the queue items. You should consider the following to understand the `itemId` assignment behavior:

- When a Hazelcast member has a queue and that queue is configured to have at least one backup, and that member is restarted, the `itemId` assignment resumes from the last known highest `itemId` before the restart; `itemId` assignment does not start from the beginning for the new items.
- When the whole cluster is restarted, the same behavior explained in the above consideration applies if your queue has a persistent data store (`QueueStore`). If the queue has `QueueStore`, the `itemId` for the new items are given, starting from the highest `itemId` found in the IDs returned by the method `loadAllKeys`. If the method `loadAllKeys` does not return anything, the `itemId`'s will started from the beginning after a cluster restart.
- The above two considerations mean there will be no duplicated `itemId`'s in the memory or in the persistent data store.

### 7.3.3. Setting a Bounded Queue

A bounded queue is a queue with a limited capacity. When the bounded queue is full, no more items can be put into the queue until some items are taken out.

To turn a Hazelcast distributed queue into a bounded queue, set the capacity limit with the `max-size` property. You can set the `max-size` property in the configuration, as shown below. `max-size` specifies the maximum size of the queue. Once the queue size reaches this value, `put` operations will be blocked until the queue size goes below `max-size`, which happens when a consumer removes items from the queue.

Let's set **10** as the maximum size of our example queue in [Creating an Example Queue](#).

```
<hazelcast>
...
<queue name="queue">
  <max-size>10</max-size>
</queue>
...
</hazelcast>
```

When the producer is started, ten items are put into the queue and then the queue will not allow more `put` operations. When the consumer is started, it will remove items from the queue. This means that the producer can `put` more items into the queue until there are ten items in the queue again, at which point the `put` operation again becomes blocked.

In this example code, the producer is five times faster than the consumer. It will effectively always be waiting for the consumer to remove items before it can put more on the queue. For this example code, if maximum throughput is the goal, it would be a good option to start multiple consumers to prevent the queue from filling up.

### 7.3.4. Queueing with Persistent Datastore

Hazelcast allows you to load and store the distributed queue items from/to a persistent datastore using the interface `QueueStore`. If queue store is enabled, each item added to the queue will also be stored at the configured queue store. When the number of items in the queue exceeds the memory limit, the subsequent items are persisted in the queue store, they are not stored in the queue memory.

The `QueueStore` interface enables you to store, load and delete queue items with methods like `store`, `storeAll`, `load` and `delete`. The following example class includes all of the `QueueStore` methods.

```

public class TheQueueStore implements QueueStore<Item> {

    @Override
    public void delete(Long key) {
        System.out.println("delete");
    }

    @Override
    public void store(Long key, Item value) {
        System.out.println("store");
    }

    @Override
    public void storeAll(Map<Long, Item> map) {
        System.out.println("store all");
    }

    @Override
    public void deleteAll(Collection<Long> keys) {
        System.out.println("deleteAll");
    }

    @Override
    public Item load(Long key) {
        System.out.println("load");
        return null;
    }

    @Override
    public Map<Long, Item> loadAll(Collection<Long> keys) {
        System.out.println("loadALL");
        return null;
    }

    @Override
    public Set<Long> loadAllKeys() {
        System.out.println("loadAllKeys");
        return null;
    }
}

```

**Item** must be serializable. The following is an example queue store configuration.

```

<queue-store>
  <class-name>com.hazelcast.QueueStoreImpl</class-name>
  <properties>
    <property name="binary">>false</property>
    <property name="memory-limit">1000</property>
    <property name="bulk-load">500</property>
  </properties>
</queue-store>

```

Let's explain the queue store properties.

- **Binary:** By default, Hazelcast stores the queue items in serialized form, and before it inserts the queue items into the queue store, it deserializes them. If you are not reaching the queue store from an external application, you might prefer that the items be inserted in binary form. Do this by setting the `binary` property to true: then you can get rid of the deserialization step, which is a performance optimization. The `binary` property is false by default.
- **Memory Limit:** This is the number of items after which Hazelcast will store items only to the datastore. For example, if the memory limit is 1000, then the 1001st item will be put only to the datastore. This feature is useful when you want to avoid out-of-memory conditions. If you want to always use memory, you can set it to `Integer.MAX_VALUE`. The default number for `memory-limit` is 1000.
- **Bulk Load:** When the queue is initialized, items are loaded from `QueueStore` in bulks. Bulk load is the size of these bulks. The default value of `bulk-load` is 250.

### 7.3.5. Split-Brain Protection for Queue

Queues can be configured to check for a minimum number of available members before applying queue operations (see [Split-Brain Protection](#)). This is a check to avoid performing successful queue operations on all parts of a cluster during a network partition.

Following is a list of methods that now support Split-Brain Protection checks. The list is grouped by quorum type.

- WRITE, READ\_WRITE
  - `Collection.addAll()`
  - `Collection.removeAll()`, `Collection.retainAll()`
  - `BlockingQueue.offer()`, `BlockingQueue.add()`, `BlockingQueue.put()`
  - `BlockingQueue.drainTo()`
  - `IQueue.poll()`, `Queue.remove()`, `IQueue.take()`
  - `BlockingQueue.remove()`
- READ, READ\_WRITE
  - `Collection.clear()`
  - `Collection.containsAll()`, `BlockingQueue.contains()`
  - `Collection.isEmpty()`

- `Collection.iterator()`, `Collection.toArray()`
- `Queue.peek()`, `Queue.element()`
- `Collection.size()`
- `BlockingQueue.remainingCapacity()`

### 7.3.6. Configuring Queue

The following are examples of queue configurations. It includes the `QueueStore` configuration, which is explained in the [Queueing with Persistent Datastore](#) section.

#### Declarative:

```
<queue name="default">
  <max-size>0</max-size>
  <backup-count>1</backup-count>
  <async-backup-count>0</async-backup-count>
  <empty-queue-ttl>-1</empty-queue-ttl>
  <item-listeners>
    <item-listener>com.hazelcast.examples.ItemListener</item-listener>
  </item-listeners>
  <statistics-enabled>true</statistics-enabled>
  <queue-store>
    <class-name>com.hazelcast.QueueStoreImpl</class-name>
    <properties>
      <property name="binary">>false</property>
      <property name="memory-limit">10000</property>
      <property name="bulk-load">500</property>
    </properties>
  </queue-store>
  <quorum-ref>quorumname</quorum-ref>
</queue>
```

#### Programmatic:

```
Config config = new Config();
QueueConfig queueConfig = config.getQueueConfig("default");
queueConfig.setName("MyQueue")
    .setBackupCount(1)
    .setMaxSize(0)
    .setStatisticsEnabled(true)
    .setQuorumName("quorumname");
queueConfig.getQueueStoreConfig()
    .setEnabled(true)
    .setClassName("com.hazelcast.QueueStoreImpl")
    .setProperty("binary", "false");
config.addQueueConfig(queueConfig);
```

Hazelcast distributed queue has one synchronous backup by default. By having this backup, when a cluster member with a queue goes down, another member having the backup of that queue will continue. Therefore, no items are lost. You can define the number of synchronous backups for a queue using the `backup-count` element in the declarative configuration. A queue can also have asynchronous backups: you can define the number of asynchronous backups using the `async-backup-count` element.

To set the maximum size of the queue, use the `max-size` element. To purge unused or empty queues after a period of time, use the `empty-queue-ttl` element. If you define a value (time in seconds) for the `empty-queue-ttl` element, then your queue will be destroyed if it stays empty or unused for the time in seconds that you give.

The following is the full list of queue configuration elements with their descriptions.

- `max-size`: Maximum number of items in the queue. It is used to set an upper bound for the queue. You will not be able to put more items when the queue reaches to this maximum size whether you have a queue store configured or not.
- `backup-count`: Number of synchronous backups. Queue is a non-partitioned data structure, so all entries of a queue reside in one partition. When this parameter is '1', it means there will be one backup of that queue in another member in the cluster. When it is '2', two members will have the backup.
- `async-backup-count`: Number of asynchronous backups.
- `empty-queue-ttl`: Used to purge unused or empty queues. If you define a value (time in seconds) for this element, then your queue will be destroyed if it stays empty or unused for that time.
- `item-listeners`: Adds listeners (listener classes) for the queue items. You can also set the attribute `include-value` to `true` if you want the item event to contain the item values. You can set `local` to `true` if you want to listen to the items on the local member.
- `queue-store`: Includes the queue store factory class name and the properties **binary**, **memory limit** and **bulk load**. Please refer to [Queueing with Persistent Datastore](#).
- `statistics-enabled`: If set to `true`, you can retrieve statistics for this queue using the method `getLocalQueueStats()`.
- `quorum-ref` : Name of quorum configuration that you want this queue to use.

## 7.4. MultiMap

Hazelcast `MultiMap` is a specialized map where you can store multiple values under a single key. Just like any other distributed data structure implementation in Hazelcast, `MultiMap` is distributed and thread-safe.

Hazelcast `MultiMap` is not an implementation of `java.util.Map` due to the difference in method signatures. It supports most features of Hazelcast Map except for indexing, predicates and MapLoader/MapStore. Yet, like Hazelcast Map, entries are almost evenly distributed onto all cluster members. When a new member joins the cluster, the same ownership logic used in the distributed map applies.



## 7.4.1. Getting a MultiMap and Putting an Entry

The following example creates a MultiMap and puts items into it. Use the HazelcastInstance `getMultiMap` method to get the MultiMap, then use the MultiMap `put` method to put an entry into the MultiMap.

```
HazelcastInstance hazelcastInstance = Hazelcast.newHazelcastInstance();
MultiMap<String, String> map = hazelcastInstance.getMultiMap("map");

map.put("a", "1");
map.put("a", "2");
map.put("b", "3");
System.out.println("PutMember:Done");
```

Now let's print the entries in this MultiMap.

```
HazelcastInstance hazelcastInstance = Hazelcast.newHazelcastInstance();
MultiMap<String, String> map = hazelcastInstance.getMultiMap("map");

map.put("a", "1");
map.put("a", "2");
map.put("b", "3");
System.out.printf("PutMember:Done");

for (String key: map.keySet()){
    Collection<String> values = map.get(key);
    System.out.printf("%s -> %s\n", key, values);
}
```

After you run the first code sample, run the `PrintMember` sample. You will see the key `a` has two values, as shown below.

```
b → [3]
```

```
a → [2, 1]
```

Hazelcast MultiMap uses `EntryListener` to listen to events which occur when entries are added to, updated in or removed from the MultiMap. Please refer to the [Listening for MultiMap Events section](#) for information on how to create an entry listener class and register it.

## 7.4.2. Configuring MultiMap

When using MultiMap, the collection type of the values can be either **Set** or **List**. Configure the collection type with the `valueCollectionType` parameter. If you choose `Set`, duplicate and null values are not allowed in your collection and ordering is irrelevant. If you choose `List`, ordering is relevant and your collection can include duplicate and null values.

You can also enable statistics for your MultiMap with the `statisticsEnabled` parameter. If you enable `statisticsEnabled`, statistics can be retrieved with `getLocalMultiMapStats()` method.



Currently, eviction is not supported for the MultiMap data structure.

The following are the example MultiMap configurations.

#### Declarative:

```
<multimap name="default">
  <backup-count>0</backup-count>
  <async-backup-count>1</async-backup-count>
  <value-collection-type>SET</value-collection-type>
  <entry-listeners>
    <entry-listener include-value="false" local="false"
  >com.hazelcast.examples.EntryListener</entry-listener>
  </entry-listeners>
  <quorum-ref>quorumname</quorum-ref>
</multimap>
```

#### Programmatic:

```
MultiMapConfig mmConfig = new MultiMapConfig();
mmConfig.setName( "default" )
    .setBackupCount( 0 ).setAsyncBackupCount( 1 )
    .setValueCollectionType( "SET" )
    .setQuorumName( "quorumname" );
```

The following are the configuration elements and their descriptions:

- **backup-count**: Defines the number of synchronous backups. For example, if it is set to 1, backup of a partition will be placed on one other member. If it is 2, it will be placed on two other members.
- **async-backup-count**: The number of asynchronous backups. Behavior is the same as that of the **backup-count** element.
- **statistics-enabled**: You can retrieve some statistics such as owned entry count, backup entry count, last update time and locked entry count by setting this parameter's value as "true". The method for retrieving the statistics is `getLocalMultiMapStats()`.
- **value-collection-type**: Type of the value collection. It can be **SET** or **LIST**.
- **entry-listeners**: Lets you add listeners (listener classes) for the map entries. You can also set the attribute `include-value` to true if you want the item event to contain the entry values. You can set `local` to true if you want to listen to the entries on the local member.
- **quorum-ref**: Name of quorum configuration that you want this MultiMap to use. Please see the [Split-Brain Protection for MultiMap and TransactionalMultiMap](#) section.

### 7.4.3. Split-Brain Protection for MultiMap and TransactionalMultiMap

MultiMap & TransactionalMultiMap can be configured to check for a minimum number of

available members before applying their operations (see [Split-Brain Protection](#)). This is a check to avoid performing successful queue operations on all parts of a cluster during a network partition.

Following is a list of methods that now support Split-Brain Protection checks. The list is grouped by quorum type.

MultiMap:

- WRITE, READ\_WRITE:
  - `clear`
  - `forceUnlock`
  - `lock`
  - `put`
  - `remove`
  - `tryLock`
  - `unlock`
- READ, READ\_WRITE:
  - `containsEntry`
  - `containsKey`
  - `containsValue`
  - `entrySet`
  - `get`
  - `isLocked`
  - `keySet`
  - `localKeySet`
  - `size`
  - `valueCount`
  - `values`

TransactionalMultiMap:

- WRITE, READ\_WRITE:
  - `put`
  - `remove`
- READ, READ\_WRITE:
  - `size`
  - `get`
  - `valueCount`

## Configuring Split-Brain Protection

Split-Brain protection for MultiMap can be configured programmatically using the method `setQuorumName()`, or declaratively using the element `quorum-ref`. Following is an example declarative configuration:

```
<multimap name="default">
  ...
  <quorum-ref>quorumname</quorum-ref>
  ...
</multimap>
```

The value of `quorum-ref` should be the quorum configuration name which you configured under the `quorum` element as explained in the [Split-Brain Protection section](#).

## 7.5. Set

Hazelcast Set is a distributed and concurrent implementation of `java.util.Set`.

- Hazelcast Set does not allow duplicate elements.
- Hazelcast Set does not preserve the order of elements.
- Hazelcast Set is a non-partitioned data structure—all the data that belongs to a set will live on one single partition in that member.
- Hazelcast Set cannot be scaled beyond the capacity of a single machine. Since the whole set lives on a single partition, storing a large amount of data on a single set may cause memory pressure. Therefore, you should use multiple sets to store a large amount of data. This way, all the sets will be spread across the cluster, sharing the load.
- A backup of Hazelcast Set is stored on a partition of another member in the cluster so that data is not lost in the event of a primary member failure.
- All items are copied to the local member and iteration occurs locally.
- The equals method implemented in Hazelcast Set uses a serialized byte version of objects, as opposed to `java.util.HashSet`.

### 7.5.1. Getting a Set and Putting Items

Use the HazelcastInstance `getSet` method to get the Set, then use the `add` method to put items into the Set.

```
HazelcastInstance hz = Hazelcast.newHazelcastInstance();
ISet<String> set = hz.getSet("set");
set.add("Tokyo");
set.add("Paris");
set.add("London");
set.add("New York");
System.out.println("Putting finished!");
```

Hazelcast Set uses `ItemListener` to listen to events that occur when items are added to and removed from the Set. Please refer to the [Listening for Item Events section](#) for information on how to create an item listener class and register it.

## 7.5.2. Configuring Set

The following are the example set configurations.

### Declarative:

```
<set name="default">
  <backup-count>1</backup-count>
  <async-backup-count>0</async-backup-count>
  <max-size>10</max-size>
  <item-listeners>
    <item-listener>com.hazelcast.examples.ItemListener</item-listener>
  </item-listeners>
  <quorum-ref>quorumname</quorum-ref>
</set>
```

### Programmatic:

```
Config config = new Config();
CollectionConfig collectionSet = config.getSetConfig("MySet");
collectionSet.setBackupCount(1)
    .setMaxSize(10)
    .setQuorumName("quorumname");
```

Set configuration has the following elements.

- **statistics-enabled**: True (default) if statistics gathering is enabled on the Set, false otherwise.
- **backup-count**: Count of synchronous backups. Set is a non-partitioned data structure, so all entries of a Set reside in one partition. When this parameter is '1', it means there will be one backup of that Set in another member in the cluster. When it is '2', two members will have the backup.
- **async-backup-count**: Count of asynchronous backups.
- **max-size**: The maximum number of entries for this Set. It can be any number between 0 and Integer.MAX\_VALUE. Its default value is 0, meaning there is no capacity constraint.
- **item-listeners**: Lets you add listeners (listener classes) for the list items. You can also set the attributes **include-value** to **true** if you want the item event to contain the item values. You can set **local** to **true** if you want to listen to the items on the local member.
- **quorum-ref**: Name of quorum configuration that you want this Set to use. Please refer to the [Split-Brain Protection for ISet and TransactionalSet section](#).

## 7.5.3. Split-Brain Protection for ISet and TransactionalSet

ISet & TransactionalSet can be configured to check for a minimum number of available members before applying queue operations (see [Split-Brain Protection](#)). This is a check to avoid performing successful queue operations on all parts of a cluster during a network partition.

Following is a list of methods that now support Split-Brain Protection checks. The list is grouped by quorum type.

ISet:

- WRITE, READ\_WRITE:
  - `add`
  - `addAll`
  - `clear`
  - `remove`
  - `removeAll`
- READ, READ\_WRITE:
  - `contains`
  - `containsAll`
  - `isEmpty`
  - `iterator`
  - `size`
  - `toArray`

TransactionalSet:

- WRITE, READ\_WRITE:
  - `add`
  - `remove`
- READ, READ\_WRITE:
  - `size`

## Configuring Split-Brain Protection

Split-Brain protection for ISet can be configured programmatically using the method `setQuorumName()`, or declaratively using the element `quorum-ref`. Following is an example declarative configuration:

```
<set name="default">
  ...
  <quorum-ref>quorumname</quorum-ref>
  ...
</set>
```

The value of `quorum-ref` should be the quorum configuration name which you configured under the `quorum` element as explained in the [Split-Brain Protection section](#).

## 7.6. List

Hazelcast List (IList) is similar to Hazelcast Set, but Hazelcast List also allows duplicate elements.

- Besides allowing duplicate elements, Hazelcast List preserves the order of elements.
- Hazelcast List is a non-partitioned data structure where values and each backup are represented by their own single partition.
- Hazelcast List cannot be scaled beyond the capacity of a single machine.
- All items are copied to local and iteration occurs locally.



While IMap and ICache are the recommended data structures to be used by [Hazelcast Jet](#), IList can also be used by it for unit testing or similar non-production situations. Please see [here](#) in the Hazelcast Jet Reference Manual to learn how Jet can use IList, e.g., how it can fill IList with data, consume it in a Jet job and drain the results to another IList. Please also see the [Fast Batch Processing](#) and [Real-Time Stream Processing](#) use cases for Hazelcast Jet.

### 7.6.1. Getting a List and Putting Items

Use the HazelcastInstance `getList` method to get the List, then use the `add` method to put items into the List.

```
HazelcastInstance hz = Hazelcast.newHazelcastInstance();
IList<String> list = hz.getList("list");
list.add("Tokyo");
list.add("Paris");
list.add("London");
list.add("New York");
System.out.println("Putting finished!");
```

Hazelcast List uses `ItemListener` to listen to events that occur when items are added to and removed from the List. Please refer to the [Listening for Item Events section](#) for information on how to create an item listener class and register it.

### 7.6.2. Configuring List

The following are example list configurations.

**Declarative:**

```

<list name="default">
  <backup-count>1</backup-count>
  <async-backup-count>0</async-backup-count>
  <max-size>10</max-size>
  <item-listeners>
    <item-listener>
      com.hazelcast.examples.ItemListener
    </item-listener>
  </item-listeners>
  <quorum-ref>quorumname</quorum-ref>
</list>

```

### Programmatic:

```

Config config = new Config();
CollectionConfig collectionList = config.getListConfig("MyList");
collectionList.setBackupCount(1)
               .setMaxSize(10)
               .setQuorumName("quorumname");

```

List configuration has the following elements.

- **statistics-enabled**: True (default) if statistics gathering is enabled on the list, false otherwise.
- **backup-count**: Number of synchronous backups. List is a non-partitioned data structure, so all entries of a List reside in one partition. When this parameter is '1', there will be one backup of that List in another member in the cluster. When it is '2', two members will have the backup.
- **async-backup-count**: Number of asynchronous backups.
- **max-size**: The maximum number of entries for this List.
- **item-listeners**: Lets you add listeners (listener classes) for the list items. You can also set the attribute **include-value** to **true** if you want the item event to contain the item values. You can set the attribute **local** to **true** if you want to listen the items on the local member.
- **quorum-ref**: Name of quorum configuration that you want this List to use. Please see the [Split-Brain Protection for IList and TransactionalList](#) section.

### 7.6.3. Split-Brain Protection for IList and TransactionalList

IList & TransactionalList can be configured to check for a minimum number of available members before applying queue operations (see [Split-Brain Protection](#)). This is a check to avoid performing successful queue operations on all parts of a cluster during a network partition.

Following is a list of methods that now support Split-Brain Protection checks. The list is grouped by quorum type.

IList:

- WRITE, READ\_WRITE:



- `add`
- `addAll`
- `clear`
- `remove`
- `removeAll`
- `set`
- `READ, READ_WRITE`:
  - `add`
  - `contains`
  - `containsAll`
  - `get`
  - `indexOf`
  - `isEmpty`
  - `iterator`
  - `lastIndexOf`
  - `listIterator`
  - `size`
  - `subList`
  - `toArray`

TransactionalList:

- `WRITE, READ_WRITE`:
  - `add`
  - `remove`
- `READ, READ_WRITE`:
  - `size`

### Configuring Split-Brain Protection

Split-Brain protection for `IList` can be configured programmatically using the method `setQuorumName()`, or declaratively using the element `quorum-ref`. Following is an example declarative configuration:

```
<list name="default">
  ...
  <quorum-ref>quorumname</quorum-ref>
  ...
</list>
```

The value of `quorum-ref` should be the quorum configuration name which you configured under the `quorum` element as explained in the [Split-Brain Protection section](#).

## 7.7. Ringbuffer

Hazelcast Ringbuffer is a replicated but not partitioned data structure that stores its data in a ring-like structure. You can think of it as a circular array with a given capacity. Each Ringbuffer has a tail and a head. The tail is where the items are added and the head is where the items are overwritten or expired. You can reach each element in a Ringbuffer using a sequence ID, which is mapped to the elements between the head and tail (inclusive) of the Ringbuffer.

### 7.7.1. Getting a Ringbuffer and Reading Items

Reading from Ringbuffer is simple: get the Ringbuffer with the HazelcastInstance `getRingbuffer` method, get its current head with the `headSequence` method and start reading. Use the method `readOne` to return the item at the given sequence; `readOne` blocks if no item is available. To read the next item, increment the sequence by one.

```
HazelcastInstance hz = Hazelcast.newHazelcastInstance();
Ringbuffer<String> ringbuffer = hz.getRingbuffer("rb");
long sequence = ringbuffer.headSequence();
while(true){
    String item = ringbuffer.readOne(sequence);
    sequence++;
    // process item
}
```

By exposing the sequence, you can now move the item from the Ringbuffer as long as the item is still available. If the item is not available any longer, `StaleSequenceException` is thrown.

### 7.7.2. Adding Items to a Ringbuffer

Adding an item to a Ringbuffer is also easy with the Ringbuffer `add` method:

```
Ringbuffer<String> ringbuffer = hz.getRingbuffer("SampleRB");
ringbuffer.add("someitem");
```

Use the method `add` to return the sequence of the inserted item; the sequence value will always be unique. You can use this as a very cheap way of generating unique IDs if you are already using Ringbuffer.

### 7.7.3. IQueue vs. Ringbuffer

Hazelcast Ringbuffer can sometimes be a better alternative than an Hazelcast IQueue. Unlike IQueue, Ringbuffer does not remove the items, it only reads items using a certain position. There are many advantages to this approach:

- The same item can be read multiple times by the same thread. This is useful for realizing semantics of read-at-least-once or read-at-most-once.

- The same item can be read by multiple threads. Normally you could use an IQueue per thread for the same semantic, but this is less efficient because of the increased remoting. A take from an IQueue is destructive, so the change needs to be applied for backup also, which is why a `queue.take()` is more expensive than a `ringBuffer.read(...)`.
- Reads are extremely cheap since there is no change in the Ringbuffer. Therefore no replication is required.
- Reads and writes can be batched to speed up performance. Batching can dramatically improve the performance of Ringbuffer.

#### 7.7.4. Configuring Ringbuffer Capacity

By default, a Ringbuffer is configured with a `capacity` of 10000 items. This creates an array with a size of 10000. If a `time-to-live` is configured, then an array of longs is also created that stores the expiration time for every item. In a lot of cases you may want to change this `capacity` number to something that better fits your needs.

Below is a declarative configuration example of a Ringbuffer with a `capacity` of 2000 items.

```
<ringbuffer name="rb">
  <capacity>2000</capacity>
</ringbuffer>
```

Currently, Hazelcast Ringbuffer is not a partitioned data structure; its data is stored in a single partition and the replicas are stored in another partition. Therefore, create a Ringbuffer that can safely fit in a single cluster member.

#### 7.7.5. Backing Up Ringbuffer

Hazelcast Ringbuffer has a single synchronous backup by default. You can control the Ringbuffer backup just like most of the other Hazelcast distributed data structures by setting the synchronous and asynchronous backups: `backup-count` and `async-backup-count`. In the example below, a Ringbuffer is configured with no synchronous backups and one asynchronous backup:

```
<ringbuffer name="rb">
  <backup-count>0</backup-count>
  <async-backup-count>1</async-backup-count>
</ringbuffer>
```

An asynchronous backup will probably give you better performance. However, there is a chance that the item added will be lost when the member owning the primary crashes before the backup could complete. You may want to consider batching methods if you need high performance but do not want to give up on consistency.

#### 7.7.6. Configuring Ringbuffer Time-To-Live

You can configure Hazelcast Ringbuffer with a time-to-live in seconds. Using this setting, you can

control how long the items remain in the Ringbuffer before they are expired. By default, the time-to-live is set to 0, meaning that unless the item is overwritten, it will remain in the Ringbuffer indefinitely. If you set a time-to-live and an item is added, then, depending on the Overflow Policy, either the oldest item is overwritten, or the call is rejected.

In the example below, a Ringbuffer is configured with a time-to-live of 180 seconds.

```
<ringbuffer name="rb">
  <time-to-live-seconds>180</time-to-live-seconds>
</ringbuffer>
```

### 7.7.7. Setting Ringbuffer Overflow Policy

Using the overflow policy, you can determine what to do if the oldest item in the Ringbuffer is not old enough to expire when more items than the configured Ringbuffer capacity are being added. The below options are currently available.

- **OverflowPolicy.OVERWRITE**: The oldest item is overwritten.
- **OverflowPolicy.FAIL**: The call is aborted. The methods that make use of the OverflowPolicy return `-1` to indicate that adding the item has failed.

Overflow policy gives you fine control on what to do if the Ringbuffer is full. You can also use the overflow policy to apply a back pressure mechanism. The following example code shows the usage of an exponential backoff.

```
Random random = new Random();
HazelcastInstance hz = Hazelcast.newHazelcastInstance();
Ringbuffer<Long> rb = hz.getRingbuffer("rb");

long i = 100;
while (true) {
    long sleepMs = 100;
    for (; ; ) {
        long result = rb.addAsync(i, OverflowPolicy.FAIL).get();
        if (result != -1) {
            break;
        }
        TimeUnit.MILLISECONDS.sleep(sleepMs);
        sleepMs = min(5000, sleepMs * 2);
    }

    // add a bit of random delay to make it look a bit more realistic
    Thread.sleep(random.nextInt(10));

    System.out.println("Written: " + i);
    i++;
}
```

## 7.7.8. Ringbuffer with Persistent Datastore

Hazelcast allows you to load and store the Ringbuffer items from/to a persistent datastore using the interface `RingbufferStore`. If a Ringbuffer store is enabled, each item added to the Ringbuffer will also be stored at the configured Ringbuffer store.

If the Ringbuffer store is configured, you can get items with sequences which are no longer in the actual Ringbuffer but are only in the Ringbuffer store. This will probably be much slower but still allow you to continue consuming items from the Ringbuffer even if they are overwritten with newer items in the Ringbuffer.

When a Ringbuffer is being instantiated, it will check if the Ringbuffer store is configured and will request the latest sequence in the Ringbuffer store. This is to enable the Ringbuffer to start with sequences larger than the ones in the Ringbuffer store. In this case, the Ringbuffer is empty but you can still request older items from it (which will be loaded from the Ringbuffer store).

The Ringbuffer store will store items in the same format as the Ringbuffer. If the `BINARY` in-memory format is used, the Ringbuffer store must implement the interface `RingbufferStore<byte[]>` meaning that the Ringbuffer will receive items in the binary format. If the `OBJECT` in-memory format is used, the Ringbuffer store must implement the interface `RingbufferStore<K>`, where `K` is the type of item being stored (meaning that the Ringbuffer store will receive the deserialized object).

When adding items to the Ringbuffer, the method `storeAll` allows you to store items in batches.

The following example class includes all of the `RingbufferStore` methods.

```

public class TheRingbufferObjectStore implements RingbufferStore<Item> {

    @Override
    public void store(long sequence, Item data) {
        System.out.println("Object store");
    }

    @Override
    public void storeAll(long firstItemSequence, Item[] items) {
        System.out.println("Object store all");
    }

    @Override
    public Item load(long sequence) {
        System.out.println("Object load");
        return null;
    }

    @Override
    public long getLargestSequence() {
        System.out.println("Object get largest sequence");
        return -1;
    }
}

```

**Item** must be serializable. The following is an example of a Ringbuffer with the Ringbuffer store configured and enabled.

```

<ringbuffer name="default">
  <capacity>10000</capacity>
  <time-to-live-seconds>30</time-to-live-seconds>
  <backup-count>1</backup-count>
  <async-backup-count>0</async-backup-count>
  <in-memory-format>BINARY</in-memory-format>
  <ringbuffer-store>
    <class-name>com.hazelcast.RingbufferStoreImpl</class-name>
  </ringbuffer-store>
</ringbuffer>

```

Below are the explanations for the Ringbuffer store configuration elements:

- **class-name**: Name of the class implementing the `RingbufferStore` interface.
- **factory-class-name**: Name of the class implementing the `RingbufferStoreFactory` interface. This interface allows a factory class to be registered instead of a class implementing the `RingbufferStore` interface.

Either the **class-name** or the **factory-class-name** element should be used.

## 7.7.9. Configuring Ringbuffer In-Memory Format

You can configure Hazelcast Ringbuffer with an in-memory format that controls the format of the Ringbuffer's stored items. By default, **BINARY** in-memory format is used, meaning that the object is stored in a serialized form. You can select the **OBJECT** in-memory format, which is useful when filtering is applied or when the **OBJECT** in-memory format has a smaller memory footprint than **BINARY**.

In the declarative configuration example below, a Ringbuffer is configured with the **OBJECT** in-memory format:

```
<ringbuffer name="rb">
  <in-memory-format>OBJECT</in-memory-format>
</ringbuffer>
```

## 7.7.10. Configuring Split-Brain Protection for Ringbuffer

Ringbuffer can be configured to check for a minimum number of available members before applying Ringbuffer operations. This is a check to avoid performing successful Ringbuffer operations on all parts of a cluster during a network partition and can be configured using the element **quorum-ref**. You should set this element's value as the quorum's name, which you configured under the **quorum** element as explained in the [Split-Brain Protection section](#). Following is an example snippet:

```
<ringbuffer name="rb">
  <quorum-ref>quorumname</quorum-ref>
</ringbuffer>
```

Following is a list of methods that now support Split-Brain Protection checks. The list is grouped by quorum type.

- WRITE, READ\_WRITE:
  - **add**
  - **addAllAsync**
  - **addAsync**
- READ, READ\_WRITE:
  - **capacity**
  - **headSequence**
  - **readManyAsync**
  - **readOne**
  - **remainingCapacity**
  - **size**
  - **tailSequence**

### 7.7.11. Adding Batched Items

In the previous examples, the method `ringBuffer.add()` is used to add an item to the Ringbuffer. The problems with this method are that it always overwrites and that it does not support batching. Batching can have a huge impact on the performance. You can use the method `addAllAsync` to support batching.

Please see the following example code.

```
List<String> items = Arrays.asList("1","2","3");
ICompletableFuture<Long> f = rb.addAllAsync(items, OverflowPolicy.OVERWRITE);
f.get();
```

In the above case, three strings are added to the Ringbuffer using the policy `OverflowPolicy.OVERWRITE`. Please see the [Overflow Policy section](#) for more information.

### 7.7.12. Reading Batched Items

In the previous example, the `readOne` method read items from the Ringbuffer. `readOne` is simple but not very efficient for the following reasons:

- `readOne` does not use batching.
- `readOne` cannot filter items at the source; the items need to be retrieved before being filtered.

The method `readManyAsync` can read a batch of items and can filter items at the source.

Please see the following example code.

```
ICompletableFuture<ReadResultSet<E>> readManyAsync(
    long startSequence,
    int minCount,
    int maxCount,
    IFunction<E, Boolean> filter);
```

The meanings of the `readManyAsync` arguments are given below.

- `startSequence`: Sequence of the first item to read.
- `minCount`: Minimum number of items to read. If you do not want to block, set it to 0. If you want to block for at least one item, set it to 1.
- `maxCount`: Maximum number of the items to retrieve. Its value cannot exceed 1000.
- `filter`: A function that accepts an item and checks if it should be returned. If no filtering should be applied, set it to null.

A full example is given below.



```

long sequence = rb.headSequence();
for(;;) {
    ICompletableFuture<ReadResultSet<String>> f = rb.readManyAsync(sequence, 1, 10,
null);
    ReadResultSet<String> rs = f.get();
    for (String s : rs) {
        System.out.println(s);
    }
    sequence+=rs.readCount();
}

```

Please take a careful look at how your sequence is being incremented. You cannot always rely on the number of items being returned if the items are filtered out.

There is not any filtering applied in the above example. The following example shows how you can apply a filter when reading batched items. First, let's create our filter as shown below:

```

public class FruitFilter implements IFunction<String, Boolean> {
    public FruitFilter() {}

    public Boolean apply(String s) {
        return s.startsWith("a");
    }
}

```

So, the `FruitFilter` checks whether a `String` object starts with the letter "a". You can see this filter in action in the below example:

```

HazelcastInstance hz = Hazelcast.newHazelcastInstance();
Ringbuffer<String> rb = hz.getRingbuffer("rb");

rb.add("apple");
rb.add("orange");
rb.add("pear");
rb.add("peach");
rb.add("avocado");

long sequence = rb.headSequence();
CompletableFuture<ReadResultSet<String>> f = rb.readManyAsync(sequence, 2, 5, new
FruitFilter());

try {
    ReadResultSet<String> rs = f.get();
    for (String s : rs) {
        System.out.println(s);
    }
}
catch (InterruptedException | ExecutionException e) {
    System.out.println(e.getMessage());
}

```

### 7.7.13. Using Async Methods

Hazelcast Ringbuffer provides asynchronous methods for more powerful operations like batched writing or batched reading with filtering. To make these methods synchronous, just call the method `get()` on the returned future.

Please see the following example code.

```

CompletableFuture f = ringbuffer.addAsync(item, OverflowPolicy.FAIL);
f.get();

```

However, you can also use `CompletableFuture` to get notified when the operation has completed. The advantage of `CompletableFuture` is that the thread used for the call is not blocked till the response is returned.

Please see the below code as an example of when you want to get notified when a batch of reads has completed.

```

CompletableFuture<ReadResultSet<String>> f = rb.readManyAsync(sequence, min, max,
someFilter);
f.andThen(new ExecutionCallback<ReadResultSet<String>>() {
    @Override
    public void onResponse(ReadResultSet<String> response) {
        for (String s : response) {
            System.out.println("Received:" + s);
        }
    }
})

@Override
public void onFailure(Throwable t) {
    t.printStackTrace();
}
});

```

### 7.7.14. Ringbuffer Configuration Examples

The following shows the declarative configuration of a Ringbuffer called `rb`. The configuration is modeled after the Ringbuffer defaults.

```

<ringbuffer name="rb">
  <capacity>10000</capacity>
  <backup-count>1</backup-count>
  <async-backup-count>0</async-backup-count>
  <time-to-live-seconds>0</time-to-live-seconds>
  <in-memory-format>BINARY</in-memory-format>
  <quorum-ref>quorumname</quorum-ref>
</ringbuffer>

```

You can also configure a Ringbuffer programmatically. The following is a programmatic version of the above declarative configuration.

```

Config config = new Config();
RingbufferConfig rbConfig = config.getRingbufferConfig("myRB");
rbConfig.setCapacity(10000)
        .setBackupCount(1)
        .setAsyncBackupCount(0)
        .setTimeToLiveSeconds(0)
        .setInMemoryFormat(InMemoryFormat.BINARY)
        .setQuorumName("quorumname");

```

## 7.8. Topic

Hazelcast provides a distribution mechanism for publishing messages that are delivered to multiple subscribers. This is also known as a publish/subscribe (pub/sub) messaging model. Publishing and

subscribing operations are cluster wide. When a member subscribes to a topic, it is actually registering for messages published by any member in the cluster, including the new members that joined after you add the listener.



Publish operation is async. It does not wait for operations to run in remote members; it works as fire and forget.

### 7.8.1. Getting a Topic and Publishing Messages

Use the `HazelcastInstance`'s `getTopic` method to get the topic, then use the topic's `publish` method to publish your messages. The following is a sample publisher:

```
public class TopicPublisher {

    public static void main(String[] args) {

        HazelcastInstance hz = Hazelcast.newHazelcastInstance();
        ITopic<Date> topic = hz.getTopic("topic");
        topic.publish(new Date());
    }
}
```

And here is a sample subscriber:

```
public class TopicSubscriber {

    public static void main(String[] args) {
        HazelcastInstance hz = Hazelcast.newHazelcastInstance();
        ITopic<Date> topic = hz.getTopic("topic");
        topic.addMessageListener(new MessageListenerImpl());
        System.out.println("Subscribed");
    }

    private static class MessageListenerImpl implements MessageListener<Date> {
        public void onMessage(Message<Date> m) {
            System.out.println("Received: " + m.getMessageObject());
        }
    }
}
```

Hazelcast Topic uses the `MessageListener` interface to listen for events that occur when a message is received. Please refer to the [Listening for Topic Messages section](#) for information on how to create a message listener class and register it.

### 7.8.2. Getting Topic Statistics

Topic has two statistic variables that you can query. These values are incremental and local to the

member.

```
HazelcastInstance hazelcastInstance = Hazelcast.newHazelcastInstance();
ITopic<Object> myTopic = hazelcastInstance.getTopic( "myTopicName" );

myTopic.getLocalTopicStats().getPublishOperationCount();
myTopic.getLocalTopicStats().getReceiveOperationCount();
```

`getPublishOperationCount` and `getReceiveOperationCount` returns the total number of published and received messages since the start of this member, respectively. Please note that these values are not backed up, so if the member goes down, these values will be lost.

You can disable this feature with topic configuration. Please see the [Configuring Topic section](#).



These statistics values can be also viewed in Management Center. Please see the [Monitoring Topics section](#) in Hazelcast Management Center Reference Manual.

### 7.8.3. Understanding Topic Behavior

Each cluster member has a list of all registrations in the cluster. When a new member is registered for a topic, it sends a registration message to all members in the cluster. Also, when a new member joins the cluster, it will receive all registrations made so far in the cluster.

The behavior of a topic varies depending on the value of the configuration parameter `globalOrderEnabled`.

#### Ordering Messages as Published

If `globalOrderEnabled` is disabled, messages are not ordered and listeners (subscribers) process the messages in the order that the messages are published. If cluster member **M** publishes messages **m1**, **m2**, **m3**, ..., **mn** to a topic **T**, then Hazelcast makes sure that all of the subscribers of topic **T** will receive and process **m1**, **m2**, **m3**, ..., **mn** in the given order.

Here is how it works. Let's say that we have three members (**member1**, **member2** and **member3**) and that **member1** and **member2** are registered to a topic named **news**. Note that all three members know that **member1** and **member2** are registered to **news**.

In this example, **member1** publishes two messages: **a1** and **a2**. **Member3** publishes two messages: **c1** and **c2**. When **member1** and **member3** publish a message, they will check their local list for registered members, they will discover that **member1** and **member2** are in their lists, and then they will fire messages to those members. One possible order of the messages received could be the following.

**member1** → **c1**, **a1**, **a2**, **c2**

**member2** → **c1**, **c2**, **a1**, **a2**

## Ordering Messages for Members

If `globalOrderEnabled` is enabled, all members listening to the same topic will get its messages in the same order.

Here is how it works. Let's say that we have three members (**member1**, **member2** and **member3**) and that **member1** and **member2** are registered to a topic named `news`. Note that all three members know that **member1** and **member2** are registered to `news`.

In this example, **member1** publishes two messages: `a1` and `a2`. **Member3** publishes two messages: `c1` and `c2`. When a member publishes messages over the topic `news`, it first calculates which partition the `news` ID corresponds to. Then it sends an operation to the owner of the partition for that member to publish messages. Let's assume that `news` corresponds to a partition that **member2** owns. **member1** and **member3** first sends all messages to **member2**. Assume that the messages are published in the following order:

**member1** → `a1, c1, a2, c2`

**member2** then publishes these messages by looking at registrations in its local list. It sends these messages to **member1** and **member2** (it makes a local dispatch for itself).

**member1** → `a1, c1, a2, c2`

**member2** → `a1, c1, a2, c2`

This way we guarantee that all members will see the events in the same order.

## Keeping Generated and Published Order the Same

In both cases, there is a `StripedExecutor` in `EventService` that is responsible for dispatching the received message. For all events in Hazelcast, the order that events are generated and the order they are published to the user are guaranteed to be the same via this `StripedExecutor`.

In `StripedExecutor`, there are as many threads as are specified in the property `hazelcast.event.thread.count` (default is five). For a specific event source (for a particular topic name), `hash of that source's name % 5` gives the ID of the responsible thread. Note that there can be another event source (entry listener of a map, item listener of a collection, etc.) corresponding to the same thread. In order not to make other messages to block, heavy processing should not be done in this thread. If there is time-consuming work that needs to be done, the work should be handed over to another thread. Please see the [Getting a Topic and Publishing Messages section](#).

### 7.8.4. Configuring Topic

To configure a topic, set the topic name, decide on statistics and global ordering, and set message listeners. Default values are:

- `global-ordering` is **false**, meaning that by default, there is no guarantee of global order.
- `statistics` is **true**, meaning that by default, statistics are calculated.

You can see the example configuration snippets below.

## Declarative:

```
<hazelcast>
  ...
  <topic name="yourTopicName">
    <global-ordering-enabled>true</global-ordering-enabled>
    <statistics-enabled>true</statistics-enabled>
    <message-listeners>
      <message-listener>MessageListenerImpl</message-listener>
    </message-listeners>
  </topic>
  ...
</hazelcast>
```

## Programmatic:

```
TopicConfig topicConfig = new TopicConfig();
topicConfig.setGlobalOrderingEnabled( true );
topicConfig.setStatisticsEnabled( true );
topicConfig.setName( "yourTopicName" );
MessageListener<String> implementation = new MessageListener<String>() {
    @Override
    public void onMessage( Message<String> message ) {
        // process the message
    }
};
topicConfig.addMessageListenerConfig( new ListenerConfig( implementation ) );
HazelcastInstance instance = Hazelcast.newHazelcastInstance();
```

Topic configuration has the following elements.

- **statistics-enabled**: Default is **true**, meaning statistics are calculated.
- **global-ordering-enabled**: Default is **false**, meaning there is no global order guarantee.
- **message-listeners**: Lets you add listeners (listener classes) for the topic messages.

Besides the above elements, there are the following system properties that are topic related but not topic specific:

- **hazelcast.event.queue.capacity** with a default value of 1,000,000
- **hazelcast.event.queue.timeout.millis** with a default value of 250
- **hazelcast.event.thread.count** with a default value of 5

For a description of these parameters, please see the [Global Event Configuration section](#).

## 7.9. Reliable Topic

Reliable Topic uses the same `ITopic` interface as a regular topic. The main difference is that Reliable Topic is backed up by the Ringbuffer data structure. The following are the advantages of this approach:

- Events are not lost since the Ringbuffer is configured with one synchronous backup by default.
- Each Reliable `ITopic` gets its own Ringbuffer; if a topic has a very fast producer, it will not lead to problems at topics that run at a slower pace.
- Since the event system behind a regular `ITopic` is shared with other data structures, e.g., collection listeners, you can run into isolation problems. This does not happen with the Reliable `ITopic`.

Here is a sample code snippet for a publisher using Reliable Topic:

```
public class PublisherMember {
    public static void main(String[] args) {
        HazelcastInstance hz = Hazelcast.newHazelcastInstance();
        Random random = new Random();
        ITopic<Long> topic = hz.getReliableTopic("sometopic");
        long messageId = 0;

        while (true) {
            topic.publish(messageId);
            messageId++;
            System.out.println("Written: " + messageId);
            sleepMillis(random.nextInt(100));
        }
    }

    public static boolean sleepMillis(int millis) {
        try {
            MILLISECONDS.sleep(millis);
        } catch (InterruptedException e) {
            Thread.currentThread().interrupt();
            return false;
        }
        return true;
    }
}
```

And the following is a sample code snippet for the subscriber:



```

public class SubscribedMember {

    public static void main(String[] args) {
        HazelcastInstance hz = Hazelcast.newHazelcastInstance();
        ITopic<Long> topic = hz.getReliableTopic("sometopic");
        topic.addMessageListener(new MessageListenerImpl());
    }

    private static class MessageListenerImpl implements MessageListener<Long> {
        public void onMessage(Message<Long> m) {
            System.out.println("Received: " + m.getMessageObject());
        }
    }
}

```

When you create a Reliable Topic, Hazelcast automatically creates a Ringbuffer for it. You may configure this Ringbuffer by adding a Ringbuffer config with the same name as the Reliable Topic. For instance, if you have a Reliable Topic with the name "sometopic", you should add a Ringbuffer config with the name "sometopic" to configure the backing Ringbuffer. Some of the things that you may configure is the capacity, the time-to-live for the topic messages and you can even add a Ringbuffer store which will allow you to have a persistent topic. By default, a Ringbuffer does not have any TTL (time-to-live) and it has a limited capacity; you may want to change that configuration. The following is an example configuration for the "sometopic" given above.

```

<hazelcast>

    <!-- This is the ringbuffer that is used by the 'sometopic' Reliable-topic. As you
    can see the
        ringbuffer has the same name as the topic. -->
    <ringbuffer name="sometopic">
        <capacity>1000</capacity>
        <time-to-live-seconds>5</time-to-live-seconds>
    </ringbuffer>

    <reliable-topic name="sometopic">
        <topic-overload-policy>BLOCK</topic-overload-policy>
    </reliable-topic>
</hazelcast>

```

Please see the [Configuring Reliable Topic section](#) below for the descriptions of all Reliable Topic configuration elements.

By default, the Reliable `ITopic` uses a shared thread pool. If you need a better isolation, you can configure a custom executor on the `ReliableTopicConfig`.

Because the reads on a Ringbuffer are not destructive, batching is easy to apply. `ITopic` uses read batching and reads ten items at a time (if available) by default. See [Reading Batched Items](#) for more information.

## 7.9.1. Slow Consumers

The Reliable `ITopic` provides control and a way to deal with slow consumers. It is unwise to keep events for a slow consumer in memory indefinitely since you do not know when the slow consumer is going to catch up. You can control the size of the Ringbuffer by using its capacity. For the cases when a Ringbuffer runs out of its capacity, you can specify the following policies for the `TopicOverloadPolicy` configuration:

- `DISCARD_OLDEST`: Overwrite the oldest item, even if a TTL is set. In this case the fast producer supersedes a slow consumer.
- `DISCARD_NEWEST`: Discard the newest item.
- `BLOCK`: Wait until the items are expired in the Ringbuffer.
- `ERROR`: Immediately throw `TopicOverloadException` if there is no space in the Ringbuffer.

## 7.9.2. Configuring Reliable Topic

The following are example Reliable Topic configurations.

### Declarative:

```
<reliable-topic name="default">
  <statistics-enabled>true</statistics-enabled>
  <message-listeners>
    <message-listener>
      ...
    </message-listener>
  </message-listeners>
  <read-batch-size>10</read-batch-size>
  <topic-overload-policy>BLOCK</topic-overload-policy>
</reliable-topic>
```

### Programmatic:

```
Config config = new Config();
ReliableTopicConfig rtConfig = config.getReliableTopicConfig( "default" );
rtConfig.setTopicOverloadPolicy( TopicOverloadPolicy.BLOCK )
        .setReadBatchSize( 10 )
        .setStatisticsEnabled( true );
```

Reliable Topic configuration has the following elements.

- `statistics-enabled`: Enables or disables the statistics collection for the Reliable Topic. Its default value is `true`.
- `message-listener`: Message listener class that listens to the messages when they are added or removed.
- `read-batch-size`: Minimum number of messages that Reliable Topic will try to read in batches.

Its default value is 10.

- **topic-overload-policy**: Policy to handle an overloaded topic. Available values are **DISCARD\_OLDEST**, **DISCARD\_NEWEST**, **BLOCK** and **ERROR**. Its default value is **BLOCK**. See [Slow Consumers](#) for definitions of these policies.

## 7.10. Lock

ILock is the distributed implementation of `java.util.concurrent.locks.Lock`, meaning that if you lock using an ILock, the critical section that it guards is guaranteed to be executed by only one thread in the entire cluster, provided that there are no network failures. Even though locks are great for synchronization, they can lead to problems if not used properly. Also note that Hazelcast Lock does not support fairness.

### 7.10.1. Using Try-Catch Blocks with Locks

Always use locks with **try-catch** blocks. This will ensure that locks are released if an exception is thrown from the code in a critical section. Also note that the `lock` method is outside the **try-catch** block because we do not want to unlock if the lock operation itself fails.

```
HazelcastInstance hazelcastInstance = Hazelcast.newHazelcastInstance();
Lock lock = hazelcastInstance.getLock( "myLock" );
lock.lock();
try {
    // do something here
} finally {
    lock.unlock();
}
```

### 7.10.2. Releasing Locks with tryLock Timeout

If a lock is not released in the cluster, another thread that is trying to get the lock can wait forever. To avoid this, use `tryLock` with a timeout value. You can set a high value (normally it should not take that long) for `tryLock`. You can check the return value of `tryLock` as follows:

```
if ( lock.tryLock ( 10, TimeUnit.SECONDS ) ) {
    try {
        // do some stuff here..
    } finally {
        lock.unlock();
    }
} else {
    // warning
}
```

### 7.10.3. Avoiding Waiting Threads with Lease Time

You can also avoid indefinitely waiting threads by using lock with lease time - the lock will be released in the given lease time. The lock can be safely unlocked before the lease time expires. Note that the unlock operation can throw an `IllegalMonitorStateException` if the lock is released because the lease time expires. If that is the case, critical section guarantee is broken.

Please see the below example.

```
lock.lock( 5, TimeUnit.SECONDS )
try {
    // do some stuff here..
} finally {
    try {
        lock.unlock();
    } catch ( IllegalMonitorStateException ex ){
        // WARNING Critical section guarantee can be broken
    }
}
```

You can also specify a lease time when trying to acquire a lock: `tryLock(time, unit, leaseTime, leaseUnit)`. In that case, it tries to acquire the lock within the specified lease time. If the lock is not available, the current thread becomes disabled for thread scheduling purposes until either it acquires the lock or the specified waiting time elapses. Note that this lease time cannot be longer than the time you specify with the system property `hazelcast.lock.max.lease.time.seconds`. Please see the [System Properties appendix](#) to see the description of this property and to learn how to set a system property.

### 7.10.4. Understanding Lock Behavior

- Locks are fail-safe. If a member holds a lock and some other members go down, the cluster will keep your locks safe and available. Moreover, when a member leaves the cluster, all the locks acquired by that dead member will be removed so that those locks are immediately available for live members.
- Locks are re-entrant. The same thread can lock multiple times on the same lock. Note that for other threads to be able to require this lock, the owner of the lock must call `unlock` as many times as the owner called `lock`.
- In the split-brain scenario, the cluster behaves as if it were two different clusters. Since two separate clusters are not aware of each other, two members from different clusters can acquire the same lock. For more information on places where split-brain syndrome can be handled, please see [Split-Brain syndrome](#).
- Locks are not automatically removed. If a lock is not used anymore, Hazelcast will not automatically garbage collect the lock. This can lead to an `OutOfMemoryError`. If you create locks on the fly, make sure they are destroyed.
- Hazelcast `IMap` also provides locking support on the entry level with the method `IMap.lock(key)`. Although the same infrastructure is used, `IMap.lock(key)` is not an `ILock` and it is

not possible to expose it directly.

## ILock vs. IMap.lock

ILock-based locks use system resources even when they are not acquired. You have to call `destroy()`, but this can have a side effect when another thread is trying to acquire it. ILock-based lock is a good choice when you have a limited number of locks. The IMap-based locks are auto-destructed. They use no resources when they are not acquired. This implies they are invisible for monitoring unless they are being hold by some thread.

### 7.10.5. Synchronizing Threads with ICondition

`ICondition` is the distributed implementation of the `notify`, `notifyAll` and `wait` operations on the Java object. You can use it to synchronize threads across the cluster. More specifically, you use `ICondition` when a thread's work depends on another thread's output. A good example is producer/consumer methodology.

Please see the below code examples for a producer/consumer implementation.

#### Producer thread:

```
HazelcastInstance hazelcastInstance = Hazelcast.newHazelcastInstance();
Lock lock = hazelcastInstance.getLock( "myLockId" );
ICondition condition = lock.newCondition( "myConditionId" );

lock.lock();
try {
    while ( !shouldProduce() ) {
        condition.await(); // frees the lock and waits for signal
                          // when it wakes up it re-acquires the lock
                          // if available or waits for it to become
                          // available
    }
    produce();
    condition.signalAll();
} finally {
    lock.unlock();
}
```



The method `await()` takes time value and time unit as arguments. If you specify a negative value for the time, it is interpreted as infinite.

#### Consumer thread:

```

HazelcastInstance hazelcastInstance = Hazelcast.newHazelcastInstance();
Lock lock = hazelcastInstance.getLock( "myLockId" );
ICondition condition = lock.newCondition( "myConditionId" );

lock.lock();
try {
    while ( !canConsume() ) {
        condition.await(); // frees the lock and waits for signal
                           // when it wakes up it re-acquires the lock if
                           // available or waits for it to become
                           // available
    }
    consume();
    condition.signalAll();
} finally {
    lock.unlock();
}

```

### 7.10.6. Split-Brain Protection for Lock

Locks can be configured to check for a minimum number of available members before applying lock operations (see [Split-Brain Protection](#)). This is a check to avoid performing successful lock operations on all parts of a cluster during a network partition. Due to the implementation details, the check does not guarantee that the lock will fail in all conditions of a network partition and it can happen that two members can acquire the same lock.

Once the membership change has been detected, the lock operations will fail with a [QuorumException](#) if enough size of members are not present. In essence, this does not provide correctness but rather narrows down the window of opportunity in which locks can continue operations on several members concurrently.

Although the check does not provide correctness it can still be useful. In cases where members acquire the lock to perform some costly but idempotent operation, configuring lock quorum can further prevent some cases where the cluster has been split into several sub-clusters and more than one member perform the same operation.

Following is a list of methods that now support quorum checks. The list is grouped by quorum type. Additionally, since Hazelcast IMap also provides locking support, certain map and multimap methods also allow quorum checks.

- WRITE, READ\_WRITE
  - [Condition.await\(\)](#), [Condition.awaitUninterruptibly\(\)](#), [Condition.awaitNanos\(\)](#), [Condition.awaitUntil\(\)](#)
  - [Lock.lockInterruptibly\(\)](#), [ILock.lock\(\)](#), [IMap.tryLock\(\)](#), [IMap.lock\(\)](#), [MultiMap.lock\(\)](#), [MultiMap.tryLock\(\)](#)
  - [Condition.signal\(\)](#), [Condition.signalAll\(\)](#)
- READ, READ\_WRITE

- `ILock.getLockCount()`
- `ILock.getRemainingLeaseTime()`
- `ILock.isLocked()`, `IMap.isLocked()`, `MultiMap.isLocked()`
- `ILock.forceUnlock()`, `IMap.forceUnlock()`, `MultiMap.forceUnlock()`, `ILock.unlock()`, `IMap.unlock()`, `ObjectMultiMapProxy.unlock()`

### 7.10.7. Lock Configuration

As mentioned in the [Split-brain Protection for Lock section](#), Lock allows for split-brain protection.

An example of declarative configuration is as follows:

```
<lock name="myLock">
  <quorum-ref>quorum-name</quorum-ref>
</lock>
```

- `quorum-ref` : Name of quorum configuration that you want this lock to use.

An example of programmatic configuration is as follows:

```
Config config = new Config();
LockConfig lockConfig = new LockConfig();
lockConfig.setName("myLock")
    .setQuorumName("quorum-name");
config.addLockConfig(lockConfig);
```



As mentioned above, a quorum definition for a lock that has the same name or a pattern that matches a map name will force the map locking actions to use the defined quorum. It is important to keep this in mind when using lock quorum and map locking actions.

## 7.11. IAtomicLong

Hazelcast `IAtomicLong` is the distributed implementation of `java.util.concurrent.atomic.AtomicLong`. It offers most of `AtomicLong`'s operations such as `get`, `set`, `getAndSet`, `compareAndSet` and `incrementAndGet`. Since `IAtomicLong` is a distributed implementation, these operations involve remote calls and thus their performances differ from `AtomicLong`.

The following example code creates an instance, increments it by a million and prints the count.

```

HazelcastInstance hazelcastInstance = Hazelcast.newHazelcastInstance();
IAAtomicLong counter = hazelcastInstance.getAtomicLong( "counter" );
for ( int k = 0; k < 1000 * 1000; k++ ) {
    if ( k % 500000 == 0 ) {
        System.out.println( "At: " + k );
    }
    counter.incrementAndGet();
}
System.out.printf( "Count is %s\n", counter.get() );

```

When you start other instances with the code above, you will see the count as **member count** times **a million**.

### 7.11.1. Sending Functions to IAAtomicLong

You can send functions to an IAAtomicLong. **IFunction** is a Hazelcast owned, single method interface. The following sample **IFunction** implementation adds two to the original value.

```

private static class Add2Function implements IFunction<Long, Long> {
    @Override
    public Long apply( Long input ) {
        return input + 2;
    }
}

```

### 7.11.2. Executing Functions on IAAtomicLong

You can use the following methods to execute functions on IAAtomicLong.

- **apply**: Applies the function to the value in IAAtomicLong without changing the actual value and returning the result.
- **alter**: Alters the value stored in the IAAtomicLong by applying the function. It will not send back a result.
- **alterAndGet**: Alters the value stored in the IAAtomicLong by applying the function, storing the result in the IAAtomicLong and returning the result.
- **getAndAlter**: Alters the value stored in the IAAtomicLong by applying the function and returning the original value.

The following sample code includes these methods.



```

HazelcastInstance hazelcastInstance = Hazelcast.newHazelcastInstance();
IAAtomicLong atomicLong = hazelcastInstance.getAtomicLong( "counter" );

atomicLong.set( 1 );
long result = atomicLong.apply( new Add2Function() );
System.out.println( "apply.result: " + result);
System.out.println( "apply.value: " + atomicLong.get() );

atomicLong.set( 1 );
atomicLong.alter( new Add2Function() );
System.out.println( "alter.value: " + atomicLong.get() );

atomicLong.set( 1 );
result = atomicLong.alterAndGet( new Add2Function() );
System.out.println( "alterAndGet.result: " + result );
System.out.println( "alterAndGet.value: " + atomicLong.get() );

atomicLong.set( 1 );
result = atomicLong.getAndAlter( new Add2Function() );
System.out.println( "getAndAlter.result: " + result );
System.out.println( "getAndAlter.value: " + atomicLong.get() );

```

The output of the above class when run is as follows:

```

apply.result: 3
apply.value: 1
alter.value: 3
alterAndGet.result: 3
alterAndGet.value: 3
getAndAlter.result: 1
getAndAlter.value: 3

```

### 7.11.3. Reasons to Use Functions with IAAtomic

The reason for using a function instead of a simple code line like `atomicLong.set(atomicLong.get() + 2)`; is that the IAAtomicLong read and write operations are not atomic. Since IAAtomicLong is a distributed implementation, those operations can be remote ones, which may lead to race problems. By using functions, the data is not pulled into the code, but the code is sent to the data. This makes it more scalable.



IAAtomicLong has one synchronous backup and no asynchronous backups. Its backup count is not configurable.

### 7.11.4. Split-Brain Protection for IAAtomicLong

IAAtomicLong can be configured to check for a minimum number of available members before applying its operations (see [Split-Brain Protection](#)). This is a check to avoid performing successful

operations on all parts of a cluster during a network partition. Following is a list of methods that now support Split-Brain Protection checks. The list is grouped by quorum type.

- WRITE, READ\_WRITE:
  - `addAndGet`
  - `addAndGetAsync`
  - `alter`
  - `alterAndGet`
  - `alterAndGetAsync`
  - `alterAsync`
  - `apply`
  - `applyAsync`
  - `compareAndSet`
  - `compareAndSetAsync`
  - `decrementAndGet`
  - `decrementAndGetAsync`
  - `getAndAdd`
  - `getAndAddAsync`
  - `getAndAlter`
  - `getAndAlterAsync`
  - `getAndIncrement`
  - `getAndIncrementAsync`
  - `getAndSet`
  - `getAndSetAsync`
  - `incrementAndGet`
  - `incrementAndGetAsync`
  - `set`
  - `setAsync`
- READ, READ\_WRITE:
  - `get`
  - `getAsync`

### Configuring Split-Brain Protection

Split-Brain protection for `IAtomicLong` can be configured programmatically using the method `setQuorumName()`, or declaratively using the element `quorum-ref`. Following is an example declarative configuration:

```
<atomic-long name="default">
  ...
  <quorum-ref>quorumname</quorum-ref>
  ...
</atomic-long>
```

The value of `quorum-ref` should be the quorum configuration name which you configured under the `quorum` element as explained in the [Split-Brain Protection section](#).

## 7.12. ISemaphore

Hazelcast ISemaphore is the distributed implementation of `java.util.concurrent.Semaphore`.

### 7.12.1. Controlling Thread Counts with Permits

Semaphores offer **permits** to control the thread counts when performing concurrent activities. To execute a concurrent activity, a thread grants a permit or waits until a permit becomes available. When the execution is completed, the permit is released.



ISemaphore with a single permit may be considered as a lock. Unlike the locks, when semaphores are used, any thread can release the permit, and semaphores can have multiple permits.



Hazelcast ISemaphore does not support fairness at all times. There are some edge cases where the fairness is not honored, e.g., when the permit becomes available at the time when an internal timeout occurs.

When a permit is acquired on ISemaphore:

- if there are permits, the number of permits in the semaphore is decreased by one and the calling thread performs its activity. If there is contention, the longest waiting thread will acquire the permit before all other threads.
- if no permits are available, the calling thread blocks until a permit becomes available. When a timeout happens during this block, the thread is interrupted.

### 7.12.2. Example Semaphore Code

The following example code uses an `IAtomicLong` resource 1000 times, increments the resource when a thread starts to use it and decrements it when the thread completes.

```

HazelcastInstance hazelcastInstance = Hazelcast.newHazelcastInstance();
ISemaphore semaphore = hazelcastInstance.getSemaphore( "semaphore" );
IAAtomicLong resource = hazelcastInstance.getAtomicLong( "resource" );
for ( int k = 0 ; k < 1000 ; k++ ) {
    System.out.println( "At iteration: " + k + ", Active Threads: " + resource.get()
);
    semaphore.acquire();
    try {
        resource.incrementAndGet();
        Thread.sleep( 1000 );
        resource.decrementAndGet();
    } finally {
        semaphore.release();
    }
}
System.out.println("Finished");

```

Let's limit the concurrent access to this resource by allowing at most three threads. You can configure it declaratively by setting the `initial-permits` property, as shown below.

```

<semaphore name="semaphore">
  <initial-permits>3</initial-permits>
</semaphore>

```



If there is a shortage of permits while the semaphore is being created, value of this property can be set to a negative number.

If you execute the above `SemaphoreMember` class 5 times, the output will be similar to the following:

```

At iteration: 0, Active Threads: 1
At iteration: 1, Active Threads: 2
At iteration: 2, Active Threads: 3
At iteration: 3, Active Threads: 3
At iteration: 4, Active Threads: 3

```

As you can see, the maximum count of concurrent threads is equal or smaller than three. If you remove the semaphore acquire/release statements in `SemaphoreMember`, you will see that there is no limitation on the number of concurrent usages.

Hazelcast also provides backup support for `ISemaphore`. When a member goes down, you can have another member take over the semaphore with the permit information (permits are automatically released when a member goes down). To enable this, configure synchronous or asynchronous backup with the properties `backup-count` and `async-backup-count` (by default, synchronous backup is already enabled).

### 7.12.3. Configuring Semaphore

The following are example semaphore configurations.

#### Declarative:

```
<semaphore name="semaphore">
  <backup-count>1</backup-count>
  <async-backup-count>0</async-backup-count>
  <initial-permits>3</initial-permits>
  <quorum-ref>quorumname</quorum-ref>
</semaphore>
```

#### Programmatic:

```
Config config = new Config();
SemaphoreConfig semaphoreConfig = config.getSemaphoreConfig("MySemaphore");
semaphoreConfig.setName( "semaphore" ).setBackupCount( 1 )
    .setInitialPermits( 3 )
    .setQuorumName( "quorumname" );
```

Semaphore configuration has the below elements.

- **initial-permits**: Thread count to which the concurrent access is limited. For example, if you set it to "3", concurrent access to the object is limited to 3 threads.
- **backup-count**: Number of synchronous backups.
- **async-backup-count**: Number of asynchronous backups.
- **quorum-ref**: Name of quorum configuration that you want this Semaphore to use. Please see the [Split-Brain Protection for ISemaphore](#) section below.



If high performance is more important than not losing the permit information, you can disable the backups by setting **backup-count** to 0.

### 7.12.4. Split-Brain Protection for ISemaphore

ISemaphore can be configured to check for a minimum number of available members before applying its operations (see [Split-Brain Protection](#)). This is a check to avoid performing successful queue operations on all parts of a cluster during a network partition.

Following is a list of methods that now support Split-Brain Protection checks. The list is grouped by quorum type.

- WRITE, READ\_WRITE:
  - **acquire**
  - **drainPermits**
  - **init**

- `reducePermits`
- `release`
- `tryAcquire`
- `READ, READ_WRITE`:
  - `availablePermits`

## Configuring Split-Brain Protection

Split-Brain protection for `ISemaphore` can be configured programmatically using the method `setQuorumName()`, or declaratively using the element `quorum-ref`. Following is an example declarative configuration:

```
<semaphore name="default">
  ...
  <quorum-ref>quorumname</quorum-ref>
  ...
</semaphore>
```

The value of `quorum-ref` should be the quorum configuration name which you configured under the `quorum` element as explained in the [Split-Brain Protection section](#).

## 7.13. IAtomicReference

The `IAtomicLong` is very useful if you need to deal with a long, but in some cases you need to deal with a reference. That is why Hazelcast also supports the `IAtomicReference` which is the distributed version of the `java.util.concurrent.atomic.AtomicReference`.

Here is an `IAtomicReference` example.

```
Config config = new Config();

HazelcastInstance hz = Hazelcast.newHazelcastInstance(config);

IAtomicReference<String> ref = hz.getAtomicReference("reference");
ref.set("foo");
System.out.println(ref.get());
System.exit(0);
```

When you execute the above example, you will see the following output.

```
foo
```

### 7.13.1. Sending Functions to IAtomicReference

Just like `IAtomicLong`, `IAtomicReference` has methods that accept a 'function' as an argument, such as `alter`, `alterAndGet`, `getAndAlter` and `apply`. There are two big advantages of using these methods:

- From a performance point of view, it is better to send the function to the data than the data to the function. Often the function is a lot smaller than the data and therefore cheaper to send over the line. Also the function only needs to be transferred once to the target machine and the data needs to be transferred twice.
- You do not need to deal with concurrency control. If you would perform a load, transform, store, you could run into a data race since another thread might have updated the value you are about to overwrite.

### 7.13.2. Using IAtomicReference

Below are some considerations you need to know when you use IAtomicReference.

- `IAtomicReference` works based on the byte-content and not on the object-reference. If you use the `compareAndSet` method, do not change to original value because its serialized content will then be different. It is also important to know that if you rely on Java serialization, sometimes (especially with hashmaps) the same object can result in different binary content.
- `IAtomicReference` will always have one synchronous backup.
- All methods returning an object will return a private copy. You can modify the private copy, but the rest of the world will be shielded from your changes. If you want these changes to be visible to the rest of the world, you need to write the change back to the `IAtomicReference`; but be careful about introducing a data-race.
- The 'in-memory format' of an `IAtomicReference` is `binary`. The receiving side does not need to have the class definition available unless it needs to be deserialized on the other side, e.g., because a method like 'alter' is executed. This deserialization is done for every call that needs to have the object instead of the binary content, so be careful with expensive object graphs that need to be deserialized.
- If you have an object with many fields or an object graph and you only need to calculate some information or need a subset of fields, you can use the `apply` method. With the `apply` method, the whole object does not need to be sent over the line; only the information that is relevant is sent.

### 7.13.3. Split-Brain Protection for IAtomicReference

IAtomicReference can be configured to check for a minimum number of available members before applying its operations (see [Split-Brain Protection](#)). This is a check to avoid performing successful operations on all parts of a cluster during a network partition.

Following is a list of methods that now support Split-Brain Protection checks. The list is grouped by quorum type.

- WRITE, READ\_WRITE:
  - `alter`
  - `alterAndGet`
  - `alterAndGetAsync`
  - `alterAsync`
  - `apply`
  - `applyAsync`

- `clear`
- `clearAsync`
- `compareAndSet`
- `compareAndSetAsync`
- `getAndAlter`
- `getAndAlterAsync`
- `getAndSet`
- `getAndSetAsync`
- `set`
- `setAndGet`
- `setAsync`
- `READ, READ_WRITE`:
  - `contains`
  - `containsAsync`
  - `get`
  - `getAsync`
  - `isNull`
  - `isNullAsync`

## Configuring Split-Brain Protection

Split-Brain protection for `IAtomicReference` can be configured programmatically using the method `setQuorumName()`, or declaratively using the element `quorum-ref`. Following is an example declarative configuration:

```
<atomic-reference name="default">
  ...
  <quorum-ref>quorumname</quorum-ref>
  ...
</atomic-reference>
```

The value of `quorum-ref` should be the quorum configuration name which you configured under the `quorum` element as explained in the [Split-Brain Protection section](#).

## 7.14. ICountDownLatch

Hazelcast `ICountDownLatch` is the distributed implementation of `java.util.concurrent.CountDownLatch`.

### 7.14.1. Gate-Keeping Concurrent Activities

`CountDownLatch` is considered to be a gate keeper for concurrent activities. It enables the threads to wait for other threads to complete their operations.

The following code samples describe the mechanism of `ICountDownLatch`. Assume that there is a



leader process and there are follower processes that will wait until the leader completes. Here is the leader:

```
public class Leader {
    public static void main( String[] args ) throws Exception {
        HazelcastInstance hazelcastInstance = Hazelcast.newHazelcastInstance();
        ICountDownLatch latch = hazelcastInstance.getCountDownLatch( "countDownLatch"
    );
        System.out.println( "Starting" );
        latch.trySetCount( 1 );
        Thread.sleep( 30000 );
        latch.countDown();
        System.out.println( "Leader finished" );
        latch.destroy();
    }
}
```

Since only a single step is needed to be completed as a sample, the above code initializes the latch with 1. Then, the code sleeps for a while to simulate a process and starts the countdown. Finally, it clears up the latch. Let's write a follower:

```
public class Follower {
    public static void main( String[] args ) throws Exception {
        HazelcastInstance hazelcastInstance = Hazelcast.newHazelcastInstance();
        ICountDownLatch latch = hazelcastInstance.getCountDownLatch( "countDownLatch"
    );
        System.out.println( "Waiting" );
        boolean success = latch.await( 10, TimeUnit.SECONDS );
        System.out.println( "Complete: " + success );
    }
}
```

The follower class above first retrieves `ICountDownLatch` and then calls the `await` method to enable the thread to listen for the latch. The method `await` has a timeout value as a parameter. This is useful when the `countDown` method fails. To see `ICountDownLatch` in action, start the leader first and then start one or more followers. You will see that the followers will wait until the leader completes.

## 7.14.2. Recovering From Failure

In a distributed environment, the counting down cluster member may go down. In this case, all listeners are notified immediately and automatically by Hazelcast. The state of the current process just before the failure should be verified and 'how to continue now' should be decided, e.g., restart all process operations, continue with the first failed process operation and throw an exception.

### 7.14.3. Using ICountDownLatch

Although the `ICountDownLatch` is a very useful synchronization aid, you will probably not use it on a daily basis. Unlike Java's implementation, Hazelcast's `ICountDownLatch` count can be reset after a countdown has finished, but not during an active count.



`ICountDownLatch` has 1 synchronous backup and no asynchronous backups. Its backup count is not configurable. Also, the count cannot be re-set during an active count, it should be re-set after the countdown is finished.

### 7.14.4. Split-Brain Protection for ICountDownLatch

`ICountDownLatch` can be configured to check for a minimum number of available members before applying `ICountDownLatch` operations (see [Split-Brain Protection](#)). This is a check to avoid performing successful queue operations on all parts of a cluster during a network partition.

Following is a list of methods that now support Split-Brain Protection checks. The list is grouped by quorum type.

- WRITE, READ\_WRITE:
  - `countDown`
  - `trySetCount`
- READ, READ\_WRITE:
  - `await`
  - `getCount`

#### Configuring Split-Brain Protection

Split-Brain protection for `ICountDownLatch` can be configured programmatically using the method `setQuorumName()`, or declaratively using the element `quorum-ref`. Following is an example declarative configuration:

```
<count-down-latch name="default">
  ...
  <quorum-ref>quorumname</quorum-ref>
  ...
</count-down-latch>
```

The value of `quorum-ref` should be the quorum configuration name which you configured under the `quorum` element as explained in the [Split-Brain Protection section](#).

## 7.15. PN Counter

A Conflict-free Replicated Data Type (CRDT) is a distributed data structure that achieves high availability by relaxing consistency constraints. There may be several replicas for the same data and these replicas can be modified concurrently without coordination. This means that you may achieve high throughput and low latency when updating a CRDT data structure. On the other hand,

all of the updates are replicated asynchronously. Each replica will then receive updates made on other replicas eventually and if no new updates are done, all replicas which can communicate to each other will return the same state (converge) after some time.

Hazelcast offers a lightweight CRDT PN counter (Positive-Negative Counter) implementation where each Hazelcast instance can increment and decrement the counter value and these updates are propagated to all replicas. Only a Hazelcast member can store state for a counter which means that counter method invocations performed on a Hazelcast member are usually local (depending on the configured replica count). If there is no member failure, it is guaranteed that each replica sees the final value of the counter eventually. Counter's state converges with each update and all CRDT replicas that can communicate to each other will eventually have the same state.

Using the PN Counter, you can get a distributed counter, increment and decrement it, and query its value with RYW (read-your-writes) and monotonic reads. The implementation borrows most methods from the `AtomicLong` which should be familiar in most cases and easily interchangeable in the existing code.

Some examples of PN counter are:

- counting the number of "likes" or "+1"
- counting the number of logged in users
- counting the number of page hits/views

### How it works

The counter supports adding and subtracting values as well as retrieving the current counter value. Each replica of this counter can perform operations locally without coordination with the other replicas, thus increasing availability. The counter guarantees that whenever two members have received the same set of updates, possibly in a different order, their state is identical, and any conflicting updates are merged automatically. If no new updates are made to the shared state, all members that can communicate will eventually have the same data.

The updates to the counter are applied locally when invoked on a CRDT replica. A CRDT replica can be any Hazelcast instance **which is NOT a client or a lite member**. You can configure the number of replicas in the cluster using the `replica-count` configuration element.

When invoking updates from a non-replica instance, the invocation is remote. This may lead to indeterminate state - the update may be applied but the response has not been received. In this case, the caller will be notified with a `TargetDisconnectedException` when invoked from a client or a `MemberLeftException` when invoked from a member.

The read and write methods provide monotonic read and RYW (read-your-write) guarantees. These guarantees are session guarantees which means that if no replica with the previously observed state is reachable, the session guarantees are lost and the method invocation will throw a `ConsistencyLostException`. This does not mean that an update is lost. All of the updates are part of some replica and will be eventually reflected in the state of all other replicas. This exception just means that you cannot observe your own writes because all replicas that contain your updates are currently unreachable. After you have received a `ConsistencyLostException`, you can either wait for a sufficiently up-to-date replica to become reachable in which case the session can be continued or

you can reset the session by calling the method `reset()`. If you have called this method, a new session is started with the next invocation to a CRDT replica.



The CRDT state is kept entirely on non-lite (data) members. If there aren't any and the methods here are invoked on a lite member, they fail with a `NoDataMemberInClusterException`.

The following is an example code.

```
final HazelcastInstance instance = Hazelcast.newHazelcastInstance();
final PNCOUNTER counter = instance.getPNCOUNTER("counter");
counter.addAndGet(5);
final long value = counter.get();
```

This code snippet creates an instance of a PN counter, increments it by 5 and retrieves the value.

### 7.15.1. Configuring PN Counter

Following is an example declarative configuration snippet:

```
<hazelcast>
  <pn-counter name="default">
    <replica-count>10</replica-count>
    <statistics-enabled>true</statistics-enabled>
  </pn-counter>
</hazelcast>
```

- **name**: Name of your PN Counter.
- **replica-count**: Number of replicas on which state for this PN counter will be kept. This number applies in quiescent state, if there are currently membership changes or clusters are merging, the state may be temporarily kept on more replicas. Its default value is `Integer.MAX_VALUE`. Generally, keeping the state on more replicas means that more Hazelcast members will be able to perform updates locally but it also means that the PN counter state will be kept on more replicas, increasing the network traffic, decreasing the speed at which replica states converge and increasing the size of the PN counter state kept on each replica.
- **statistics-enabled**: Specifies whether the statistics gathering will be enabled for your PN Counter. If set to `false`, you cannot collect statistics in your implementation and also Hazelcast Management Center will not show them. Its default value is `true`.

Following is an equivalent snippet of Java configuration:

```
PNCounterConfig pnCounterConfig = new PNCounterConfig("default")
    .setReplicaCount(10)
    .setStatisticsEnabled(true);
Config hazelcastConfig = new Config()
    .addPNCounterConfig(pnCounterConfig);
```

## 7.15.2. Configuring the CRDT replication mechanism



Configuring the replication mechanism is for advanced use cases only - usually the default configuration will work fine for most cases.

In some cases, you may want to configure the replication mechanism for all CRDT implementations. The CRDT states are replicated in rounds (the period is configurable) and in each round the state is replicated up to the configured number of members. Generally speaking, you may increase the speed at which replicas converge at the expense of more network traffic or decrease the network traffic at the expense of slower convergence of replicas. Hazelcast implements the state-based replication mechanism - the CRDT state for changed CRDTs is replicated in its entirety to other replicas on each replication round.

```
<hazelcast>
  <crdt-replication>
    <max-concurrent-replication-targets>1</max-concurrent-replication-targets>
    <replication-period-millis>1000</replication-period-millis>
  </crdt-replication>
</hazelcast>
```

- **max-concurrent-replication-targets**: The maximum number of target members that we replicate the CRDT states to in one period. A higher count will lead to states being disseminated more rapidly at the expense of burst-like behavior - one update to a CRDT will lead to a sudden burst in the number of replication messages in a short time interval. Its default value is 1 which means that each replica will replicate state to only one other replica in each replication round.
- **replication-period-millis**: The period between two replications of CRDT states in milliseconds. A lower value will increase the speed at which changes are disseminated to other cluster members at the expense of burst-like behavior - less updates will be batched together in one replication message and one update to a CRDT may cause a sudden burst of replication messages in a short time interval. The value must be a positive non-null integer. Its default value is 1000 milliseconds which means that the changed CRDT state is replicated every 1 second.

Following is an equivalent snippet of Java configuration:

```
final CRDTReplicationConfig crdtReplicationConfig = new CRDTReplicationConfig()
    .setMaxConcurrentReplicationTargets(1)
    .setReplicationPeriodMillis(1000);
Config hazelcastConfig = new Config()
    .setCRDTReplicationConfig(crdtReplicationConfig);
```

## 7.16. IdGenerator

Hazelcast IdGenerator is used to generate cluster-wide unique identifiers. Generated identifiers are long type primitive values between 0 and `Long.MAX_VALUE`.



**Feature is deprecated.** The implementation can produce duplicate IDs in case of a network split, even with split-brain protection enabled (during short window while split-brain is detected). Please use [FlakeIdGenerator](#) for an alternative implementation which does not suffer from the issue. Also see the [Migration guide](#) at the end of this section.

### 7.16.1. Generating Cluster-Wide IDs

ID generation occurs almost at the speed of `AtomicLong.incrementAndGet()`. A group of 10,000 identifiers is allocated for each cluster member. In the background, this allocation takes place with an `IAtomicLong` incremented by 10,000. Once a cluster member generates IDs (allocation is done), `IdGenerator` increments a local counter. If a cluster member uses all IDs in the group, it will get another 10,000 IDs. This way, only one time of network traffic is needed, meaning that 9,999 identifiers are generated in memory instead of over the network. This is fast.

Let's write a sample identifier generator.

```
HazelcastInstance hazelcastInstance = Hazelcast.newHazelcastInstance();
IdGenerator idGen = hazelcastInstance.getIdGenerator( "newId" );
while (true) {
    Long id = idGen.newId();
    System.err.println( "Id: " + id );
    Thread.sleep( 1000 );
}
```

Let's run the above code two times. The output will be similar to the following.

```
Members [1] {
  Member [127.0.0.1]:5701 this
}
Id: 1
Id: 2
Id: 3
```

```
Members [2] {
  Member [127.0.0.1]:5701
  Member [127.0.0.1]:5702 this
}
Id: 10001
Id: 10002
Id: 10003
```

### 7.16.2. Unique IDs and Duplicate IDs

You can see that the generated IDs are unique and counting upwards. If you see duplicated identifiers, it means your instances could not form a cluster.



Generated IDs are unique during the life cycle of the cluster. If the entire cluster is restarted, IDs start from 0, again or you can initialize to a value using the `init()` method of `IdGenerator`.



`IdGenerator` has one synchronous backup and no asynchronous backups. Its backup count is not configurable.

### 7.16.3. Migrating to `FlakeIdGenerator`

The Flake ID generator provides similar features with more safety guarantees during network splits. The two generators are completely different implementations, but both types of generator generate roughly ordered IDs. So in order to ensure uniqueness of the generated IDs, we can force the Flake ID generator to start at least where the old generator ended. This is likely the case, because the values from Flake generator are quite large compared to values from the old generator. Anyway, here are the steps you need to take:

- Make sure the version of your Hazelcast cluster and of all clients is at least 3.10.
- If the current ID from old `IdGenerator` is higher than the ID from `FlakeIdGenerator`, you need to configure ID offset. See [FlakeIdMigrationSample](#) for mor details.
- Replace all calls to `HazelcastInstance.getIdGenerator()` with `HazelcastInstance.getFlakeIdGenerator()`. If you use Spring configuration, replace `<id-generator>` with `<flake-id-generator>`

## 7.17. `FlakeIdGenerator`

Hazelcast Flake ID Generator is used to generate cluster-wide unique identifiers. Generated identifiers are `long` primitive values and are k-ordered (roughly ordered). IDs are in the range from 0 to `Long.MAX_VALUE`.

### 7.17.1. Generating Cluster-Wide IDs

The IDs contain timestamp component and a node ID component, which is assigned when the member joins the cluster. This allows the IDs to be ordered and unique without any coordination

between the members, which makes the generator safe even in split-brain scenarios (for limitations in this case, please see the [Node ID assignment section](#) below).

Timestamp component is in milliseconds since 1.1.2018, 0:00 UTC and has 41 bits. This caps the useful lifespan of the generator to little less than 70 years (until ~2088). The sequence component is 6 bits. If more than 64 IDs are requested in single millisecond, IDs will gracefully overflow to the next millisecond and uniqueness is guaranteed in this case. The implementation does not allow overflowing by more than 15 seconds, if IDs are requested at higher rate, the call will block. Note, however, that clients are able to generate even faster because each call goes to a different (random) member and the 64 IDs/ms limit is for single member.

### 7.17.2. Performance

Operation on member is always local, if the member has valid node ID, otherwise it's remote. On client, the `newId()` method goes to a random member and gets a batch of IDs, which will then be returned locally for limited time. The pre-fetch size and the validity time can be configured for each client and member.

### 7.17.3. Example

Let's write a sample identifier generator.

```
public class FlakeIdGeneratorSample {
    public static void main(String[] args) {
        HazelcastInstance hazelcast = Hazelcast.newHazelcastInstance();

        ClientConfig clientConfig = new ClientConfig()
            .addFlakeIdGeneratorConfig(new FlakeIdGeneratorConfig("idGenerator")
                .setPrefetchCount(10));
        HazelcastInstance client = HazelcastClient.newHazelcastClient(clientConfig);

        FlakeIdGenerator idGenerator = client.getFlakeIdGenerator("idGenerator");
        for (int i = 0; i < 10000; i++) {
            sleepSeconds(1);
            System.out.printf("Id: %s\n", idGenerator.newId());
        }
    }
}
```

### 7.17.4. Node ID Assignment

Flake IDs require a unique node ID to be assigned to each member, from which point the member can generate unique IDs without any coordination. Hazelcast uses the member list version from the moment when the member joined the cluster as a unique node ID.

The join algorithm is specifically designed to ensure that member list join version is unique for each member in the cluster. This ensures that IDs are unique even during network splits, with one caveat: at most one member is allowed to join the cluster during a network split. If two members



join different subclusters, they are likely to get the same node ID. This will be resolved when the cluster heals, but until then, they can generate duplicate IDs.

### Node ID Overflow

Node ID component of the ID has 16 bits. Members with the member list join version higher than  $2^{16}$  won't be able to generate IDs, but functionality will be preserved by forwarding to another member. It is possible to generate IDs on any member or client as long as there is at least one member with join version smaller than  $2^{16}$  in the cluster. The remedy is to restart the cluster: the node ID component will be reset and assigned starting from zero again. Uniqueness after the restart will be preserved thanks to the timestamp component.

## 7.18. Replicated Map

A Replicated Map is a distributed key-value data structure where the data is replicated to all members in the cluster. It provides full replication of entries to all members for high speed access. The following are its features:

- When you have a Replicated Map in the cluster, your clients can communicate with any cluster member.
- All cluster members are able to perform write operations.
- It supports all methods of the interface `java.util.Map`.
- It supports automatic initial fill up when a new member is started.
- It provides statistics for entry access, write and update so that you can monitor it using Hazelcast Management Center.
- New members joining to the cluster pull all the data from the existing members.
- You can listen to entry events using listeners. Please refer to [Using EntryListener on Replicated Map](#).

### 7.18.1. Replicating Instead of Partitioning

A Replicated Map does not partition data (it does not spread data to different cluster members); instead, it replicates the data to all members. All other data structures are partitioned in design.

Replication leads to higher memory consumption. However, a Replicated Map has faster read and write access since the data is available on all members.

Writes could take place on local/remote members in order to provide write-order, eventually being replicated to all other members.

Replicated Map is suitable for objects, catalog data, or idempotent calculable data (such as HTML pages). It fully implements the `java.util.Map` interface, but it lacks the methods from `java.util.concurrent.ConcurrentMap` since there are no atomic guarantees to writes or reads.



If Replicated Map is used from a unisocket client and this unisocket client is connected to a lite member, the entry listeners cannot be registered/de-registered.



You cannot use Replicated Map from a lite member. A `com.hazelcast.replicatedmap.ReplicatedMapCanBeCreatedOnLiteMemberException` is thrown if `com.hazelcast.core.HazelcastInstance.getReplicatedMap(name)` is invoked on a lite member.

## 7.18.2. Example Replicated Map Code

Here is an example of Replicated Map code. The `HazelcastInstance`'s `getReplicatedMap` method gets the Replicated Map, and the Replicated Map's `put` method creates map entries.

```
HazelcastInstance hz = Hazelcast.newHazelcastInstance();
Map<String, String> map = hz.getReplicatedMap("map");

map.put("1", "Tokyo");
map.put("2", "Paris");
map.put("3", "New York");

System.out.println("Finished loading map");
hz.shutdown();
```

`HazelcastInstance.getReplicatedMap()` returns `com.hazelcast.core.ReplicatedMap` which, as stated above, extends the `java.util.Map` interface.

The `com.hazelcast.core.ReplicatedMap` interface has some additional methods for registering entry listeners or retrieving values in an expected order.

## 7.18.3. Considerations for Replicated Map

If you have a large cluster or very high occurrences of updates, the Replicated Map may not scale linearly as expected since it has to replicate update operations to all members in the cluster.

Since the replication of updates is performed in an asynchronous manner, we recommend you enable back pressure in case your system has high occurrences of updates. Please refer to the [Back Pressure](#) section to learn how to enable it.

Replicated Map has an anti-entropy system that will converge values to a common one if some of the members are missing replication updates.

Replicated Map does not guarantee eventual consistency because there are some edge cases that fail to provide consistency.

Replicated Map uses the internal partition system of Hazelcast in order to serialize updates happening on the same key at the same time. This happens by sending updates of the same key to the same Hazelcast member in the cluster.

Due to the asynchronous nature of replication, a Hazelcast member could die before successfully replicating a "write" operation to other members after sending the "write completed" response to its caller during the write process. In this scenario, Hazelcast's internal partition system will

promote one of the replicas of the partition as the primary one. The new primary partition will not have the latest "write" since the dead member could not successfully replicate the update. (This will leave the system in a state that the caller is the only one that has the update and the rest of the cluster have not.) In this case even the anti-entropy system simply could not converge the value since the source of true information is lost for the update. This leads to a break in the eventual consistency because different values can be read from the system for the same key.

Other than the aforementioned scenario, the Replicated Map will behave like an eventually consistent system with read-your-writes and monotonic-reads consistency.

#### 7.18.4. Configuration Design for Replicated Map

There are several technical design decisions you should consider when you configure a Replicated Map.

##### Initial Provisioning

If a new member joins the cluster, there are two ways you can handle the initial provisioning that is executed to replicate all existing values to the new member. Each involves how you configure the async fill up.

First, you can configure `async fill up` to `true`, which does not block reads while the fill up operation is underway. That way, you have immediate access on the new member, but it will take time until all the values are eventually accessible. Not yet replicated values are returned as non-existing (`null`).

Second, you can configure for a synchronous initial fill up (by configuring the `async fill up` to `false`), which blocks every read or write access to the map until the fill up operation is finished. Use this with caution since it might block your application from operating.

#### 7.18.5. Configuring Replicated Map

Replicated Map can be configured programmatically or declaratively.

##### Declarative Configuration:

You can declare your Replicated Map configuration in the Hazelcast configuration file `hazelcast.xml`. Please see the following example.

```

<replicatedmap name="default">
  <in-memory-format>BINARY</in-memory-format>
  <async-fillup>true</async-fillup>
  <statistics-enabled>true</statistics-enabled>
  <entry-listeners>
    <entry-listener include-value="true">
      com.hazelcast.examples.EntryListener
    </entry-listener>
  </entry-listeners>
  <quorum-ref>quorumname</quorum-ref>
</replicatedmap>

```

- **in-memory-format**: Internal storage format. Please see the [In-Memory Format section](#). Its default value is **OBJECT**.
- **async-fillup**: Specifies whether the Replicated Map is available for reads before the initial replication is completed. Its default value is **true**. If set to **false** (i.e., synchronous initial fill up), no exception will be thrown when the Replicated Map is not yet ready, but **null** values can be seen until the initial replication is completed.
- **statistics-enabled**: If set to **true**, the statistics such as cache hits and misses are collected. Its default value is **true**.
- **entry-listener**: Full canonical classname of the **EntryListener** implementation.
  - **entry-listener#include-value**: Specifies whether the event includes the value or not. Sometimes the key is enough to react on an event. In those situations, setting this value to **false** will save a deserialization cycle. Its default value is **true**.
  - **entry-listener#local**: Not used for Replicated Map since listeners are always local.
- **quorum-ref**: Name of quorum configuration that you want this Replicated Map to use. Please see the [Split-Brain Protection for Replicated Map section](#).

### Programmatic Configuration:

You can configure a Replicated Map programmatically, as you can do for all other data structures in Hazelcast. You must create the configuration upfront, when you instantiate the **HazelcastInstance**. A basic example of how to configure the Replicated Map using the programmatic approach is shown in the following snippet.

```

Config config = new Config();

ReplicatedMapConfig replicatedMapConfig =
    config.getReplicatedMapConfig( "default" );

replicatedMapConfig.setInMemoryFormat( InMemoryFormat.BINARY )
    .setQuorumName( "quorumname" );

```

All properties that can be configured using the declarative configuration are also available using programmatic configuration by transforming the tag names into getter or setter names.

## In-Memory Format on Replicated Map

Currently, two `in-memory-format` values are usable with the Replicated Map.

- **OBJECT** (default): The data will be stored in deserialized form. This configuration is the default choice since the data replication is mostly used for high speed access. Please be aware that changing the values without a `Map.put()` is not reflected on the other members but is visible on the changing members for later value accesses.
- **BINARY**: The data is stored in serialized binary format and has to be deserialized on every request. This option offers higher encapsulation since changes to values are always discarded as long as the newly changed object is not explicitly `Map.put()` into the map again.

### 7.18.6. Using EntryListener on Replicated Map

A `com.hazelcast.core.EntryListener` used on a Replicated Map serves the same purpose as it would on other data structures in Hazelcast. You can use it to react on add, update and remove operations. Replicated Maps do not yet support eviction.

#### Difference in EntryListener on Replicated Map

The fundamental difference in Replicated Map behavior, compared to the other data structures, is that an `EntryListener` only reflects changes on local data. Since replication is asynchronous, all listener events are fired only when an operation is finished on a local member. Events can fire at different times on different members.

#### Example of Replicated Map EntryListener

Here is a code example for using `EntryListener` on a Replicated Map.

The `HazelcastInstance` s `getReplicatedMap` method gets a Replicated Map (customers), and the `ReplicatedMap` s `addEntryListener` method adds an entry listener to the Replicated Map. Then, the `ReplicatedMap` s `put` method adds a Replicated Map entry and updates it. The method `remove` removes the entry.

```

HazelcastInstance hz = Hazelcast.newHazelcastInstance();
ReplicatedMap<String, String> map = hz.getReplicatedMap("somemap");
map.addEntryListener(new MyEntryListener());
System.out.println("EntryListener registered");
}

private static class MyEntryListener implements EntryListener<String, String> {

    @Override
    public void entryAdded(EntryEvent<String, String> event) {
        System.out.println("entryAdded: " + event);
    }

    @Override
    public void entryRemoved(EntryEvent<String, String> event) {
        System.out.println("entryRemoved: " + event);
    }

    @Override
    public void entryUpdated(EntryEvent<String, String> event) {
        System.out.println("entryUpdated: " + event);
    }

    @Override
    public void entryEvicted(EntryEvent<String, String> event) {
        System.out.println("entryEvicted: " + event);
    }

    @Override
    public void mapEvicted(MapEvent event) {
        System.out.println("mapEvicted:" + event);
    }

    @Override
    public void mapCleared(MapEvent event) {
        System.out.println("mapCleared: " + event);
    }
}

```

### 7.18.7. Split-Brain Protection for Replicated Map

Replicated Map can be configured to check for a minimum number of available members before applying its operations (see [Split-Brain Protection](#)). This is a check to avoid performing successful queue operations on all parts of a cluster during a network partition.

Following is a list of methods that now support Split-Brain Protection checks. The list is grouped by quorum type.

- WRITE, READ\_WRITE:

- `clear`
- `put`
- `putAll`
- `remove`
- `READ, READ_WRITE`:
  - `containsKey`
  - `containsValue`
  - `entrySet`
  - `get`
  - `isEmpty`
  - `keySet`
  - `size`
  - `values`

### Configuring Split-Brain Protection

Split-Brain protection for Replicated Map can be configured programmatically using the method `setQuorumName()`, or declaratively using the element `quorum-ref`. Following is an example declarative configuration:

```
<replicatedmap name="default">
  ...
  <quorum-ref>quorumname</quorum-ref>
  ...
</replicatedmap>
```

The value of `quorum-ref` should be the quorum configuration name which you configured under the `quorum` element as explained in the [Split-Brain Protection section](#).

## 7.19. Cardinality Estimator Service

Hazelcast's cardinality estimator service is a data structure which implements Flajolet's HyperLogLog algorithm for estimating cardinalities of unique objects in theoretically huge data sets. The implementation offered by Hazelcast includes improvements from Google's version of the algorithm, i.e., HyperLogLog++.

The cardinality estimator service does not provide any ways to configure its properties, but rather uses some well tested defaults.

- **P**: Precision - 14, using the 14 LSB of the hash for the index.
- **M**:  $2^P = 16384$  (16K) registers
- **P'**: Sparse Precision - 25
- **Durability**: How many backups for each estimator, default 2



It is important to understand that this data structure is not 100% accurate, it is used to provide estimates. The error rate is typically a result of  $1.04/\sqrt{M}$  which in our implementation is around 0.81% for high percentiles.

The memory consumption of this data structure is close to 16K despite the size of elements in the source data set or stream.

There are two phases in using the cardinality estimator.

1. Add objects to the instance of the estimator, e.g., for IPs `estimator.add("0.0.0.0")`. The provided object is first serialized and then the byte array is used to generate a hash for that object.



Objects must be serializable in a form that Hazelcast understands.

2. Compute the estimate of the set so far `estimator.estimate()`.

Please see the [cardinality estimator Javadoc](#) for more information on its API.

The following is an example code.

```
HazelcastInstance hz = Hazelcast.newHazelcastInstance();
CardinalityEstimator visitorsEstimator = hz.getCardinalityEstimator("visitors");

InputStreamReader isr = new InputStreamReader(CardinalityEstimatorSample.class
    .getResourceAsStream("visitors.txt"));
BufferedReader br = new BufferedReader(isr);
try {
    String visitor = br.readLine();
    while (visitor != null) {
        visitorsEstimator.add(visitor);
        visitor = br.readLine();
    }
} catch (IOException e) {
    e.printStackTrace();
} finally {
    closeResource(br);
    closeResource(isr);
}

System.out.printf("Estimated unique visitors seen so far: %d\n", visitorsEstimator
    .estimate());

Hazelcast.shutdownAll();
```

### 7.19.1. Split-Brain Protection for Cardinality Estimator

Cardinality Estimator can be configured to check for a minimum number of available members before applying its operations (see [Split-Brain Protection](#)). This is a check to avoid performing



successful queue operations on all parts of a cluster during a network partition.

Following is a list of methods that now support Split-Brain Protection checks. The list is grouped by quorum type.

- WRITE, READ\_WRITE:
  - `add`
  - `addAsync`
- READ, READ\_WRITE:
  - `estimate`
  - `estimateAsync`

## Configuring Split-Brain Protection

Split-Brain protection for Cardinality Estimator can be configured programmatically using the method `setQuorumName()`, or declaratively using the element `quorum-ref`. Following is an example declarative configuration:

```
<cardinality-estimator name="default">
  ...
  <quorum-ref>quorumname</quorum-ref>
  ...
</cardinality-estimator>
[source,xml]
```

The value of `quorum-ref` should be the quorum configuration name which you configured under the `quorum` element as explained in the [Split-Brain Protection section](#).

## Configuring Merge Policy

While recovering from a Split-Brain syndrome, Cardinality Estimator in the small cluster merges into the bigger cluster based on a configured merge policy. When an estimator merges into the cluster, an estimator with the same name might already exist in the cluster. So the merge policy resolves these kinds of conflicts with different out-of-the-box strategies. It can be configured programmatically using the method `setMergePolicyConfig()`, or declaratively using the element `merge-policy`. Following is an example declarative configuration:

```
<cardinality-estimator name="default">
  ...
  <merge-policy>HyperLogLogMergePolicy</merge-policy>
  ...
</cardinality-estimator>
```

Following out-of-the-box merge policies are available:

- `DiscardMergePolicy`: Estimator from the smaller cluster will be discarded.
- `HyperLogLogMergePolicy`: Estimator will merge with the existing one, using the algorithmic merge

for HyperLogLog. This is the default policy.

- `PassThroughMergePolicy`: Estimator from the smaller cluster wins.
- `PutIfAbsentMergePolicy`: Estimator from the smaller cluster wins if it doesn't exist in the cluster.

## 7.20. Event Journal

The event journal is a distributed data structure that stores the history of mutation actions on map or cache. Each action on the map or cache which modifies its contents (such as `put`, `remove` or scheduled tasks which are not triggered by using the public API) will create an event which will be stored in the event journal. The event will store the event type as well as the key, old value and updated value for the entry (when applicable). As a user, you can only append to the journal indirectly by using the map and cache methods or by configuring expiration and eviction. By reading from the event journal you can recreate the state of the map or cache at any point in time.



Currently the event journal does not expose a public API for reading the event journal in Hazelcast IMDG. The event journal can be used to stream event data to Hazelcast Jet, so it should be used in conjunction with [Hazelcast Jet](#). Because of this we will describe how to configure it but not how to use it from IMDG. If you enable and configure the event journal, you may only reach it through private API and you will most probably not get any benefits but the journal will retain events nevertheless and consume heap space.

The event journal has a fixed capacity and an expiration time. Internally it is structured as a ringbuffer (partitioned by ringbuffer item) and shares many similarities with it.

### 7.20.1. Interaction with Evictions and Expiration for IMap

Configuring IMap with eviction and expiration can cause the event journal to contain different events on the different replicas of the same partition. You can run into issues if you are reading from the event journal and the partition owner is terminated. A backup replica will then be promoted into the partition owner but the event journal will contain different events. The event count should stay the same but the entries which you previously thought were evicted and expired could now be "alive" and vice versa.

This is because eviction and expiration randomly choose entries to be evicted/expired. The entry is not coordinated between partition replicas. In these cases, the event journal diverges and will not converge at any future point but will remain inconsistent just as well as the contents of the internal record stores are inconsistent between replicas. You may say that the event journal on a specific replica is in-sync with the record store on that replica but the event journals and record stores between replicas are out-of-sync.

### 7.20.2. Configuring Event Journal Capacity

By default, an event journal is configured with a `capacity` of 10000 items. This creates a single array per partition, roughly the size of the capacity divided by the number of partitions. Thus, if the configured capacity is 10000 and the number of partitions is 271, we will create 271 arrays of size 36 (10000/271). If a `time-to-live` is configured, then an array of longs is also created that stores the

expiration time for every item. A single array of the event journal keeps events that are only related to the map entries in that partition. In a lot of cases you may want to change this `capacity` number to something that better fits your needs. As the capacity is shared between partitions, keep in mind not to set it to a value which is too low for you. Setting the capacity to a number lower than the partition count will result in an error when initializing the event journal.

Below is a declarative configuration example of an event journal with a `capacity` of 5000 items for a map and 10000 items for a cache:

```
<event-journal enabled="true">
  <mapName>myMap</mapName>
  <capacity>5000</capacity>
  <time-to-live-seconds>20</time-to-live-seconds>
</event-journal>

<event-journal enabled="true">
  <cacheName>myCache</cacheName>
  <capacity>10000</capacity>
  <time-to-live-seconds>0</time-to-live-seconds>
</event-journal>
```

You can also configure an event journal programmatically. The following is a programmatic version of the above declarative configuration:

```
EventJournalConfig myMapJournalConfig = new EventJournalConfig()
    .setMapName("myMap")
    .setEnabled(true)
    .setCapacity(5000)
    .setTimeToLiveSeconds(20);

EventJournalConfig myCacheJournalConfig = new EventJournalConfig()
    .setMapName("myCache")
    .setEnabled(true)
    .setCapacity(10000)
    .setTimeToLiveSeconds(0);

Config config = new Config();
config.addEventJournalConfig(myMapJournalConfig);
config.addEventJournalConfig(myCacheJournalConfig);
```

The `mapName` and `cacheName` attributes define the map or cache to which this event journal configuration applies. You can use pattern-matching and the `default` keyword when doing so. For instance, by using a `mapName` of `journalled*`, the journal configuration will apply to all maps whose names start with "journalled" and don't have other journal configurations that match (e.g., if you would have a more specific journal configuration with an exact name match). If you specify the `mapName` or `cacheName` as `default`, the journal configuration will apply to all maps and caches that don't have any other journal configuration. This means that potentially all maps and/or caches will have one single event journal configuration.

### 7.20.3. Event Journal Partitioning

The event journal is a partitioned data structure. The partitioning is done by the event key. Because of this, the map and cache entry with a specific key is co-located with the events for that key and will be migrated accordingly. Also, the backup count for the event journal is equal to the backup count of the map or cache for which it contains events. The events on the backup replicas will be created with the map or cache backup operations and no additional network traffic is introduced when appending events to the event journal.

### 7.20.4. Configuring Event Journal time-to-live

You can configure Hazelcast event journal with a `time-to-live` in seconds. Using this setting, you can control how long the items remain in the event journal before they are expired. By default, the `time-to-live` is set to 0, meaning that unless the item is overwritten, it will remain in the journal indefinitely. The expiration time of the existing journal events is checked whenever a new event is appended to the event journal or when the event journal is being read. If the journal is not being read or written to, the journal may keep expired items indefinitely.

In the example below, an event journal is configured with a `time-to-live` of 180 seconds:

```
<event-journal enabled="true">
  <cacheName>myCache</cacheName>
  <capacity>10000</capacity>
  <time-to-live-seconds>180</time-to-live-seconds>
</event-journal>
```

## 8. Distributed Events

You can register for Hazelcast entry events so you will be notified when those events occur. Event Listeners are cluster-wide—when a listener is registered in one member of cluster, it is actually registered for events that originated at any member in the cluster. When a new member joins, events originated at the new member will also be delivered.

An Event is created only if you registered an event listener. If no listener is registered, then no event will be created. If you provided a predicate when you registered the event listener, pass the predicate before sending the event to the listener (member/client).

As a rule of thumb, your event listener should not implement heavy processes in its event methods that block the thread for a long time. If needed, you can use `ExecutorService` to transfer long running processes to another thread and thus offload the current listener thread.



In a failover scenario, events are not highly available and may get lost. Eventing mechanism is being improved for failover scenarios.

Hazelcast offers the following event listeners.

For cluster events:

- **Membership Listener** for cluster membership events.
- **Distributed Object Listener** for distributed object creation and destroy events.
- **Migration Listener** for partition migration start and complete events.
- **Partition Lost Listener** for partition lost events.
- **Lifecycle Listener** for `HazelcastInstance` lifecycle events.
- **Client Listener** for client connection events.

For distributed object events:

- **Entry Listener** for `IMap` and `MultiMap` entry events.
- **Item Listener** for `IQueue`, `ISet` and `IList` item events.
- **Message Listener** for `ITopic` message events.

For Hazelcast JCache implementation:

- **Cache Entry Listener**, please see [CacheEntryListener](#).
- **Cache Partition Lost Listener**, please see [ICache Partition Lost Listener](#).

For Hazelcast clients:

- **Lifecycle Listener**
- **Membership Listener**
- **Distributed Object Listener**

## 8.1. Cluster Events

### 8.1.1. Listening for Member Events

The Membership Listener interface has methods that are invoked for the following events.

- **memberAdded**: A new member is added to the cluster.
- **memberRemoved**: An existing member leaves the cluster.
- **memberAttributeChanged**: An attribute of a member is changed. Please refer to [Defining Member Attributes](#) to learn about member attributes.

To write a Membership Listener class, you implement the `MembershipListener` interface and its methods.

The following is an example Membership Listener class.

```

public class ClusterMembershipListener implements MembershipListener {

    public void memberAdded(MembershipEvent membershipEvent) {
        System.err.println("Added: " + membershipEvent);
    }

    public void memberRemoved(MembershipEvent membershipEvent) {
        System.err.println("Removed: " + membershipEvent);
    }

    public void memberAttributeChanged(MemberAttributeEvent memberAttributeEvent) {
        System.err.println("Member attribute changed: " + memberAttributeEvent);
    }
}

```

When a respective event is fired, the membership listener outputs the addresses of the members that joined and left, and also which attribute changed on which member.

### Registering Membership Listeners

After you create your class, you can configure your cluster to include the membership listener. Below is an example using the method `addMembershipListener`.

```

HazelcastInstance hazelcastInstance = Hazelcast.newHazelcastInstance();
hazelcastInstance.getCluster().addMembershipListener( new ClusterMembershipListener()
);

```

With the above approach, there is the possibility of missing events between the creation of the instance and registering the listener. To overcome this race condition, Hazelcast allows you to register listeners in the configuration. You can register listeners using declarative, programmatic, or Spring configuration, as shown below.

The following is an example programmatic configuration.

```

Config config = new Config();
config.addListenerConfig(
new ListenerConfig( "com.yourpackage.ClusterMembershipListener" ) );

```

The following is an example of the equivalent declarative configuration.

```

<hazelcast>
  ...
  <listeners>
    <listener>
      com.yourpackage.ClusterMembershipListener
    </listener>
  </listeners>
  ...
</hazelcast>

```

The following is an example of the equivalent Spring configuration.

```

<hz:listeners>
  <hz:listener class-name="com.yourpackage.ClusterMembershipListener"/>
  <hz:listener implementation="MembershipListener"/>
</hz:listeners>

```

### 8.1.2. Listening for Distributed Object Events

The Distributed Object Listener methods `distributedObjectCreated` and `distributedObjectDestroyed` are invoked when a distributed object is created and destroyed throughout the cluster. To write a Distributed Object Listener class, you implement the `DistributedObjectListener` interface and its methods.

The following is an example Distributed Object Listener class.

```

public class SampleDistObjListener implements DistributedObjectListener {

    @Override
    public void distributedObjectCreated(DistributedObjectEvent event) {
        DistributedObject instance = event.getDistributedObject();
        System.out.println("Created " + instance.getName() + ", service=" + instance
            .getServiceName());
    }

    @Override
    public void distributedObjectDestroyed(DistributedObjectEvent event) {
        System.out.println("Destroyed " + event.getObjectname() + ", service=" +
            event.getServiceName());
    }
}

```

When a respective event is fired, the distributed object listener outputs the event type, the object name and a service name (for example, for a Map object the service name is `"hz:impl:mapService"`).

## Registering Distributed Object Listeners

After you create your class, you can configure your cluster to include distributed object listeners. Below is an example using the method `addDistributedObjectListener`. You can also see this portion in the above class creation.

```
HazelcastInstance hazelcastInstance = Hazelcast.newHazelcastInstance();
SampleDistObjListener sample = new SampleDistObjListener();

hazelcastInstance.addDistributedObjectListener( sample );
```

With the above approach, there is the possibility of missing events between the creation of the instance and registering the listener. To overcome this race condition, Hazelcast allows you to register the listeners in the configuration. You can register listeners using declarative, programmatic, or Spring configuration, as shown below.

The following is an example programmatic configuration.

```
config.addListenerConfig(
    new ListenerConfig( "com.yourpackage.SampleDistObjListener" ) );
```

The following is an example of the equivalent declarative configuration.

```
<hazelcast>
  ...
  <listeners>
    <listener>
      com.yourpackage.SampleDistObjListener
    </listener>
  </listeners>
  ...
</hazelcast>
```

The following is an example of the equivalent Spring configuration.

```
<hz:listeners>
  <hz:listener class-name="com.yourpackage.SampleDistObjListener"/>
  <hz:listener implementation="DistributedObjectListener"/>
</hz:listeners>
```

### 8.1.3. Listening for Migration Events

The Migration Listener interface has methods that are invoked for the following events:

- `migrationStarted`: A partition migration is started.
- `migrationCompleted`: A partition migration is completed.



- `migrationFailed`: A partition migration failed.

To write a Migration Listener class, you implement the `MigrationListener` interface and its methods.

The following is an example Migration Listener class.

```
public class ClusterMigrationListener implements MigrationListener {
    @Override
    public void migrationStarted(MigrationEvent migrationEvent) {
        System.err.println("Started: " + migrationEvent);
    }
    @Override
    public void migrationCompleted(MigrationEvent migrationEvent) {
        System.err.println("Completed: " + migrationEvent);
    }
    @Override
    public void migrationFailed(MigrationEvent migrationEvent) {
        System.err.println("Failed: " + migrationEvent);
    }
}
```

When a respective event is fired, the migration listener outputs the partition ID, status of the migration, the old member and the new member. The following is an example output.

```
Started: MigrationEvent{partitionId=98, oldOwner=Member [127.0.0.1]:5701,
newOwner=Member [127.0.0.1]:5702 this}
```

## Registering Migration Listeners

After you create your class, you can configure your cluster to include migration listeners. Below is an example using the method `addMigrationListener`.

```
HazelcastInstance hazelcastInstance = Hazelcast.newHazelcastInstance();

PartitionService partitionService = hazelcastInstance.getPartitionService();
partitionService.addMigrationListener( new ClusterMigrationListener() );
```

With the above approach, there is the possibility of missing events between the creation of the instance and registering the listener. To overcome this race condition, Hazelcast allows you to register the listeners in the configuration. You can register listeners using declarative, programmatic, or Spring configuration, as shown below.

The following is an example programmatic configuration.

```
config.addListenerConfig(
    new ListenerConfig( "com.yourpackage.ClusterMigrationListener" ) );
```

The following is an example of the equivalent declarative configuration.

```
<hazelcast>
  ...
  <listeners>
    <listener>
      com.yourpackage.ClusterMigrationListener
    </listener>
  </listeners>
  ...
</hazelcast>
```

The following is an example of the equivalent Spring configuration.

```
<hz:listeners>
  <hz:listener class-name="com.yourpackage.ClusterMigrationListener"/>
  <hz:listener implementation="MigrationListener"/>
</hz:listeners>
```

#### 8.1.4. Listening for Partition Lost Events

Hazelcast provides fault-tolerance by keeping multiple copies of your data. For each partition, one of your cluster members becomes the owner and some of the other members become replica members, based on your configuration. Nevertheless, data loss may occur if a few members crash simultaneously.

Let's consider the following example with three members: N1, N2, N3 for a given partition-0. N1 is owner of partition-0. N2 and N3 are the first and second replicas respectively. If N1 and N2 crash simultaneously, partition-0 loses its data that is configured with less than two backups. For instance, if we configure a map with one backup, that map loses its data in partition-0 since both owner and first replica of partition-0 have crashed. However, if we configure our map with two backups, it does not lose any data since a copy of partition-0's data for the given map also resides in N3.

The Partition Lost Listener notifies for possible data loss occurrences with the information of how many replicas are lost for a partition. It listens to `PartitionLostEvent` instances. Partition lost events are dispatched per partition.

Partition loss detection is done after a member crash is detected by the other members and the crashed member is removed from the cluster. Please note that false-positive `PartitionLostEvent` instances may be fired on the network split errors.

#### Writing a Partition Lost Listener Class

To write a Partition Lost Listener, you implement the `PartitionLostListener` interface and its `partitionLost` method, which is invoked when a partition loses its owner and all backups.

The following is an example Partition Lost Listener class.

```
public class ConsoleLoggingPartitionLostListener implements PartitionLostListener {
    @Override
    public void partitionLost(PartitionLostEvent event) {
        System.out.println(event);
    }
}
```

When a `PartitionLostEvent` is fired, the partition lost listener given above outputs the partition ID, the replica index that is lost and the member that has detected the partition loss. The following is an example output.

```
com.hazelcast.partition.PartitionLostEvent{partitionId=242, lostBackupCount=0,
eventSource=Address[192.168.2.49]:5701}
```

### Registering Partition Lost Listeners

After you create your class, you can configure your cluster programmatically or declaratively to include the partition lost listener. Below is an example of its programmatic configuration.

```
HazelcastInstance hazelcastInstance = Hazelcast.newHazelcastInstance();
hazelcastInstance.getPartitionService().addPartitionLostListener( new
ConsoleLoggingPartitionLostListener() );
```

The following is an example of the equivalent declarative configuration.

```
<hazelcast>
...
<listeners>
  <listener>
    com.yourpackage.ConsoleLoggingPartitionLostListener
  </listener>
</listeners>
...
</hazelcast>
```

### 8.1.5. Listening for Lifecycle Events

The Lifecycle Listener notifies for the following events:

- **STARTING**: A member is starting.
- **STARTED**: A member started.
- **SHUTTING\_DOWN**: A member is shutting down.
- **SHUTDOWN**: A member's shutdown has completed.
- **MERGING**: A member is merging with the cluster.

- **MERGED**: A member's merge operation has completed.
- **CLIENT\_CONNECTED**: A Hazelcast Client connected to the cluster.
- **CLIENT\_DISCONNECTED**: A Hazelcast Client disconnected from the cluster.

The following is an example Lifecycle Listener class.

```
public class NodeLifecycleListener implements LifecycleListener {
    @Override
    public void stateChanged(LifecycleEvent event) {
        System.err.println(event);
    }
}
```

This listener is local to an individual member. It notifies the application that uses Hazelcast about the events mentioned above for a particular member.

### Registering Lifecycle Listeners

After you create your class, you can configure your cluster to include lifecycle listeners. Below is an example using the method `addLifecycleListener`.

```
HazelcastInstance hazelcastInstance = Hazelcast.newHazelcastInstance();
hazelcastInstance.getLifecycleService().addLifecycleListener( new
NodeLifecycleListener() );
```

With the above approach, there is the possibility of missing events between the creation of the instance and registering the listener. To overcome this race condition, Hazelcast allows you to register the listeners in the configuration. You can register listeners using declarative, programmatic, or Spring configuration, as shown below.

The following is an example programmatic configuration.

```
config.addListenerConfig(
    new ListenerConfig( "com.yourpackage.NodeLifecycleListener" ) );
```

The following is an example of the equivalent declarative configuration.

```

<hazelcast>
  ...
  <listeners>
    <listener>
      com.yourpackage.NodeLifecycleListener
    </listener>
  </listeners>
  ...
</hazelcast>

```

The following is an example of the equivalent Spring configuration.

```

<hz:listeners>
  <hz:listener class-name="com.yourpackage.NodeLifecycleListener"/>
  <hz:listener implementation="LifecycleListener"/>
</hz:listeners>

```

### 8.1.6. Listening for Clients

The Client Listener is used by the Hazelcast cluster members. It notifies the cluster members when a client is connected to or disconnected from the cluster.

To write a client listener class, you implement the `ClientListener` interface and its methods `clientConnected` and `clientDisconnected`, which are invoked when a client is connected to or disconnected from the cluster. You can add your client listener as shown below.

```

hazelcastInstance.getClientService().addClientListener(new SampleClientListener());

```

The following is the equivalent declarative configuration.

```

<listeners>
  <listener>
    com.yourpackage.SampleClientListener
  </listener>
</listeners>

```

The following is the equivalent configuration in the Spring context.

```

<hz:listeners>
  <hz:listener class-name="com.yourpackage.SampleClientListener"/>
  <hz:listener implementation="com.yourpackage.SampleClientListener"/>
</hz:listeners>

```



You can also add event listeners to a Hazelcast client. Please refer to [Client Listenerconfig](#) for the related information.

## 8.2. Distributed Object Events

### 8.2.1. Listening for Map Events

You can listen to map-wide or entry-based events using the listeners provided by the Hazelcast's eventing framework. To listen to these events, implement a `MapListener` sub-interface.

A map-wide event is fired as a result of a map-wide operation. For example, `IMap.clear()` or `IMap.evictAll()`. An entry-based event is fired after the operations that affect a specific entry. For example, `IMap.remove()` or `IMap.evict()`.

#### Catching a Map Event

To catch an event, you should explicitly implement a corresponding sub-interface of a `MapListener`, such as `EntryAddedListener` or `MapClearedListener`.



The `EntryListener` interface still can be implemented (we kept it for backward compatibility reasons). However, if you need to listen to a different event, one that is not available in the `EntryListener` interface, you should also implement a relevant `MapListener` sub-interface.

Let's take a look at the following class example.

```
public class Listen {

    public static void main( String[] args ) {
        HazelcastInstance hz = Hazelcast.newHazelcastInstance();
        IMap<String, String> map = hz.getMap( "somemap" );
        map.addEntryListener( new MyEntryListener(), true );
        System.out.println( "EntryListener registered" );
    }

    static class MyEntryListener implements
        EntryAddedListener<String, String>,
        EntryRemovedListener<String, String>,
        EntryUpdatedListener<String, String>,
        EntryEvictedListener<String, String>,
        EntryLoadedListener<String, String>,
        MapEvictedListener,
        MapClearedListener {

        @Override
        public void entryAdded( EntryEvent<String, String> event ) {
            System.out.println( "Entry Added:" + event );
        }
    }
}
```

```

@Override
public void entryRemoved( EntryEvent<String, String> event ) {
    System.out.println( "Entry Removed:" + event );
}

@Override
public void entryUpdated( EntryEvent<String, String> event ) {
    System.out.println( "Entry Updated:" + event );
}

@Override
public void entryEvicted( EntryEvent<String, String> event ) {
    System.out.println( "Entry Evicted:" + event );
}

@Override
public void entryLoaded( EntryEvent<String, String> event ) {
    System.out.println( "Entry Loaded:" + event );
}

@Override
public void mapEvicted( MapEvent event ) {
    System.out.println( "Map Evicted:" + event );
}

@Override
public void mapCleared( MapEvent event ) {
    System.out.println( "Map Cleared:" + event );
}
}
}

```

Now, let's perform some modifications on the map entries using the following example code.

```

public class ModifyMap {

    public static void main( String[] args ) {
        HazelcastInstance hz = Hazelcast.newHazelcastInstance();
        IMap<String, String> map = hz.getMap( "somemap" );
        String key = "" + System.nanoTime();
        String value = "1";
        map.put( key, value );
        map.put( key, "2" );
        map.delete( key );
    }
}

```

If you execute the `Listen` class and then the `Modify` class, you get the following output produced by the `Listen` class.

```
Entry Added:EntryEvent{entryEventType=ADDED, member=Member [192.168.1.100]:5702
- ffedb655-bbad-43ea-ae8-d429d37ce528, name='somemap', key=11455268066242,
oldValue=null, value=1, mergingValue=null}
```

```
Entry Updated:EntryEvent{entryEventType=UPDATED, member=Member [192.168.1.100]:5702
- ffedb655-bbad-43ea-ae8-d429d37ce528, name='somemap', key=11455268066242,
oldValue=1, value=2, mergingValue=null}
```

```
Entry Removed:EntryEvent{entryEventType=REMOVED, member=Member [192.168.1.100]:5702
- ffedb655-bbad-43ea-ae8-d429d37ce528, name='somemap', key=11455268066242,
oldValue=null, value=null, mergingValue=null}
```



Please note that the method `IMap.clear()` does not fire an "EntryRemoved" event, but fires a "MapCleared" event.



Listeners have to offload all blocking operations to another thread (pool).

## 8.2.2. Listening for Lost Map Partitions

You can listen to `MapPartitionLostEvent` instances by registering an implementation of `MapPartitionLostListener`, which is also a sub-interface of `MapListener`.

Let's consider the following example code:

```
public class ListenMapPartitionLostEvents {

    public static void main(String[] args) {
        Config config = new Config();
        // keeps its data if a single node crashes
        config.getMapConfig("map").setBackupCount(1);

        HazelcastInstance instance = HazelcastInstanceFactory.newHazelcastInstance
(config);

        IMap<Object, Object> map = instance.getMap("map");
        map.put(0, 0);

        map.addPartitionLostListener(new MapPartitionLostListener() {
            @Override
            public void partitionLost(MapPartitionLostEvent event) {
                System.out.println(event);
            }
        });
    }
}
```

Within this example code, a `MapPartitionLostListener` implementation is registered to a map that is



configured with one backup. For this particular map and any of the partitions in the system, if the partition owner member and its first backup member crash simultaneously, the given `MapPartitionLostListener` receives a corresponding `MapPartitionLostEvent`. If only a single member crashes in the cluster, there will be no `MapPartitionLostEvent` fired for this map since backups for the partitions owned by the crashed member are kept on other members.

Please refer to [Listening for Partition Lost Events](#) for more information about partition lost detection and partition lost events.

## Registering Map Listeners

After you create your listener class, you can configure your cluster to include map listeners using the method `addEntryListener` (as you can see in the example `Listen` class above). Below is the related portion from this code, showing how to register a map listener.

```
HazelcastInstance hz = Hazelcast.newHazelcastInstance();
IMap<String, String> map = hz.getMap( "somemap" );
map.addEntryListener( new MyEntryListener(), true );
```

With the above approach, there is the possibility of missing events between the creation of the instance and registering the listener. To overcome this race condition, Hazelcast allows you to register listeners in configuration. You can register listeners using declarative, programmatic, or Spring configuration, as shown below.

The following is an example programmatic configuration.

```
mapConfig.addEntryListenerConfig(
    new EntryListenerConfig( "com.yourpackage.MyEntryListener",
                             false, false ) );
```

The following is an example of the equivalent declarative configuration.

```
<hazelcast>
  ...
  <map name="somemap">
    ...
    <entry-listeners>
      <entry-listener include-value="false" local="false">
        com.yourpackage.MyEntryListener
      </entry-listener>
    </entry-listeners>
  </map>
  ...
</hazelcast>
```

The following is an example of the equivalent Spring configuration.

```

<hz:map name="somemap">
  <hz:entry-listeners>
    <hz:entry-listener include-value="true"
      class-name="com.hazelcast.spring.DummyEntryListener"/>
    <hz:entry-listener implementation="dummyEntryListener" local="true"/>
  </hz:entry-listeners>
</hz:map>

```

### Map Listener Attributes

As you see, there are attributes of the map listeners in the above examples: `include-value` and `local`. The attribute `include-value` is a boolean attribute that is optional, and if you set it to `true`, the map event will contain the map value. Its default value is `true`.

The attribute `local` is also a boolean attribute that is optional, and if you set it to `true`, you can listen to the map on the local member. Its default value is `false`.

### 8.2.3. Listening for MultiMap Events

You can listen to entry-based events in the MultiMap using `EntryListener`. The following is an example entry listener implementation for MultiMap.

```

public class SampleEntryListener implements EntryListener<String, String> {
    @Override
    public void entryAdded(EntryEvent<String, String> event) {
        System.out.println("Entry Added: " + event);
    }
    @Override
    public void entryRemoved( EntryEvent<String, String> event ) {
        System.out.println( "Entry Removed: " + event );
    }
    @Override
    public void entryUpdated(EntryEvent<String, String> event) {
        System.out.println( "Entry Updated: " + event );
    }
    @Override
    public void entryEvicted(EntryEvent<String, String> event) {
        System.out.println( "Entry evicted: " + event );
    }
    @Override
    public void mapCleared(MapEvent event) {
        System.out.println( "Map Cleared: " + event );
    }
    @Override
    public void mapEvicted(MapEvent event) {
        System.out.println( "Map Evicted: " + event );
    }
}

```

## Registering MultiMap Listeners

After you create your listener class, you can configure your cluster to include MultiMap listeners using the method `addEntryListener`. Below is the related portion from a code, showing how to register a map listener.

```
HazelcastInstance hz = Hazelcast.newHazelcastInstance();
MultiMap<String, String> map = hz.getMultiMap( "somemap" );
map.addEntryListener( new SampleEntryListener(), true );
```

With the above approach, there is the possibility of missing events between the creation of the instance and registering the listener. To overcome this race condition, Hazelcast allows you to register listeners in the configuration. You can register listeners using declarative, programmatic, or Spring configuration, as shown below.

The following is an example programmatic configuration.

```
multiMapConfig.addEntryListenerConfig(
    new EntryListenerConfig( "com.yourpackage.SampleEntryListener",
        false, false ) );
[source,xml]
```

The following is an example of the equivalent declarative configuration.

```
<hazelcast>
  ...
  <multimap name="somemap">
    <value-collection-type>SET</value-collection-type>
    <entry-listeners>
      <entry-listener include-value="false" local="false">
        com.yourpackage.SampleEntryListener
      </entry-listener>
    </entry-listeners>
  </multimap>
  ...
</hazelcast>
```

The following is an example of the equivalent Spring configuration.

```
<hz:multimap name="somemap" value-collection-type="SET">
  <hz:entry-listeners>
    <hz:entry-listener include-value="false"
      class-name="com.yourpackage.SampleEntryListener"/>
    <hz:entry-listener implementation="EntryListener" local="false"/>
  </hz:entry-listeners>
</hz:multimap>
```

## MultiMap Listener Attributes

As you see, there are attributes of the MultiMap listeners in the above examples: `include-value` and `local`. The attribute `include-value` is a boolean attribute that is optional, and if you set it to `true`, the MultiMap event will contain the map value. Its default value is `true`.

The attribute `local` is also a boolean attribute that is optional, and if you set it to `true`, you can listen to the MultiMap on the local member. Its default value is `false`.

### 8.2.4. Listening for Item Events

The Item Listener is used by the Hazelcast `IQueue`, `ISet` and `IList` interfaces.

To write an Item Listener class, you implement the `ItemListener` interface and its methods `itemAdded` and `itemRemoved`. These methods are invoked when an item is added or removed.

The following is an example Item Listener class for an `ISet` structure.

```
public class SampleItemListener implements ItemListener<Price> {

    @Override
    public void itemAdded(ItemEvent<Price> event) {
        System.out.println( "Item added: " + event );
    }

    @Override
    public void itemRemoved(ItemEvent<Price> event) {
        System.out.println( "Item removed: " + event );
    }
}
```



You can use `ICollection` when creating any of the collection (queue, set and list) data structures, as shown above. You can also use `IQueue`, `ISet` or `IList` instead of `ICollection`.

### Registering Item Listeners

After you create your class, you can configure your cluster to include item listeners. Below is an example using the method `addItemListener` for `ISet` (it applies also to `IQueue` and `IList`). You can also see this portion in the above class creation.

```
HazelcastInstance hazelcastInstance = Hazelcast.newHazelcastInstance();

ICollection<Price> set = hazelcastInstance.getSet( "default" );
// or ISet<Prices> set = hazelcastInstance.getSet( "default" );
set.addItemListener( new SampleItemListener(), true );
```

With the above approach, there is the possibility of missing events between the creation of the

instance and registering the listener. To overcome this race condition, Hazelcast allows you to register listeners in the configuration. You can register listeners using declarative, programmatic, or Spring configuration, as shown below.

The following is an example programmatic configuration.

```
setConfig.addItemListenerConfig(  
    new ItemListenerConfig( "com.yourpackage.SampleItemListener", true ) );
```

The following is an example of the equivalent declarative configuration.

```
<hazelcast>  
  <set>  
    <item-listeners>  
      <item-listener include-value="true">  
        com.yourpackage.SampleItemListener  
      </item-listener>  
    </item-listeners>  
  </set>  
</hazelcast>
```

The following is an example of the equivalent Spring configuration.

```
<hz:set name="default" >  
  <hz:item-listeners>  
    <hz:item-listener include-value="true"  
      class-name="com.yourpackage.SampleItemListener"/>  
  </hz:item-listeners>  
</hz:set>
```

### Item Listener Attributes

As you see, there is an attribute in the above examples: `include-value`. It is a boolean attribute that is optional, and if you set it to `true`, the item event will contain the item value. Its default value is `true`.

There is also another attribute called `local`, which is not shown in the above examples. It is also a boolean attribute that is optional, and if you set it to `true`, you can listen to the items on the local member. Its default value is `false`.

## 8.2.5. Listening for Topic Messages

The Message Listener is used by the `ITopic` interface. It notifies when a message is received for the registered topic.

To write a Message Listener class, you implement the `MessageListener` interface and its method `onMessage`, which is invoked when a message is received for the registered topic.

The following is an example Message Listener class.

```
public class SampleMessageListener implements MessageListener<MyEvent> {  
  
    public void onMessage( Message<MyEvent> message ) {  
        MyEvent myEvent = message.getMessageObject();  
        System.out.println( "Message received = " + myEvent.toString() );  
    }  
}
```

## Registering Message Listeners

After you create your class, you can configure your cluster to include message listeners. Below is an example using the method `addMessageListener`.

```
HazelcastInstance hazelcastInstance = Hazelcast.newHazelcastInstance();  
  
ITopic topic = hazelcastInstance.getTopic( "default" );  
topic.addMessageListener( new SampleMessageListener() );
```

With the above approach, there is the possibility of missing messaging events between the creation of the instance and registering the listener. To overcome this race condition, Hazelcast allows you to register this listener in the configuration. You can register it using declarative, programmatic, or Spring configuration, as shown below.

The following is an example programmatic configuration.

```
topicConfig.addMessageListenerConfig(  
    new ListenerConfig( "com.yourpackage.SampleMessageListener" ) );
```

The following is an example of the equivalent declarative configuration.

```
<hazelcast>  
    ...  
    <topic name="default">  
        <message-listeners>  
            <message-listener>  
                com.yourpackage.SampleMessageListener  
            </message-listener>  
        </message-listeners>  
    </topic>  
    ...  
</hazelcast>
```

The following is an example of the equivalent Spring configuration.

```
<hz:topic name="default">
  <hz:message-listeners>
    <hz:message-listener
      class-name="com.yourpackage.SampleMessageListener"/>
    </hz:message-listeners>
  </hz:topic>
```

## 8.3. Event Listeners for Hazelcast Clients

You can add event listeners to a Hazelcast Java client. You can configure the following listeners to listen to the events on the client side. Please see the respective sections under the [Cluster Events section](#) for example codes.

- [Lifecycle Listener](#): Notifies when the client is starting, started, shutting down and shutdown.
- [Membership Listener](#): Notifies when a member joins to/leaves the cluster to which the client is connected, or when an attribute is changed in a member.
- [DistributedObject Listener](#): Notifies when a distributed object is created or destroyed throughout the cluster to which the client is connected.



Please refer to the [Configuring Client Listeners section](#) for more information.

## 8.4. Global Event Configuration

- `hazelcast.event.queue.capacity`: default value is 1000000
- `hazelcast.event.queue.timeout.millis`: default value is 250
- `hazelcast.event.thread.count`: default value is 5

A striped executor in each cluster member controls and dispatches the received events. This striped executor also guarantees the event order. For all events in Hazelcast, the order in which events are generated and the order in which they are published are guaranteed for given keys. For map and multimap, the order is preserved for the operations on the same key of the entry. For list, set, topic and queue, the order is preserved for events on that instance of the distributed data structure.

To achieve the order guarantee, you make only one thread responsible for a particular set of events (entry events of a key in a map, item events of a collection, etc.) in `StripedExecutor` (within `com.hazelcast.util.executor`).

If the event queue reaches its capacity (`hazelcast.event.queue.capacity`) and the last item cannot be put into the event queue for the period specified in `hazelcast.event.queue.timeout.millis`, these events will be dropped with a warning message, such as "EventQueue overloaded".

If event listeners perform a computation that takes a long time, the event queue can reach its maximum capacity and lose events. For map and multimap, you can configure `hazelcast.event.thread.count` to a higher value so that fewer collisions occur for keys, and therefore worker threads will not block each other in `StripedExecutor`. For list, set, topic and queue,

you should offload heavy work to another thread. To preserve order guarantee, you should implement similar logic with `StripedExecutor` in the offloaded thread pool.

## 9. Hazelcast Jet



This chapter briefly describes Hazelcast Jet. For detailed information and Jet documentation, please visit [jet.hazelcast.org](http://jet.hazelcast.org).

### 9.1. Overview

Hazelcast Jet, built on top of the Hazelcast IMDG, is a distributed processing engine for fast stream and batch processing of large data sets. It reuses the features and services of Hazelcast IMDG, but it is a separate product with features not available in IMDG.

With Hazelcast IMDG providing storage functionality, Jet performs parallel execution in a Hazelcast Jet cluster, composed of Jet instances, to enable data-intensive applications to operate in near real-time. Jet uses green threads (threads that are scheduled by a runtime library or VM) to achieve this parallel execution.

Since Jet uses Hazelcast IMDG's discovery mechanisms, it can be used both on-premises and on the cloud environments. Hazelcast Jet typically runs on several machines that form a cluster.

#### 9.1.1. How You Can Use It

The Pipeline API is the primary high-level API of Hazelcast Jet for batch and stream processing. This API is easy-to-use and set-up providing you with the tools to compose batch computations from building blocks such as filters, aggregators and joiners - saving time and resource. With Pipeline API, you can build bounded and unbounded data pipelines on a variety of sources and sinks.

In addition to the Pipeline API, Jet also offers a distributed implementation of `java.util.stream`. You can express your computation over any data source Jet supports using the familiar API from the JDK 8. This distributed implementation can be used for simple transform and reduce operations on top of `IMap` and `IList`.

There is also Jet's Core API for advanced users to build custom data sources and sinks, to have a low-level control over the data flow, to fine-tune performance and build DSLs.

Please see the [Work with Jet](#) section in the Hazelcast Jet Reference Manual to see a simple example.

#### 9.1.2. Where You Can Use It

Hazelcast Jet is appropriate for applications that require a near real-time experience such as operations in IoT architectures (house thermostats, lighting systems, etc.), in-store e-commerce systems and social media platforms. Typical use cases include the following:

- Real-time (low-latency) stream processing
- Fast batch processing



- Streaming analytics
- Complex event processing
- Implementing event sourcing and CQRS (Command Query Responsibility Segregation)
- Internet-of-things (IoT) data ingestion, processing and storage
- Data processing microservice architectures
- Online trading
- Social media platforms
- System log events

The aforementioned use cases require huge amounts of data to be processed in near real-time. Hazelcast Jet achieves this by processing the incoming records as soon as possible, hence lowering the latency, and ingesting the data at high-velocity. Jet's execution model and keeping both the computation and data storage in memory enables high application speeds.

### 9.1.3. Data Processing Styles

The data processing is traditionally divided into batch and stream processing.

Batch data is considered as bounded, i.e., finite, and fast batch processing typically may refer to running a job on a data set which is available in a data center. You simply provide one or more pre-existing datasets and order Hazelcast Jet to mine them for the information you need.

Stream data is considered as unbounded, i.e., infinite, and infinite stream processing deals with in-flight data before it is stored. It offers lower latency; data is processed on-the-fly and you do not have to wait for the whole data set to arrive in order to run a computation.

## 9.2. Relationship with Hazelcast IMDG

Hazelcast Jet leans on Hazelcast IMDG for cluster management and deployment, data partitioning and networking; all the services of IMDG are available to your Jet Jobs (units of work which are executed). A Jet instance is also a fully functional Hazelcast IMDG instance and a Jet cluster is also a Hazelcast IMDG cluster.

A Jet job is implemented as a Hazelcast IMDG proxy, similar to the other services and data structures in Hazelcast. Hazelcast operations are used for different actions that can be performed on a job. Jet can also be used with the Hazelcast Client, which uses the Hazelcast Open Binary Protocol to communicate different actions to the server instance.

In the Hazelcast Jet world, Hazelcast IMDG can be used for data ingestion prior to processing, connecting multiple Jet jobs, enriching processed events, caching the remote data, distributing Jet-processed data and running advanced data processing tasks on top of IMDG data structures.

Hazelcast Jet can use Hazelcast IMDG's **IMap**, **ICache** and **IList** on the embedded cluster as sources (data structures from which Jet reads data) and sinks (data structures to which Jet writes data). IMap and ICache are partitioned data structures distributed across the cluster and Jet members can read from these structures by having each member read just its local partitions. Hazelcast IMDG's

IList is stored on a single partition; all the data will be read on the single member that owns that partition. Please refer to [IMap and ICache](#) and [IList](#) in the Hazelcast Jet Reference Manual to learn how Jet uses these IMDG data structures. In addition to these data structures, Jet can also process a stream of changes of IMap and ICache, using the [Event Journal](#).

You can use Hazelcast Jet with embedded Hazelcast IMDG or a remote Hazelcast IMDG cluster. Benefits of using Hazelcast Jet with embedded Hazelcast IMDG are as follows:

- Sharing the processing state among Jet Jobs.
- Caching intermediate processing results.
- Enriching processed events; cache remote data, e.g., fact tables from a database, on Jet members.
- Running advanced data processing tasks on top of Hazelcast data structures.
- Improving development processes by making start up of a Jet cluster simple and fast.

Jet Jobs use Hazelcast IMDG connector by allowing reading and writing records to/from a remote Hazelcast IMDG instance. You can use a remote Hazelcast IMDG cluster for the following cases:

- Distributing data across IMap, ICache and IList structures.
- Sharing state or intermediate results among more Jet clusters.
- Isolating the processing cluster (Jet) from operational data storage cluster (IMDG).
- Publishing intermediate results, e.g., to show real-time processing stats on a dashboard.

## 9.3. Hazelcast IMDG Computing vs. Hazelcast Jet

As described in the [Fast-Aggregations section](#) Hazelcast IMDG has native support for aggregation operations on the contents of its distributed data structures.

Fast-Aggregations are a good fit for simple operations (count, distinct, sum, avg, min, max, etc.). However, they may not be sufficient for operations that group data by key and produce the results of size  $O(\text{keyCount})$ . The architecture of Hazelcast aggregations is not well suited to this use case, although it will still work even for moderately sized results (up to 100 MB, as a ballpark figure). Hazelcast Jet can be the preferred choice for larger sized results and whenever something more than a single aggregation step is needed. Please see the [Jet Compared with New Aggregations section](#).

Another Hazelcast IMDG computing feature is [Entry Processors](#). They are used for fast mutating operations in an atomic way, in which the map entry is mutated by executing logic directly on the JVM where the data resides. And this means the network hops are reduced and atomicity is provided in a single step. Keeping this in mind, you can use Hazelcast IMDG Entry Processors when they perform bulk mutations of an IMap, where the processing function is fast and involves a single map entry per call. On the other hand, you can prefer to use Hazelcast Jet when the processing involves multiple entries (aggregations, joins, etc.), or involves multiple computing steps to be made parallel, or when the data source and sink are not a single IMap instance.

# 10. Distributed Computing

This chapter explains Hazelcast's executor service, durable/scheduled executor services and entry processor implementations.

## 10.1. Executor Service

One of the coolest features of Java is the Executor framework, which allows you to asynchronously execute your tasks (logical units of work), such as database queries, complex calculations and image rendering.

The default implementation of this framework (`ThreadPoolExecutor`) is designed to run within a single JVM (cluster member). In distributed systems, this implementation is not desired since you may want a task submitted in one JVM and processed in another one. Hazelcast offers `IExecutorService` for you to use in distributed environments. It implements `java.util.concurrent.ExecutorService` to serve the applications requiring computational and data processing power.



Note that you may want to use [Hazelcast Jet](#) if you want to process batch or real-time streaming data. Please see the [Fast Batch Processing](#) and [Real-Time Stream Processing](#) use cases for Hazelcast Jet.

With `IExecutorService`, you can execute tasks asynchronously and perform other useful tasks. If your task execution takes longer than expected, you can cancel the task execution. Tasks should be `Serializable` since they will be distributed.

In the Java Executor framework, you implement tasks two ways: Callable or Runnable.

- Callable: If you need to return a value and submit it to Executor, implement the task as `java.util.concurrent.Callable`.
- Runnable: If you do not need to return a value, implement the task as `java.util.concurrent.Runnable`.

Note that, the distributed executor service (`IExecutorService`) is intended to run processing where the data is hosted: on the server members. In general, you cannot run a Java Runnable or Callable on the clients as the clients may not be Java. Also, the clients do not host any data, so they would have to fetch what data they need from the servers potentially. If you want something to run on all or some clients connected to your cluster, you could implement this using the publish/subscribe mechanism; a payload could be sent to an `ITopic` with the necessary execution parameters, and clients listening can act on the message.

### 10.1.1. Implementing a Callable Task

In Hazelcast, when you implement a task as `java.util.concurrent.Callable` (a task that returns a value), you implement Callable and Serializable.

Below is an example of a Callable task. SumTask prints out map keys and returns the summed map values.

```
public class SumTask
    implements Callable<Integer>, Serializable, HazelcastInstanceAware {

    private transient HazelcastInstance hazelcastInstance;

    public void setHazelcastInstance( HazelcastInstance hazelcastInstance ) {
        this.hazelcastInstance = hazelcastInstance;
    }

    public Integer call() throws Exception {
        IMap<String, Integer> map = hazelcastInstance.getMap( "map" );
        int result = 0;
        for ( String key : map.localKeySet() ) {
            System.out.println( "Calculating for key: " + key );
            result += map.get( key );
        }
        System.out.println( "Local Result: " + result );
        return result;
    }
}
```

Another example is the Echo callable below. In its call() method, it returns the local member and the input passed in. Remember that `instance.getCluster().getLocalMember()` returns the local member and `toString()` returns the member's address (IP + port) in String form, just to see which member actually executed the code for our example. Of course, the `call()` method can do and return anything you like.

```

public class Echo implements Callable<String>, Serializable, HazelcastInstanceAware {
    String input = null;

    private transient HazelcastInstance hazelcastInstance;

    public Echo() {
    }

    public void setHazelcastInstance( HazelcastInstance hazelcastInstance ) {
        this.hazelcastInstance = hazelcastInstance;
    }

    public Echo(String input) {
        this.input = input;
    }

    public String call() {
        return hazelcastInstance.getCluster().getLocalMember().toString() + ":" +
input;
    }
}

```

## Executing a Callable Task

To execute a callable task:

- Retrieve the Executor from **HazelcastInstance**.
- Submit a task which returns a **Future**.
- After executing the task, you do not have to wait for the execution to complete, you can process other things.
- When ready, use the **Future** object to retrieve the result as shown in the code example below.

Below, the Echo task is executed.

```

public class MasterMember {

    public static void main( String[] args ) throws Exception {
        HazelcastInstance instance = Hazelcast.newHazelcastInstance();
        IExecutorService executorService = instance.getExecutorService(
"executorService" );
        Future<String> future = executorService.submit( new Echo( "myinput" ) );
        //while it is executing, do some useful stuff
        //when ready, get the result of your execution
        String result = future.get();
    }
}

```

Please note that the Echo callable in the above code sample also implements a Serializable interface, since it may be sent to another member to be processed.



When a task is deserialized, HazelcastInstance needs to be accessed. To do this, the task should implement `HazelcastInstanceAware` interface. Please see the [HazelcastInstanceAware Interface section](#) for more information.

### 10.1.2. Implementing a Runnable Task

In Hazelcast, when you implement a task as `java.util.concurrent.runnable` (a task that does not return a value), you implement Runnable and Serializable.

Below is Runnable example code. It is a task that waits for some time and echoes a message.

```
public class EchoTask implements Runnable, Serializable {

    private final String msg;

    public EchoTask( String msg ) {
        this.msg = msg;
    }

    @Override
    public void run() {
        try {
            Thread.sleep( 5000 );
        } catch ( InterruptedException e ) {
        }
        System.out.println( "echo:" + msg );
    }
}
```

#### Executing a Runnable Task

To execute the runnable task:

- Retrieve the Executor from `HazelcastInstance`.
- Submit the tasks to the Executor.

Now let's write a class that submits and executes these echo messages. Executor is retrieved from `HazelcastInstance` and 1000 echo tasks are submitted.

```

public class RunnableMasterMember {

    public static void main( String[] args ) throws Exception {
        HazelcastInstance hazelcastInstance = Hazelcast.newHazelcastInstance();
        IExecutorService executor = hazelcastInstance.getExecutorService( "exec" );
        for ( int k = 1; k <= 1000; k++ ) {
            Thread.sleep( 1000 );
            System.out.println( "Producing echo task: " + k );
            executor.execute( new EchoTask( String.valueOf( k ) ) );
        }
        System.out.println( "EchoTaskMain finished!" );
    }
}

```

### 10.1.3. Scaling The Executor Service

You can scale the Executor service both vertically (scale up) and horizontally (scale out).

To scale up, you should improve the processing capacity of the cluster member (JVM). You can do this by increasing the `pool-size` property mentioned in [Configuring Executor Service](#) (i.e., increasing the thread count). However, please be aware of your member's capacity. If you think it cannot handle such an additional load caused by increasing the thread count, you may want to consider improving the member's resources (CPU, memory, etc.). As an example, set the `pool-size` to 5 and run the above `MasterMember`. You will see that `EchoTask` is run as soon as it is produced.

To scale out, add more members instead of increasing only one member's capacity. In reality, you may want to expand your cluster by adding more physical or virtual machines. For example, in the `EchoTask` example in the [Runnable section](#), you can create another Hazelcast instance. That instance will automatically get involved in the executions started in `MasterMember` and start processing.

### 10.1.4. Executing Code in the Cluster

The distributed executor service is a distributed implementation of `java.util.concurrent.ExecutorService`. It allows you to execute your code in the cluster. In this section, the code examples are based on the [Echo class above](#) (please note that the `Echo` class is `Serializable`). The code examples show how Hazelcast can execute your code (`Runnable`, `Callable`):

- `echoOnTheMember`: On a specific cluster member you choose with the `IExecutorService submitToMember` method.
- `echoOnTheMemberOwningTheKey`: On the member owning the key you choose with the `IExecutorService submitToKeyOwner` method.
- `echoOnSomewhere`: On the member Hazelcast picks with the `IExecutorService submit` method.
- `echoOnMembers`: On all or a subset of the cluster members with the `IExecutorService submitToMembers` method.

```

public void echoOnTheMember( String input, Member member ) throws Exception {
    Callable<String> task = new Echo( input );
    HazelcastInstance hazelcastInstance = Hazelcast.newHazelcastInstance();
    IExecutorService executorService =
        hazelcastInstance.getExecutorService( "default" );

    Future<String> future = executorService.submitToMember( task, member );
    String echoResult = future.get();
}

```

```

public void echoOnTheMemberOwningTheKey( String input, Object key ) throws Exception {
    Callable<String> task = new Echo( input );
    HazelcastInstance hazelcastInstance = Hazelcast.newHazelcastInstance();
    IExecutorService executorService =
        hazelcastInstance.getExecutorService( "default" );

    Future<String> future = executorService.submitToKeyOwner( task, key );
    String echoResult = future.get();
}

```

```

public void echoOnSomewhere( String input ) throws Exception {
    HazelcastInstance hazelcastInstance = Hazelcast.newHazelcastInstance();
    IExecutorService executorService =
        hazelcastInstance.getExecutorService( "default" );

    Future<String> future = executorService.submit( new Echo( input ) );
    String echoResult = future.get();
}

```

```

public void echoOnMembers( String input, Set<Member> members ) throws Exception {
    HazelcastInstance hazelcastInstance = Hazelcast.newHazelcastInstance();
    IExecutorService executorService =
        hazelcastInstance.getExecutorService( "default" );

    Map<Member, Future<String>> futures = executorService
        .submitToMembers( new Echo( input ), members );

    for ( Future<String> future : futures.values() ) {
        String echoResult = future.get();
        // ...
    }
}

```



You can obtain the set of cluster members via `HazelcastInstance.getCluster().getMembers()` call.



### 10.1.5. Canceling an Executing Task

A task in the code that you execute in a cluster might take longer than expected. If you cannot stop/cancel that task, it will keep eating your resources.

To cancel a task, you can use the standard Java executor framework's `cancel()` API. This framework encourages us to code and design for cancellations, a highly ignored part of software development.

#### Example Task to Cancel

The Fibonacci callable class below calculates the Fibonacci number for a given number. In the `calculate` method, we check if the current thread is interrupted so that the code can respond to cancellations once the execution is started.

```
int input = 0;

public FibonacciCallable( int input ) {
    this.input = input;
}

public Long call() {
    return calculate( input );
}

private long calculate( int n ) {
    if ( Thread.currentThread().isInterrupted() ) {
        return 0;
    }
    if ( n <= 1 ) {
        return n;
    } else {
        return calculate( n - 1 ) + calculate( n - 2 );
    }
}
```

#### Example Method to Execute and Cancel the Task

The `fib()` method below submits the Fibonacci calculation task above for number 'n' and waits a maximum of 3 seconds for the result. If the execution does not completed in three seconds, `future.get()` will throw a `TimeoutException` and upon catching it, we cancel the execution, saving some CPU cycles.

```

long fib( int n ) throws Exception {
    HazelcastInstance hazelcastInstance = Hazelcast.newHazelcastInstance();
    IExecutorService es = hazelcastInstance.getExecutorService("es");
    Future<Long> future = es.submit( new FibonacciCallable( n ) );
    try {
        long result = future.get( 3, TimeUnit.SECONDS );
        System.out.println(result);
    } catch ( TimeoutException e ) {
        future.cancel( true );
    }
    return -1;
}

```

`fib(20)` will probably take less than 3 seconds. However, `fib(50)` will take much longer. (This is not an example for writing better Fibonacci calculation code, but for showing how to cancel a running execution that takes too long.) The method `future.cancel(false)` can only cancel execution before it is running (executing), but `future.cancel(true)` can interrupt running executions provided that your code is able to handle the interruption. If you are willing to cancel an already running task, then your task should be designed to handle interruptions. If the `calculate (int n)` method did not have the `(Thread.currentThread().isInterrupted())` line, then you would not be able to cancel the execution after it is started.

### 10.1.6. Callback When Task Completes

You can use the `ExecutionCallback` offered by Hazelcast to asynchronously be notified when the execution is done.

- To be notified when your task completes without an error, implement the `onResponse` method.
- To be notified when your task completes with an error, implement the `onFailure` method.

#### Example Task to Callback

Let's use the Fibonacci series to explain this. The example code below is the calculation that will be executed. Note that it is `Callable` and `Serializable`.

```

public class Fibonacci2 implements Callable<Long>, Serializable {

    private final int input;

    public Fibonacci2(int input) {
        this.input = input;
    }

    public Long call() {
        return calculate(input);
    }

    private long calculate(int n) {
        if (Thread.currentThread().isInterrupted()) {
            System.out.println("FibonacciCallable is interrupted");
            throw new RuntimeException("FibonacciCallable is interrupted");
        }
        if (n <= 1) {
            return n;
        } else {
            return calculate(n - 1) + calculate(n - 2);
        }
    }
}

```

### Example Method to Callback the Task

The example code below submits the Fibonacci calculation to `ExecutionCallback` and prints the result asynchronously. `ExecutionCallback` has the methods `onResponse` and `onFailure`. In this example code, `onResponse` is called upon a valid response and prints the calculation result, whereas `onFailure` is called upon a failure and prints the stacktrace.

```

public class MasterMemberCallback {

    public static void main(String[] args) {
        HazelcastInstance hz = Hazelcast.newHazelcastInstance();
        IExecutorService executor = hz.getExecutorService("executor");

        ExecutionCallback<Long> executionCallback = new ExecutionCallback<Long>() {
            public void onFailure(Throwable t) {
                t.printStackTrace();
            }

            public void onResponse(Long response) {
                System.out.println("Result: " + response);
            }
        };

        executor.submit(new FibonacciCallable(10), executionCallback);
        System.out.println("Fibonacci task submitted");
    }
}

```

### 10.1.7. Selecting Members for Task Execution

As previously mentioned, it is possible to indicate where in the Hazelcast cluster the `Runnable` or `Callable` is executed. Usually you execute these in the cluster based on the location of a key or a set of keys, or you allow Hazelcast to select a member.

If you want more control over where your code runs, use the `MemberSelector` interface. For example, you may want certain tasks to run only on certain members, or you may wish to implement some form of custom load balancing regime. The `MemberSelector` is an interface that you can implement and then provide to the `IExecutorService` when you submit or execute.

The `select(Member)` method is called for every available member in the cluster. Implement this method to decide if the member is going to be used or not.

In a simple example shown below, we select the cluster members based on the presence of an attribute.

```

public class MyMemberSelector implements MemberSelector {
    public boolean select(Member member) {
        return Boolean.TRUE.equals(member.getBooleanAttribute("my.special.executor"));
    }
}

```

You can use `MemberSelector` instances provided by the `com.hazelcast.cluster.memberselector.MemberSelectors` class. For example, you can select a lite member for running a task using `com.hazelcast.cluster.memberselector.MemberSelectors#LITE_MEMBER_SELECTOR`.

## 10.1.8. Configuring Executor Service

The following are example configurations for executor service.

### Declarative:

```
<executor-service name="exec">
  <pool-size>1</pool-size>
  <queue-capacity>10</queue-capacity>
  <statistics-enabled>true</statistics-enabled>
  <quorum-ref>quorumname</quorum-ref>
</executor-service>
```

### Programmatic:

```
Config config = new Config();
ExecutorConfig executorConfig = config.getExecutorConfig("exec");
executorConfig.setPoolSize( 1 ).setQueueCapacity( 10 )
    .setStatisticsEnabled( true )
    .setQuorumName( "quorumname" );
```

Executor service configuration has the following elements.

- **pool-size**: The number of executor threads per Member for the Executor. By default, Executor is configured to have 16 threads in the pool. You can change that with this element.
- **queue-capacity**: Executor's task queue capacity; the number of tasks this queue can hold.
- **statistics-enabled**: You can retrieve some statistics (such as pending operations count, started operations count, completed operations count and cancelled operations count) by setting this parameter's value to **true**. The method for retrieving the statistics is `getLocalExecutorStats()`.
- **quorum-ref**: Name of quorum configuration that you want this Executor Service to use. Please see the [Split-Brain Protection for IExecutorService](#) section.

## 10.1.9. Split-Brain Protection for IExecutorService

IExecutorService can be configured to check for a minimum number of available members before applying its operations (see [Split-Brain Protection](#)). This is a check to avoid performing successful queue operations on all parts of a cluster during a network partition.

Following is a list of methods that now support Split-Brain Protection checks. The list is grouped by quorum type.

- WRITE, READ\_WRITE:
  - `execute`
  - `executeOnAllMembers`
  - `executeOnKeyOwner`
  - `executeOnMember`

- `executeOnMembers`
- `shutdown`
- `shutdownNow`
- `submit`
- `submitToAllMembers`
- `submitToKeyOwner`
- `submitToMember`
- `submitToMembers`

## Configuring Split-Brain Protection

Split-Brain protection for Executor Service can be configured programmatically using the method `setQuorumName()`, or declaratively using the element `quorum-ref`. Following is an example declarative configuration:

```
<executor-service name="default">
  ...
  <quorum-ref>quorumname</quorum-ref>
  ...
</executor-service>
```

The value of `quorum-ref` should be the quorum configuration name which you configured under the `quorum` element as explained in the [Split-Brain Protection section](#).

## 10.2. Durable Executor Service

Hazelcast's durable executor service is a data structure which is able to store an execution task both on the executing Hazelcast member and its backup member(s), if configured. By this way, you do not lose any tasks if a member goes down or any results if the submitter (member or client) goes down while executing the task. When using the durable executor service you can either submit or execute a task randomly or on the owner of a provided key. Note that in [executor service](#), you can submit or execute tasks to/on the selected member(s).

Processing of the tasks when using durable executor service involves two invocations:

1. Sending the task to primary Hazelcast member (primary partition) and to its backups, if configured, and executing the task.
2. Retrieving the result of the task.

As you may already know, Hazelcast's executor service returns a `future` representing the task to the user. With the above two-investigations approach, it is guaranteed that the task is executed before the `future` returns and you can track the response of a submitted task with a unique ID. Hazelcast stores the task on both primary and backup members, and starts the execution also.

With the first invocation, a [Ringbuffer](#) stores the task and a generated sequence for the task is returned to the caller as a result. In addition to the storing, the task is executed on the local execution service for the primary member. By this way, the task is now resilient to member failures

and you are able to track the task with its ID.

After the first invocation has completed and the sequence of task is returned, second invocation starts to retrieve the result of task with that sequence. This retrieval waits in the waiting operations queue until notified, or it runs immediately if the result is already available.

When task execution is completed, Ringbuffer replaces the task with the result for the given task sequence. This replacement notifies the waiting operations queue.

### 10.2.1. Configuring Durable Executor Service

This section presents example configurations for durable executor service along with the descriptions of its configuration elements and attributes.

#### Declarative:

```
<durable-executor-service name="myDurableExecSvc">
  <pool-size>8</pool-size>
  <durability>1</durability>
  <capacity>1</capacity>
  <quorum-ref>quorumname</quorum-ref>
</durable-executor-service>
```

#### Programmatic:

```
Config config = new Config();
config.getDurableExecutorConfig( "myDurableExecSvc" )
    .setPoolSize ( 8 )
    .setDurability( 1 )
    .setCapacity( 1 )
    .setQuorumName( "quorumname" );

HazelcastInstance hazelcast = Hazelcast.newHazelcastInstance(config);
DurableExecutorService durableExecSvc = hazelcast.getDurableExecutorService(
    "myDurableExecSvc");
```

Following are the descriptions of each configuration element and attribute:

- **name**: Name of the executor task.
- **pool-size**: Number of executor threads per member for the executor.
- **durability**: Number of backups in the cluster for the submitted task. Its default value is 1.
- **capacity**: Executor's task queue capacity; the number of tasks this queue can hold.
- **quorum-ref**: Name of quorum configuration that you want this Durable Executor Service to use. Please see the [Split-Brain Protection for Durable Executor Service section](#).

## 10.2.2. Split-Brain Protection for Durable Executor Service

Durable Executor Service can be configured to check for a minimum number of available members before applying its operations (see [Split-Brain Protection](#)). This is a check to avoid performing successful queue operations on all parts of a cluster during a network partition.

Following is a list of methods that now support Split-Brain Protection checks. The list is grouped by quorum type.

- WRITE, READ\_WRITE:
  - `disposeResult`
  - `execute`
  - `executeOnKeyOwner`
  - `retrieveAndDisposeResult`
  - `shutdown`
  - `shutdownNow`
  - `submit`
  - `submitToKeyOwner`
- READ, READ\_WRITE:
  - `retrieveResult`

### Configuring Split-Brain Protection

Split-Brain protection for Durable Executor Service can be configured programmatically using the method `setQuorumName()`, or declaratively using the element `quorum-ref`. Following is an example declarative configuration:

```
< durable-executor-service name="myDurableExecSvc">
  ...
  < quorum-ref>quorumname</ quorum-ref>
  ...
</ durable-executor-service>
```

The value of `quorum-ref` should be the quorum configuration name which you configured under the `quorum` element as explained in the [Split-Brain Protection section](#).

## 10.3. Scheduled Executor Service

Hazelcast's scheduled executor service (`IScheduledExecutorService`) is a data structure which implements the `java.util.concurrent.ScheduledExecutorService`, partially. Here, partially means that it allows the scheduling of a single future execution and/or at a fixed rate execution but not at a fixed delay.

On top of the Vanilla Scheduling API, `IScheduledExecutorService` allows additional methods such as the following:

- `scheduleOnMember`: On a specific cluster member.



- `scheduleOnKeyOwner`: On the partition owning that key.
- `scheduleOnAllMembers`: On all cluster members.
- `scheduleOnAllMembers`: On all given members.

Please refer to the [IScheduledExecutorService Javadoc](#) for its API details.

There are two different modes of durability for the service:

1. Upon partition specific scheduling, the future task is stored both in the primary partition and also in its N backups, N being the `<durability>` property in the configuration. More specifically, there are always one or more backups to take ownership of the task in the event of a lost member. If a member is lost, the task will be re-scheduled on the backup (new primary) member, which might induce further delays on the subsequent executions of the task. For example, if we schedule a task to run in 10 seconds from now, `schedule(new ExampleTask(), 10, TimeUnit.SECONDS)`; and after 5 seconds the owner member goes down (before the execution takes place), then the backup owner will re-schedule the task in 10 seconds from now. Therefore, from the user's perspective waiting on the result, this will be available in  $10 + 5 = 15$  seconds rather than 10 seconds as it is anticipated originally. If `atFixedRate` was used, then only the initial delay is affected in the above scenario, all subsequent executions should adhere to the given period parameter.
2. Upon member specific scheduling, the future task is **only** stored in the member itself, which means that in the event of a lost member, the task will be lost as well.

To accomplish the described durability, all tasks provide a unique identity/name before the scheduling takes place. The name allows the service to reach the scheduled task even after the caller (client or member) goes down and also allows to prevent duplicate tasks. The name of the task can be user-defined if it needs to be, by implementing the `com.hazelcast.scheduledexecutor.NamedTask` interface (plain wrapper util is available here: `com.hazelcast.scheduledexecutor.TaskUtils.named(java.lang.String, java.lang.Runnable)`). If the task does not provide a name in its implementation, the service provides a random UUID for it, internally.

Upon scheduling, the service returns an `IScheduledFuture`, which on top of the `java.util.concurrent.ScheduledFuture` functionality, provides an API to get the resource handler of the task `ScheduledTaskHandler` and also the runtime statistics of the task.

Futures associated with a scheduled task, in order to be aware of lost partitions and/or members, act as listeners on the local member/client. Therefore, they are always strongly referenced, on the member/client side. In order to clean up their resources, once completed, you can use the method `dispose()`. This method will also cancel further executions of the task if scheduled at fixed rate. You can refer to the [IScheduledFuture Javadoc](#) for its API details.

The task handler is a descriptor class holding information for the scheduled future, which is used to pinpoint the actual task in the cluster. It contains the name of the task, the owner (member or partition) and the scheduler name.

The handler is always available after scheduling and can be stored in a plain string format `com.hazelcast.scheduledexecutor.ScheduledTaskHandler.toUrn()` and re-constructed back from that

String `com.hazelcast.scheduledexecutor.ScheduledTaskHandler.of()`. If the handler is lost, you can still find a task under a given scheduler by using the Scheduler's `com.hazelcast.scheduledexecutor.IScheduledExecutorService.getAllScheduledFutures()`.

Last but not least, similar to [executor service](#), the scheduled executor service allows Stateful tasks to be scheduled. Stateful tasks, are tasks that require any kind of state during their runtime, which must also be durable along with the task in the event of a lost partition.

Stateful tasks can be created by implementing the `com.hazelcast.scheduledexecutor.StatefulTask` interface, providing implementation details for saving the state and loading it back. If a partition is lost, then the re-scheduled task will load the previously saved state before its execution.



As with the tasks, Objects stored in the state Map need to be Hazelcast serializable.

### 10.3.1. Configuring Scheduled Executor Service

This section presents example configurations for scheduled executor service along with the descriptions of its configuration elements and attributes.

#### Declarative:

```
<scheduled-executor-service name="myScheduledExecSvc">
  <pool-size>16</pool-size>
  <durability>1</durability>
  <capacity>100</capacity>
  <quorum-ref>quorumname</quorum-ref>
</scheduled-executor-service>
```

#### Programmatic:

```
Config config = new Config();
config.getScheduledExecutorConfig( "myScheduledExecSvc" )
    .setPoolSize ( 16 )
    .setCapacity( 100 )
    .setDurability( 1 )
    .setQuorumName( "quorumname" );

HazelcastInstance hazelcast = Hazelcast.newHazelcastInstance(config);
IScheduledExecutorService myScheduledExecSvc = hazelcast.getScheduledExecutorService(
    "myScheduledExecSvc");
```

Following are the descriptions of each configuration element and attribute:

- **name**: Name of the scheduled executor.
- **pool-size**: Number of executor threads per member for the executor.
- **capacity**: Maximum number of tasks that a scheduler can have per partition. Attempt to schedule more, will result in `RejectedExecutionException`. To free up the capacity, tasks should

get disposed by the user.

- **durability**: Durability of the executor.
- **quorum-ref**: Name of quorum configuration that you want this Scheduled Executor Service to use. Please see the [Split-Brain Protection for IScheduled Executor Service](#) section.

### 10.3.2. Examples

Scheduling a callable that computes the cluster size in **10 seconds** from now:

```
static class DelayedClusterSizeTask implements Callable<Integer>,
HazelcastInstanceAware, Serializable {

    private transient HazelcastInstance instance;

    @Override
    public Integer call()
        throws Exception {
        return instance.getCluster().getMembers().size();
    }

    @Override
    public void setHazelcastInstance(HazelcastInstance hazelcastInstance) {
        this.instance = hazelcastInstance;
    }
}

HazelcastInstance hazelcast = Hazelcast.newHazelcastInstance();
IScheduledExecutorService executorService = hazelcast.getScheduledExecutorService(
    "myScheduler");
IScheduledFuture<Integer> future = executorService.schedule(
    new DelayedClusterSizeTask(), 10, TimeUnit.SECONDS);

int membersCount = future.get(); // Block until we get the result
ScheduledTaskStatistics stats = future.getStats();
future.dispose(); // Always dispose futures that are not in use any more, to release
resources
long totalTaskRuns = stats.getTotalRuns(); // = 1
```

### 10.3.3. Split-Brain Protection for IScheduled Executor Service

IScheduledExecutorService can be configured to check for a minimum number of available members before applying its operations (see [Split-Brain Protection](#)). This is a check to avoid performing successful queue operations on all parts of a cluster during a network partition.

Following is a list of methods that now support Split-Brain Protection checks. The list is grouped by quorum type.

- WRITE, READ\_WRITE:

- `schedule`
- `scheduleAtFixedRate`
- `scheduleOnAllMembers`
- `scheduleOnAllMembersAtFixedRate`
- `scheduleOnKeyOwner`
- `scheduleOnKeyOwnerAtFixedRate`
- `scheduleOnMember`
- `scheduleOnMemberAtFixedRate`
- `scheduleOnMembers`
- `scheduleOnMembersAtFixedRate`
- `shutdown`
- `READ, READ_WRITE`:
  - `getAllScheduledFutures`

### Configuring Split-Brain Protection

Split-Brain protection for Scheduled Executor Service can be configured programmatically using the method `setQuorumName()`, or declaratively using the element `quorum-ref`. Following is an example declarative configuration:

```
<scheduled-executor-service name="myScheduledExecSvc">
  ...
  <quorum-ref>quorumname</quorum-ref>
  ...
</scheduled-executor-service>
```

The value of `quorum-ref` should be the quorum configuration name which you configured under the `quorum` element as explained in the [Split-Brain Protection section](#).

## 10.4. Entry Processor

Hazelcast supports entry processing. An entry processor is a function that executes your code on a map entry in an atomic way.

An entry processor is a good option if you perform bulk processing on an `IMap`. Usually you perform a loop of keys - executing `IMap.get(key)`, mutating the value and finally putting the entry back in the map using `IMap.put(key, value)`. If you perform this process from a client or from a member where the keys do not exist, you effectively perform two network hops for each update: the first to retrieve the data and the second to update the mutated value.

If you are doing the process described above, you should consider using entry processors. An entry processor executes a read and updates upon the member where the data resides. This eliminates the costly network hops described above.



Entry processor is meant to process a single entry per call. Processing multiple entries and data structures in an entry processor is not supported as it may result in deadlocks.



Note that Hazelcast Jet is a good fit when you want to perform processing that involves multiple entries (aggregations, joins, etc.), or involves multiple computing steps to be made parallel. Hazelcast Jet contains an Entry Processor Sink to allow you to update Hazelcast IMDG data as a result of your Hazelcast Jet computation. Please refer to [Hazelcast Jet's Reference Manual](#).

### 10.4.1. Performing Fast In-Memory Map Operations

An entry processor enables fast in-memory operations on your map without you having to worry about locks or concurrency issues. You can apply it to a single map entry or to all map entries. Entry processors support choosing target entries using predicates. You do not need any explicit lock on entry thanks to the isolated threading model: Hazelcast runs the entry processor for all entries on a `partitionThread` so there will NOT be any interleaving of the entry processor and other mutations.

Hazelcast sends the entry processor to each cluster member and these members apply it to map entries. Therefore, if you add more members, your processing completes faster.

#### Using Indexes

Entry processors can be used with predicates. Predicates help to process a subset of data by selecting eligible entries. This selection can happen either by doing a full-table scan or by using indexes. To accelerate entry selection step, you can consider to add indexes. If indexes are there, entry processor will automatically use them.

#### Using OBJECT In-Memory Format

If entry processing is the major operation for a map and if the map consists of complex objects, you should use `OBJECT` as the `in-memory-format` to minimize serialization cost. By default, the entry value is stored as a byte array (`BINARY` format). When it is stored as an object (`OBJECT` format), then the entry processor is applied directly on the object. In that case, no serialization or deserialization is performed. However, if there is a defined event listener, a new entry value will be serialized when passing to the event publisher service.



When `in-memory-format` is `OBJECT`, the old value of the updated entry will be null.

#### Processing Entries

The methods below are in the [IMap interface](#) for entry processing.

- `executeOnKey` processes an entry mapped by a key.
- `executeOnKeys` processes entries mapped by a collection of keys.
- `submitToKey` processes an entry mapped by a key while listening to event status.
- `executeOnEntries` processes all entries in a map.

- `executeOnEntries` can also process all entries in a map with a defined predicate.

When using the `executeOnEntries` method, if the number of entries is high and you need the results, then returning null with the `process()` method is a good practice. This method is offered by the `EntryProcessor` interface. By returning null, results of the processing is not stored in the map and thus out of memory errors are eliminated.

If you want to execute a task on a single key, you can also use `executeOnKeyOwner` provided by `IExecutorService`. However, in this case you need to perform a lock and serialization.



Entry processors run via Operation Threads that are dedicated to specific partitions. Therefore, with long running entry processor executions, other partition operations such as `map.put(key)` cannot be processed. With this in mind, it is a good practice to make your entry processor executions as quick as possible.

### Respecting Locks on Single Keys

The entry processor respects locks ONLY when its executions are performed on a single key. As explained in the above section, the entry processor has the following methods to process a single key:

```
Object executeOnKey(K key, EntryProcessor entryProcessor);
CompletableFuture submitToKey(K key, EntryProcessor entryProcessor);
```

Therefore, if you want to perform an entry processor execution on a single key using one of these methods and that key has a lock on it, the execution will wait until the lock on that key is removed.

### Processing Backup Entries

If your code modifies the data, then you should also provide a processor for backup entries. This is required to prevent the primary map entries from having different values than the backups because it causes the entry processor to be applied both on the primary and backup entries. The interface `EntryBackupProcessor` offers the method `processBackup` for this purpose.



It is possible that an entry processor could see that a key exists though its backup processor may not find it at the run time due to an unsent backup of a previous operation, e.g., a previous `put` operation. In those situations, Hazelcast internally/eventually will synchronize those owner and backup partitions so you will not lose any data. When coding an `EntryBackupProcessor`, you should take that case into account, otherwise `NullPointerException` can be seen since `Map.Entry.getValue()` may return null.

## 10.4.2. Creating an Entry Processor

The class `IncrementingEntryProcessor` creates an entry processor to process the map entries. It implements:

- the map interfaces `EntryProcessor` and `EntryBackupProcessor`.

- `java.io.Serializable` interface.
- `EntryProcessor` methods `process` and `getBackupProcessor`.
- `EntryBackupProcessor` method `processBackup`.

```
public class IncrementingEntryProcessor
    implements EntryProcessor<Integer, Integer>, EntryBackupProcessor<Integer,
Integer>, Serializable {

    public Object process( Map.Entry<Integer, Integer> entry ) {
        Integer value = entry.getValue();
        entry.setValue( value + 1 );
        return value + 1;
    }

    public EntryBackupProcessor<Integer, Integer> getBackupProcessor() {
        return IncrementingEntryProcessor.this;
    }

    public void processBackup( Map.Entry<Integer, Integer> entry ) {
        entry.setValue( entry.getValue() + 1 );
    }
}
```

A sample usage is shown below:

```
IMap<Integer, Integer> map = hazelcastInstance.getMap( "myMap" );
for ( int i = 0; i < 100; i++ ) {
    map.put( i, i );
}
Map<Integer, Object> res = map.executeOnEntries( new IncrementingEntryProcessor() );
```



You should explicitly call the `setValue` method of `Map.Entry` when modifying data in the entry processor. Otherwise, the entry processor will be accepted as read-only.



An entry processor instance is not thread safe. If you are storing a partition specific state between invocations, be sure to register this in a thread-local. An entry processor instance can be used by multiple partition threads.

### 10.4.3. Abstract Entry Processor

You can use the `AbstractEntryProcessor` class when the same processing will be performed both on the primary and backup map entries, i.e., the same logic applies to them. If you use entry processor, you need to apply the same logic to the backup entries separately. The `AbstractEntryProcessor` class makes this primary/backup processing easier.

You can use the `AbstractEntryProcessor` class to create your own abstract entry processor. The

method `getBackupProcessor` in this class returns an `EntryBackupProcessor` instance. This means the same processing will be applied to both the primary and backup entries. If you want to apply the processing only upon the primary entries, make the `getBackupProcessor` method return null.



Beware of the null issue described above. Due to a yet unsent backup from a previous operation, an `EntryBackupProcessor` may temporarily receive `null` from `Map.Entry.getValue()` even though the value actually exists in the map. If you decide to use `AbstractEntryProcessor`, make sure your code logic is not sensitive to null values, or you may encounter `NullPointerException` during runtime.

#### 10.4.4. Entry Processor Performance Optimizations

By default the entry processor executes on a partition thread. A partition thread is responsible for handling one or more partitions. The design of entry processor assumes users have fast user code execution of the `process()` method. In the pathological case where the code is very heavy and executes in multi-milliseconds, this may create a bottleneck.

We have a slow user code detector which can be used to log a warning controlled by the following system properties:

- `hazelcast.slow.operation.detector.enabled` (default: true)
- `hazelcast.slow.operation.detector.threshold.millis` (default: 10000)

The defaults catch extremely slow operations but you should set this much lower, say to 1ms, at development time to catch entry processors that could be problematic in production. These are good candidates for our optimizations.

We have two optimizations:

- `Offloadable` which moves execution off the partition thread to an executor thread
- `ReadOnly` which means we can avoid taking a lock on the key

These are enabled very simply by implementing these interfaces in your `EntryProcessor`.

As of 3.9, these optimizations apply to the following `IMap` methods only:

- `executeOnKey(Object, EntryProcessor)`
- `submitToKey(Object, EntryProcessor)`
- `submitToKey(Object, EntryProcessor, ExecutionCallback)`

#### Offloadable Entry Processor

If an entry processor implements the `Offloadable` interface, the `process()` method will be executed in the executor specified by the `Offloadable`'s `getExecutorName()` method.

Offloading will unblock the partition thread allowing the user to profit from much higher throughput. The key will be locked for the time span of the processing in order to not generate a write conflict.



In this case the threading looks as follows:

1. partition thread (fetch entry & lock key)
2. execution thread (process(entry) method)
3. partition thread (set new value & unlock key, or just unlock key if the entry has not been modified)

The method `getExecutorName()` method may also return two constants defined in the [Offloadable interface](#):

- `NO_OFFLOADING`: Processing will not be offloaded if the method `getExecutorName()` returns this constant; it will be executed as if it does not implement the `Offloadable` interface.
- `OFFLOADABLE_EXECUTOR`: Processing will be offloaded to the default `ExecutionService.OFFLOADABLE_EXECUTOR`.

Note that if the method `getExecutorName()` cannot find an executor whose name matches the one called by this method, then the default executor service is used. Here is the configuration for the "default" executor:

```
<executor-service name="default">
  <pool-size>16</pool-size>
  <queue-capacity>0</queue-capacity>
</executor-service>
```

An example of an `Offloadable` called "OffloadedInventoryEntryProcessor" would be as follows:

```
<executor-service name="OffloadedInventoryEntryProcessor">
  <pool-size>30</pool-size>
  <queue-capacity>0</queue-capacity>
</executor-service>
```

Remember to set the `pool-size` (count of executor threads per member) according to your execution needs. Please refer to the [Configuring Executor Service section](#) for the configuration details.

### ReadOnly Entry Processor

By default, an entry processor will not run if the key is locked. It will wait until the key has been unlocked (it applies to the `executeOnKey`, `submitToKey` methods, that were mentioned before).

If the entry processor implements the `ReadOnly` interface without implementing the `Offloadable` interface, the processing will not be offloaded to an external executor. However, the entry processor will not observe if the key of the processed entry is locked, nor will try to acquire the lock since the entry processor will not do any modifications.

If the entry processor implements `ReadOnly` and modifies the entry, an `UnsupportedOperationException` will be thrown.

## ReadOnly and Offloadable Entry Processor

If the entry processor implements both `ReadOnly` and `Offloadable` interfaces, we will observe the combination of both optimizations described above.

The `process()` method will be executed in the executor specified by the `Offloadable`'s `getExecutorName()` method. Also, the entry processor will not observe if the key of the processed entry is locked, nor will try to acquire the lock since the entry processor will not do any modifications.

In this case the threading looks as follows:

1. partition thread (fetch entry)
2. execution thread (process(entry))

In this case the `EntryProcessor.getBackupProcessor()` has to return null; otherwise an `IllegalArgumentException` exception is thrown.

If the entry processor implements `ReadOnly` and modifies the entry, an `UnsupportedOperationException` will be thrown.

Putting it all together:

```
public class OffloadableReadOnlyEntryProcessor implements EntryProcessor<String,
Employee>,
    Offloadable, ReadOnly {

    @Override
    public Object process(Map.Entry<String, Employee> entry) {
        // heavy logic
        return null;
    }

    @Override
    public EntryBackupProcessor<String, Employee> getBackupProcessor() {
        // ReadOnly EntryProcessor has to return null, since it's just a read-only
operation that will not be
        // executed on the backup
        return null;
    }

    @Override
    public String getExecutorName() {
        return OFFLOADABLE_EXECUTOR;
    }
}
```

# 11. Distributed Query

Distributed queries access data from multiple data sources stored on either the same or different members.

Hazelcast partitions your data and spreads it across cluster of members. You can iterate over the map entries and look for certain entries (specified by predicates) you are interested in. However, this is not very efficient because you will have to bring the entire entry set and iterate locally. Instead, Hazelcast allows you to run distributed queries on your distributed map.

## 11.1. How Distributed Query Works

1. The requested predicate is sent to each member in the cluster.
2. Each member looks at its own local entries and filters them according to the predicate. At this stage, key/value pairs of the entries are deserialized and then passed to the predicate.
3. The predicate requester merges all the results coming from each member into a single set.

Distributed query is highly scalable. If you add new members to the cluster, the partition count for each member is reduced and thus the time spent by each member on iterating its entries is reduced. In addition, the pool of partition threads evaluates the entries concurrently in each member and the network traffic is also reduced since only filtered data is sent to the requester.

Hazelcast offers the following APIs for distributed query purposes:

- Criteria API
- Distributed SQL Query

### 11.1.1. Employee Map Query Example

Assume that you have an "employee" map containing values of `Employee` objects, as coded below.

```

public class Employee implements Serializable {
    private String name;
    private int age;
    private boolean active;
    private double salary;

    public Employee(String name, int age, boolean active, double salary) {
        this.name = name;
        this.age = age;
        this.active = active;
        this.salary = salary;
    }

    public Employee() {
    }

    public String getName() {
        return name;
    }

    public int getAge() {
        return age;
    }

    public double getSalary() {
        return salary;
    }

    public boolean isActive() {
        return active;
    }
}

```

Now let's look for the employees who are active and have an age less than 30 using the aforementioned APIs (Criteria API and Distributed SQL Query). The following subsections describe each query mechanism for this example.



When using Portable objects, if one field of an object exists on one member but does not exist on another one, Hazelcast does not throw an unknown field exception. Instead, Hazelcast treats that predicate, which tries to perform a query on an unknown field, as an always false predicate.

### 11.1.2. Querying with Criteria API

Criteria API is a programming interface offered by Hazelcast that is similar to the Java Persistence Query Language (JPQL). Below is the code for the [above example query](#).

```
IMap<String, Employee> map = hazelcastInstance.getMap( "employee" );

EntryObject e = new PredicateBuilder().getEntryObject();
Predicate predicate = e.is( "active" ).and( e.get( "age" ).lessThan( 30 ) );

Collection<Employee> employees = map.values( predicate );
```

In the above example code, `predicate` verifies whether the entry is active and its `age` value is less than 30. This `predicate` is applied to the `employee` map using the `map.values(predicate)` method. This method sends the predicate to all cluster members and merges the results coming from them. Since the predicate is communicated between the members, it needs to be serializable.



Predicates can also be applied to `keySet`, `entrySet` and `localKeySet` of the Hazelcast distributed map.

### Predicates Class Operators

The `Predicates` class offered by Hazelcast includes many operators for your query requirements. Some of them are explained below.

- `equal`: Checks if the result of an expression is equal to a given value.
- `notEqual`: Checks if the result of an expression is not equal to a given value.
- `instanceOf`: Checks if the result of an expression has a certain type.
- `like`: Checks if the result of an expression matches some string pattern. % (percentage sign) is the placeholder for many characters, (underscore) is placeholder for only one character.
- `greaterThan`: Checks if the result of an expression is greater than a certain value.
- `greaterEqual`: Checks if the result of an expression is greater than or equal to a certain value.
- `lessThan`: Checks if the result of an expression is less than a certain value.
- `lessEqual`: Checks if the result of an expression is less than or equal to a certain value.
- `between`: Checks if the result of an expression is between two values (this is inclusive).
- `in`: Checks if the result of an expression is an element of a certain collection.
- `isNot`: Checks if the result of an expression is false.
- `regex`: Checks if the result of an expression matches some regular expression.



Please see the [Predicates Javadoc](#) for all predicates provided.

### Combining Predicates with AND, OR, NOT

You can combine predicates using the `and`, `or` and `not` operators, as shown in the below examples.

```

public Collection<Employee> getWithNameAndAge( String name, int age ) {
    Predicate namePredicate = Predicates.equal( "name", name );
    Predicate agePredicate = Predicates.equal( "age", age );
    Predicate predicate = Predicates.and( namePredicate, agePredicate );
    return employeeMap.values( predicate );
}

```

```

public Collection<Employee> getWithNameOrAge( String name, int age ) {
    Predicate namePredicate = Predicates.equal( "name", name );
    Predicate agePredicate = Predicates.equal( "age", age );
    Predicate predicate = Predicates.or( namePredicate, agePredicate );
    return employeeMap.values( predicate );
}

```

```

public Collection<Employee> getNotWithName( String name ) {
    Predicate namePredicate = Predicates.equal( "name", name );
    Predicate predicate = Predicates.not( namePredicate );
    return employeeMap.values( predicate );
}

```

### Simplifying with PredicateBuilder

You can simplify predicate usage with the `PredicateBuilder` class, which offers simpler predicate building. Please see the below example code which selects all people with a certain name and age.

```

public Collection<Employee> getWithNameAndAgeSimplified( String name, int age ) {
    EntryObject e = new PredicateBuilder().getEntryObject();
    Predicate agePredicate = e.get( "age" ).equal( age );
    Predicate predicate = e.get( "name" ).equal( name ).and( agePredicate );
    return employeeMap.values( predicate );
}

```

### 11.1.3. Querying with SQL

`com.hazelcast.query.SqlPredicate` takes the regular SQL `where` clause. Here is an example:

```

IMap<String, Employee> map = hazelcastInstance.getMap( "employee" );
Set<Employee> employees = map.values( new SqlPredicate( "active AND age < 30" ) );

```

#### Supported SQL Syntax

**AND/OR:** `<expression> AND <expression> AND <expression>...``

- `active AND age>30`

- active=false OR age = 45 OR name = 'Joe'
- active AND ( age > 20 OR salary < 60000 )

**Equality:** =, !=, <, <=, >, >=

- <expression> = value
- age <= 30
- name = 'Joe'
- salary != 50000

**BETWEEN:** <attribute> [NOT] BETWEEN <value1> AND <value2>

- age BETWEEN 20 AND 33 ( same as age >= 20 AND age <= 33 )
- age NOT BETWEEN 30 AND 40 ( same as age < 30 OR age > 40 )

**IN:** <attribute> [NOT] IN (val1, val2,...)

- age IN ( 20, 30, 40 )
- age NOT IN ( 60, 70 )
- active AND ( salary >= 50000 OR ( age NOT BETWEEN 20 AND 30 ) )
- age IN ( 20, 30, 40 ) AND salary BETWEEN ( 50000, 80000 )

**LIKE:** <attribute> [NOT] LIKE "expression"

The % (percentage sign) is placeholder for multiple characters, an \_ (underscore) is placeholder for only one character.

- name LIKE 'Jo%' (true for 'Joe', 'Josh', 'Joseph' etc.)
- name LIKE 'Jo\_' (true for 'Joe'; false for 'Josh')
- name NOT LIKE 'Jo\_' (true for 'Josh'; false for 'Joe')
- name LIKE 'J\_s%' (true for 'Josh', 'Joseph'; false 'John', 'Joe')

**ILIKE:** <attribute> [NOT] ILIKE 'expression'

Similar to LIKE predicate but in a case-insensitive manner.

- name ILIKE 'Jo%' (true for 'Joe', 'joe', 'jOe', 'Josh', 'joSH', etc.)
- name ILIKE 'Jo\_' (true for 'Joe' or 'jOE'; false for 'Josh')

**REGEX:** <attribute> [NOT] REGEX 'expression'

- name REGEX 'abc-.\*' (true for 'abc-123'; false for 'abx-123')

## Querying Entry Keys with Predicates

You can use `__key` attribute to perform a predicated search for entry keys. Please see the following example:

```

IMap<String, Person> personMap = hazelcastInstance.getMap(persons);
personMap.put("Alice", new Person("Alice", 35, Gender.FEMALE));
personMap.put("Andy", new Person("Andy", 37, Gender.MALE));
personMap.put("Bob", new Person("Bob", 22, Gender.MALE));
[...]
Predicate predicate = new SqlPredicate("__key like A%");
Collection<Person> startingWithA = personMap.values(predicate);

```

In this example, the code creates a collection with the entries whose keys start with the letter "A".

### 11.1.4. Filtering with Paging Predicates

Hazelcast provides paging for defined predicates. With its `PagingPredicate` class, you can get a collection of keys, values, or entries page by page by filtering them with predicates and giving the size of the pages. Also, you can sort the entries by specifying comparators.

In the example code below:

- The `greaterEqual` predicate gets values from the "students" map. This predicate has a filter to retrieve the objects with an "age" greater than or equal to 18.
- Then a `PagingPredicate` is constructed in which the page size is 5, so there will be five objects in each page. The first time the values are called creates the first page.
- It gets subsequent pages with the `nextPage()` method of `PagingPredicate` and querying the map again with the updated `PagingPredicate`.

```

IMap<Integer, Student> map = hazelcastInstance.getMap( "students" );
Predicate greaterEqual = Predicates.greaterEqual( "age", 18 );
PagingPredicate pagingPredicate = new PagingPredicate( greaterEqual, 5 );
// Retrieve the first page
Collection<Student> values = map.values( pagingPredicate );
...
// Set up next page
pagingPredicate.nextPage();
// Retrieve next page
values = map.values( pagingPredicate );
...

```

If a comparator is not specified for `PagingPredicate`, but you want to get a collection of keys or values page by page, this collection must be an instance of `Comparable` (i.e., it must implement `java.lang.Comparable`). Otherwise, the `java.lang.IllegalArgumentException` exception is thrown.

Starting with Hazelcast 3.6, you can also access a specific page more easily with the help of the method `setPage()`. This way, if you make a query for the hundredth page, for example, it will get all 100 pages at once instead of reaching the hundredth page one by one using the method `nextPage()`. Please note that this feature tires the memory and refer to the [PagingPredicate Javadoc](#).

Paging Predicate, also known as Order & Limit, is not supported in Transactional Context.



### 11.1.5. Filtering with Partition Predicate

You can run queries on a single partition in your cluster using the partition predicate (`PartitionPredicate`).

It takes a predicate and partition key as parameters, gets the partition ID using the key and runs that predicate only on the partition where that key belongs.

Please see the following code snippet:

```
...
Predicate predicate = new PartitionPredicate<String, Integer>(partitionKey,
TruePredicate.INSTANCE);

Collection<Integer> values = map.values(predicate);
Collection<String> keys = map.keySet(predicate);
...
```

By default there are 271 partitions, and using a regular predicate, each partition needs to be accessed. However, if the partition predicate will only access a single partition, this can lead to a big performance gain.

For the partition predicate to work correctly, you need to know which partition your data belongs to so that you can send the request to the correct partition. One of the ways of doing it is to make use of the `PartitionAware` interface when data is inserted, thereby controlling the owning partition. Please see the [PartitionAware section](#) for more information and examples.

A concrete example may be a webshop that sells phones and accessories. To find all the accessories of a phone, a query could be executed that selects all accessories for that phone. This query is executed on all members in the cluster and therefore could generate quite a lot of load. However, if we would store the accessories in the same partition as the phone, the partition predicate could use the `partitionKey` of the phone to select the right partition and then it queries for the accessories for that phone; and this reduces the load on the system and get faster query results.

### 11.1.6. Indexing Queries

Hazelcast distributed queries will run on each member in parallel and will return only the results to the caller. Then, on the caller side, the results will be merged.

When a query runs on a member, Hazelcast will iterate through all the owned entries and find the matching ones. This can be made faster by indexing the mostly queried fields, just like you would do for your database. Indexing will add overhead for each `write` operation but queries will be a lot faster. If you query your map a lot, make sure to add indexes for the most frequently queried fields. For example, if you do an `active and age < 30` query, make sure you add an index for the `active` and `age` fields. The following example code does that by getting the map from the Hazelcast instance and adding indexes to the map with the `IMap` `addIndex` method.

```

IMap map = hazelcastInstance.getMap( "employees" );
// ordered, since we have ranged queries for this field
map.addIndex( "age", true );
// not ordered, because boolean field cannot have range
map.addIndex( "active", false );

```

## Indexing Ranged Queries

`IMap.addIndex(fieldName, ordered)` is used for adding index. For each indexed field, if you have ranged queries such as `age>30`, `age BETWEEN 40 AND 60`, then you should set the `ordered` parameter to `true`. Otherwise, set it to `false`.

## Configuring IMap Indexes

Also, you can define `IMap` indexes in configuration. An example is shown below.

```

<map name="default">
  ...
  <indexes>
    <index ordered="false">name</index>
    <index ordered="true">age</index>
  </indexes>
</map>

```

You can also define `IMap` indexes using programmatic configuration, as in the example below.

```

mapConfig.addMapIndexConfig( new MapIndexConfig( "name", false ) );
mapConfig.addMapIndexConfig( new MapIndexConfig( "age", true ) );

```

The following is the Spring declarative configuration for the same sample.

```

<hz:map name="default">
  <hz:indexes>
    <hz:index attribute="name"/>
    <hz:index attribute="age" ordered="true"/>
  </hz:indexes>
</hz:map>

```



Non-primitive types to be indexed should implement `Comparable`.



Starting with Hazelcast 3.9, if you configure the data structure to use [High-Density Memory Store](#) and indexes, the indexes are automatically stored in the High-Density Memory Store as well. This prevents from running into full GCs, when doing a lot of updates to index.

## Copying Indexes

The underlying data structures used by the indexes need to copy the query results to make sure that the results are correct. This copying process is performed either when reading the index from the data structure (on-read) or writing to it (on-write).

On-read copying means that, for each index-read operation, the result of the query is copied before it is sent to the caller. Depending on the query result's size, this type of index copying may be slower since the result is stored in a map, i.e., all entries need to have the hash calculated before being stored. Unlike the index-read operations, each index-write operation is fast, since there will be no copying taking place. So, this option can be preferred in index-write intensive cases.

On-write copying means that each index-write operation completely copies the underlying map to provide the copy-on-write semantics and this may be a slow operation depending on the index size. Unlike index-write operations, each index-read operation is fast since the operation only includes accessing the map that stores the results and returning them to the caller.

Another option is never copying the results of a query to a separate map. This means the results backed by the underlying index-map can change after the query has been executed (such as an entry might have been added or removed from an index, or it might have been remapped). This option can be preferred if you expect "mostly correct" results, i.e., if it is not a problem when some entries returned in the query result set do not match the initial query criteria. This is the fastest option since there is no copying.

You can set one these options using the system property `hazelcast.index.copy.behavior`. The following values, which are explained in the above paragraphs, can be set:

- `COPY_ON_READ` (the default value)
- `COPY_ON_WRITE`
- `NEVER`



Usage of this system property is supported for BINARY and OBJECT in-memory formats. Only in Hazelcast 3.8.7, it is also supported for NATIVE in-memory format.

## Indexing Attributes with ValueExtractor

You can also define custom attributes that may be referenced in predicates, queries and indexes. Custom attributes can be defined by implementing a `ValueExtractor`. Please see the [Custom Attributes section](#) for details.

### Using "this" as an Attribute

You can use the keyword `this` as an attribute name while adding an index or creating a predicate. A basic usage is shown below.

```
map.addIndex("this", true);  
Predicate<Integer, Integer> lessEqual = Predicates.between("this", 12, 20);
```

Another basic sample using `SqlPredicate` is shown below.

```
new SqlPredicate("this = 'jones'")
new SqlPredicate("this.age > 33")
```

The special attribute `this` acts on the value of a map entry. Typically, you do not need to specify it while accessing a property of an entry's value, since its presence is implicitly assumed if the special attribute `__key` is not specified.

### 11.1.7. Configuring Query Thread Pool

You can change the size of thread pool dedicated to query operations using the `pool-size` property. Each query consumes a single thread from a Generic Operations ThreadPool on each Hazelcast member - let's call it the query-orchestrating thread. That thread is blocked throughout the whole execution-span of a query on the member.

The query-orchestrating thread will use the threads from the query-thread pool in two cases:

- if you run a `PagingPredicate` - since each page is run as a separate task,
- if you set the system property `hazelcast.query.predicate.parallel.evaluation` to true - since the predicates are evaluated in parallel.

Please see [Filtering with Paging Predicates](#) and [System Properties](#) sections for information on paging predicates and for description of the above system property.

Below is an example of that declarative configuration.

```
<executor-service name="hz:query">
  <pool-size>100</pool-size>
</executor-service>
```

Below is the equivalent programmatic configuration.

```
Config cfg = new Config();
cfg.getExecutorConfig("hz:query").setPoolSize(100);
```

### Query Requests from Clients

When dealing with the query requests coming from the clients to your members, Hazelcast offers the following system properties to tune your thread pools:

- `hazelcast.clientengine.thread.count` which is the number of threads to process non-partition-aware client requests, like `map.size()` and executor tasks. Its default value is the number of cores multiplied by 20.
- `hazelcast.clientengine.query.thread.count` which is the number of threads to process query requests coming from the clients. Its default value is the number of cores.

If there are a lot of query request from the clients, you may want to increase the value of

`hazelcast.clientengine.query.thread.count`. In addition to this tuning, you may also consider increasing the value of `hazelcast.clientengine.thread.count` if the CPU load in your system is not high and there is plenty of free memory.

## 11.2. Querying in Collections and Arrays

Hazelcast allows querying in collections and arrays. Querying in collections and arrays is compatible with all Hazelcast serialization methods, including the Portable serialization.

Let's have a look at the following data structure expressed in pseudo-code:

```
class Motorbike {
    Wheel wheels[2];
}

class Wheel {
    String name;
}
```

In order to query a single element of a collection/array, you can execute the following query:

```
// it matches all motorbikes where the zero wheel's name is 'front-wheel'
Predicate p = Predicates.equal("wheels[0].name", "front-wheel");
Collection<Motorbike> result = map.values(p);
```

It is also possible to query a collection/array using the `any` semantic as shown below:

```
// it matches all motorbikes where any wheel's name is 'front-wheel'
Predicate p = Predicates.equal("wheels[any].name", "front-wheel");
Collection<Motorbike> result = map.values(p);
```

The exact same query may be executed using the `SQLPredicate` as shown below:

```
Predicate p = new SqlPredicate("wheels[any].name = 'front-wheel'");
Collection<Motorbike> result = map.values(p);
```

`[]` notation applies to both collections and arrays.

Hazelcast requires all elements of a collection to have the same type. Considering and expanding the above example:

- if you have a `wheels` collection attribute, all of its elements must be of the `Wheel` type, subclasses of `Wheel` are not allowed.
- Let's say you have added a `seats` collection attribute, which is a `Seat` object. Then all of its elements must of this concrete `Seat` type.



So, you may have collections of different types in your map. However, each collection's elements must be of the same concrete type within that collection attribute.

Consider custom attribute extractors if it is impossible or undesirable to reduce the variety of types to a single type. See the [Custom Attributes section](#) for information on them.

### 11.2.1. Indexing in Collections and Arrays

You can also create an index using a query in collections and arrays.

Please note that in order to leverage the index, the attribute name used in the query has to be the same as the one used in the index definition.

Let's assume you have the following index definition:

```
<indexes>
  <index ordered="false">wheels[any].name</index>
</indexes>
```

The following query will use the index:

```
Predicate p = Predicates.equal("wheels[any].name", "front-wheel");
```

The following query, however, will NOT leverage the index, since it does not use exactly the same attribute name that was used in the index:

```
Predicates.equal("wheels[0].name", "front-wheel")
```

In order to use the index in the case mentioned above, you have to create another index, as shown below:

```
<indexes>
  <index ordered="false">wheels[0].name</index>
</indexes>
```

## 11.2.2. Corner cases

Handling of corner cases may be a bit different than in a programming language like `Java`.

Let's have a look at the following examples in order to understand the differences. To make the analysis simpler, let's assume that there is only one `Motorbike` object stored in a Hazelcast Map.

Id	Query	Data State	Extraction Result	Match
1	<code>Predicates.equal("wheels[7].name", "front-wheel")</code>	<code>wheels.size() == 1</code>	<code>null</code>	No
2	<code>Predicates.equal("wheels[7].name", null)</code>	<code>wheels.size() == 1</code>	<code>null</code>	Yes
3	<code>Predicates.equal("wheels[0].name", "front-wheel")</code>	<code>wheels[0].name == null</code>	<code>null</code>	No
4	<code>Predicates.equal("wheels[0].name", null)</code>	<code>wheels[0].name == null</code>	<code>null</code>	Yes
5	<code>Predicates.equal("wheels[0].name", "front-wheel")</code>	<code>wheels[0] == null</code>	<code>null</code>	No
6	<code>Predicates.equal("wheels[0].name", null)</code>	<code>wheels[0] == null</code>	<code>null</code>	Yes
7	<code>Predicates.equal("wheels[0].name", "front-wheel")</code>	<code>wheels == null</code>	<code>null</code>	No
8	<code>Predicates.equal("wheels[0].name", null)</code>	<code>wheels == null</code>	<code>null</code>	Yes

As you can see, **no** `NullPointerException`'s or `IndexOutOfBoundsException`'s are thrown in the extraction process, even though parts of the expression are `null`.

Looking at examples 4, 6 and 8, we can also easily notice that it is impossible to distinguish which part of the expression was null. If we execute the following query `wheels[1].name = null`, it may be evaluated to true because:

- `wheels` collection/array is null.
- `index == 1` is out of bound.
- `name` attribute of the `wheels[1]` object is `null`.

In order to make the query unambiguous, extra conditions would have to be added, e.g., `wheels != null AND wheels[1].name = null`.

## 11.3. Custom Attributes

It is possible to define a custom attribute that may be referenced in predicates, queries and indexes.

A custom attribute is a "synthetic" attribute that does not exist as a `field` or a `getter` in the object

that it is extracted from. Thus, it is necessary to define the policy on how the attribute is supposed to be extracted. Currently the only way to extract a custom attribute is to implement a `com.hazelcast.query.extractor.ValueExtractor` that encompasses the extraction logic.

Custom Attributes are compatible with all Hazelcast serialization methods, including the Portable serialization.

### 11.3.1. Implementing a ValueExtractor

In order to implement a `ValueExtractor`, extend the abstract `com.hazelcast.query.extractor.ValueExtractor` class and implement the `extract()` method. This method does not return any values since the extracted value is collected by the `ValueCollector`. In order to return multiple results from a single extraction, invoke the `ValueCollector.collect()` method multiple times, so that the collector collects all results.

Please refer to the `ValueExtractor` and `ValueCollector` Javadocs.

#### ValueExtractor with Portable Serialization

Portable serialization is a special kind of serialization where there is no need to have the class of the serialized object on the classpath in order to read its attributes. That is the reason why the target object passed to the `ValueExtractor.extract()` method will not be of the exact type that has been stored. Instead, an instance of a `com.hazelcast.query.extractor.ValueReader` will be passed. `ValueReader` enables reading the attributes of a Portable object in a generic and type-agnostic way. It contains two methods:

- `read(String path, ValueCollector<T> collector)` - enables passing all results directly to the `ValueCollector`.
- `read(String path, ValueCallback<T> callback)` - enables filtering, transforming and grouping the result of the read operation and manually passing it to the `ValueCollector`.

Please refer to the `ValueReader` Javadoc.

#### Returning Multiple Values from a Single Extraction

It sounds counter-intuitive, but a single extraction may return multiple values when arrays or collections are involved. Let's have a look at the following data structure in pseudo-code:

```
class Motorbike {
    Wheel wheel[2];
}

class Wheel {
    String name;
}
```

Let's assume that we want to extract the names of all wheels from a single motorbike object. Each motorbike has two wheels so there are two names for each bike. In order to return both values from the extraction operation, collect them separately using the `ValueCollector`. Collecting multiple



values in this way allows you to operate on these multiple values as if they were single values during the evaluation of the predicates.

Let's assume that we registered a custom extractor with the name `wheelName` and executed the following query: `wheelName = front-wheel`.

The extraction may return up to two wheel names for each `Motorbike` since each `Motorbike` has up to two wheels. In such a case, it is enough if a single value evaluates the predicate's condition to true to return a match, so it will return a `Motorbike` if "any" of the wheels matches the expression.

### 11.3.2. Extraction Arguments

A `ValueExtractor` may use a custom argument if it is specified in the query. The custom argument may be passed within the square brackets located after the name of the custom attribute, e.g., `customAttribute[argument]`.

Let's have a look at the following query: `currency[incoming] == EUR` The `currency` is a custom attribute that uses a `com.test.CurrencyExtractor` for extraction.

The string `incoming` is an argument that will be passed to the `ArgumentParser` during the extraction. The parser will parse the string according to the parser's custom logic and it will return a parsed object. The parsed object may be a single object, array, collection, or any arbitrary object. It is up to the `ValueExtractor`'s implementor to understand the semantics of the parsed argument object.

For now it is **not** possible to register a custom `ArgumentParser`, thus a default parser is used. It follows a `pass-through` semantic, which means that the string located in the square brackets is passed "as is" to the `ValueExtractor.extract()` method.

Please note that using square brackets within the argument string is not allowed.

### 11.3.3. Configuring a Custom Attribute Programmatically

The following snippet demonstrates how to define a custom attribute using a `ValueExtractor`.

```
MapAttributeConfig attributeConfig = new MapAttributeConfig();
attributeConfig.setName("currency");
attributeConfig.setExtractor("com.bank.CurrencyExtractor");

MapConfig mapConfig = new MapConfig();
mapConfig.addMapAttributeConfig(attributeConfig);
```

`currency` is the name of the custom attribute that will be extracted using the `CurrencyExtractor` class.

Keep in mind that an extractor may not be added after the map has been instantiated. All extractors have to be defined upfront in the map's initial configuration.

### 11.3.4. Configuring a Custom Attribute Declaratively

The following snippet demonstrates how to define a custom attribute in the Hazelcast XML

Configuration.

```
<map name="trades">
  <attributes>
    <attribute extractor="com.bank.CurrencyExtractor">currency</attribute>
  </attributes>
</map>
```

Analogous to the example above, `currency` is the name of the custom attribute that will be extracted using the `CurrencyExtractor` class.

Please note that an attribute name may begin with an ASCII letter [A-Za-z] or digit [0-9] and may contain ASCII letters [A-Za-z], digits [0-9] or underscores later on.

### 11.3.5. Indexing Custom Attributes

You can create an index using a custom attribute.

The name of the attribute used in the index definition has to match the one used in the attributes configuration.

Defining indexes with extraction arguments is allowed, as shown in the example below:

```
<indexes>
  <!-- custom attribute without an extraction argument -->
  <index ordered="true">currency</index>

  <!-- custom attribute using an extraction argument -->
  <index ordered="true">currency[incoming]</index>
</indexes>
```

## 11.4. MapReduce



MapReduce is deprecated since Hazelcast 3.8. You can use [Fast-Aggregations](#) and [Hazelcast Jet](#) for map aggregations and general data processing, respectively. Please see the [MapReduce Deprecation section](#) for more details.

You have likely heard about MapReduce ever since Google released its [research white paper](#) on this concept. With Hadoop as the most common and well known implementation, MapReduce gained a broad audience and made it into all kinds of business applications dominated by data warehouses.

MapReduce is a software framework for processing large amounts of data in a distributed way. Therefore, the processing is normally spread over several machines. The basic idea behind MapReduce is that source data is mapped into a collection of key-value pairs and reducing those pairs, grouped by key, in a second step towards the final result.

The main idea can be summarized with the following steps.

1. Read the source data.
2. Map the data to one or multiple key-value pairs.
3. Reduce all pairs with the same key.

## Use Cases

The best known examples for MapReduce algorithms are text processing tools, such as counting the word frequency in large texts or websites. Apart from that, there are more interesting examples of use cases listed below.

- Log Analysis
- Data Querying
- Aggregation and summing
- Distributed Sort
- ETL (Extract Transform Load)
- Credit and Risk management
- Fraud detection
- and more.

### 11.4.1. Understanding MapReduce

This section will give deeper insight into the MapReduce pattern and will help you understand the semantics behind the different MapReduce phases and how they are implemented in Hazelcast.

In addition to this, the following sections compare Hadoop and Hazelcast MapReduce implementations to help adopters with Hadoop backgrounds quickly get familiar with Hazelcast MapReduce.

#### MapReduce Workflow Example

The flowchart below demonstrates the basic workflow of the word count example (distributed occurrences analysis) mentioned in the [MapReduce section](#) introduction. From left to right, it iterates over all the entries of a data structure (in this case an IMap). In the mapping phase, it splits the sentence into single words and emits a key-value pair per word: the word is the key, 1 is the value. In the next phase, values are collected (grouped) and transported to their corresponding reducers, where they are eventually reduced to a single key-value pair, the value being the number of occurrences of the word. At the last step, the different reducer results are grouped up to the final result and returned to the requester.

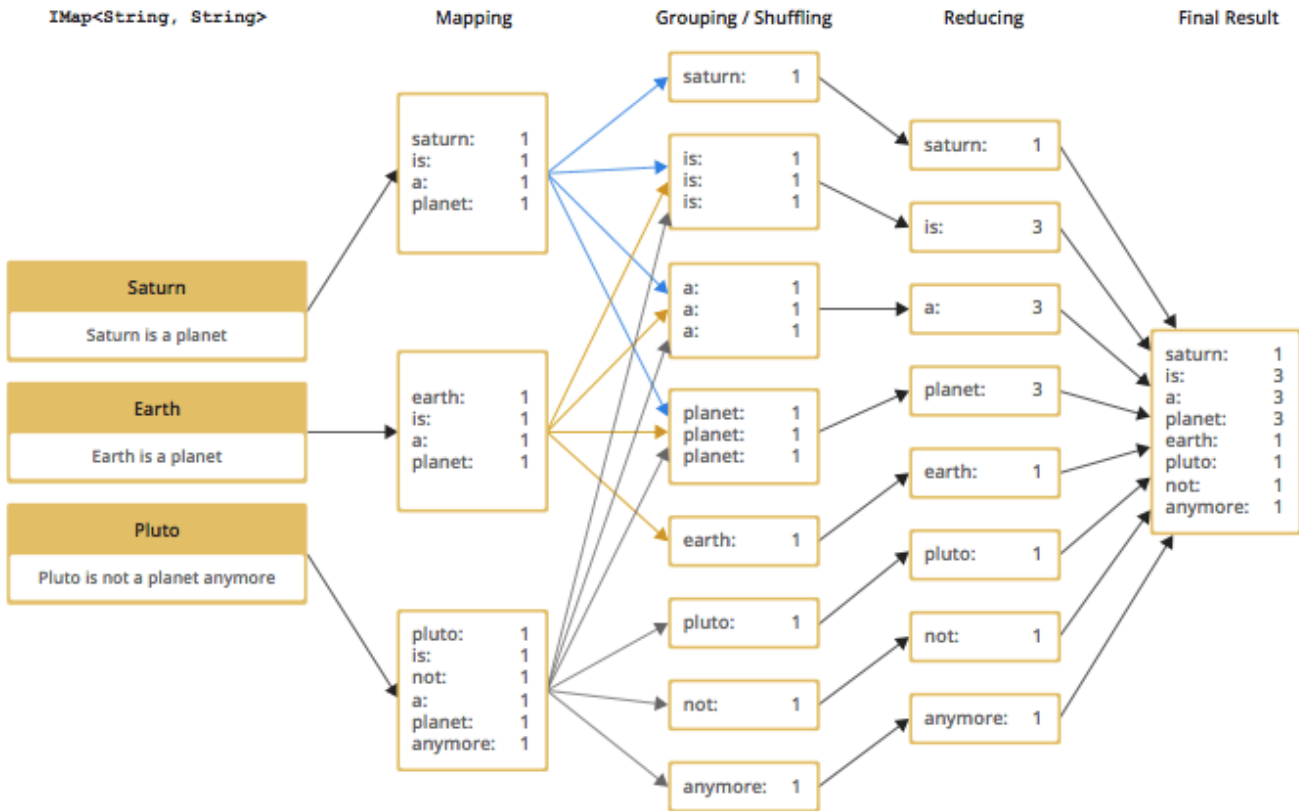

In pseudo code, the corresponding map and reduce function would look like the following. A Hazelcast code example will be shown in the next section.

```
map( key:String, document:String ):Void ->
  for each w:word in document:
    emit( w, 1 )

reduce( word:String, counts:List[Int] ):Int ->
  return sum( counts )
```

## MapReduce Phases

As seen in the workflow example, a MapReduce process consists of multiple phases. The original MapReduce pattern describes two phases (map, reduce) and one optional phase (combine). In Hazelcast, these phases either only exist virtually to explain the data flow, or are executed in parallel during the real operation while the general idea is still persisting.

$(K \times V)^* \rightarrow (L \times W)^*$

$[(k^*1^*, v^*1^*), \dots, (k^*n^*, v^*n^*)] \rightarrow [(l^*1^*, w^*1^*), \dots, (l^*m^*, w^*m^*)]$

## Mapping Phase

The mapping phase iterates all key-value pairs of any kind of legal input source. The mapper then analyzes the input pairs and emits zero or more new key-value pairs.

$K \times V \rightarrow (L \times W)^*$

$(k, v) \rightarrow [(l^{*1*}, w^{*1*}), \dots, (l^{*n*}, w^{*n*})]$

## Combine Phase

In the combine phase, multiple key-value pairs with the same key are collected and combined to an intermediate result before being sent to the reducers. **Combine phase is also optional in Hazelcast, but is highly recommended to lower the traffic.**

In terms of the word count example, this can be explained using the sentences "Saturn is a planet but the Earth is a planet, too". As shown above, we would send two key-value pairs (planet, 1). The registered combiner now collects those two pairs and combines them into an intermediate result of (planet, 2). Instead of two key-value pairs sent through the wire, there is now only one for the key "planet".

The pseudo code for a combiner is similar to the reducer.

```
combine( word:String, counts:List[Int] ):Void ->
  emit( word, sum( counts ) )
```

## Grouping / Shuffling Phase

The grouping or shuffling phase only exists virtually in Hazelcast since it is not a real phase; emitted key-value pairs with the same key are always transferred to the same reducer in the same job. They are grouped together, which is equivalent to the shuffling phase.

## Reducing Phase

In the reducing phase, the collected intermediate key-value pairs are reduced by their keys to build the final by-key result. This value can be a sum of all the emitted values of the same key, an average value, or something completely different, depending on the use case.

Here is a reduced representation of this phase.

$L \times W^* \rightarrow X^*$

$(l, [w^{*1*}, \dots, w^{*n*}]) \rightarrow [x^{*1*}, \dots, x^{*n*}]$

## Producing the Final Result

This is not a real MapReduce phase, but it is the final step in Hazelcast after all reducers are notified that reducing has finished. The original job initiator then requests all reduced results and builds the final result.

## Additional MapReduce Resources

The Internet is full of useful resources for finding deeper information on MapReduce. Below is a short collection of more introduction material. In addition, there are books written about all kinds of MapReduce patterns and how to write a MapReduce function for your use case. To name them all is out of the scope of this documentation, but here are some resources:

- <http://research.google.com/archive/mapreduce.html>
- <http://en.wikipedia.org/wiki/MapReduce>
- [http://hci.stanford.edu/courses/cs448g/a2/files/map\\_reduce\\_tutorial.pdf](http://hci.stanford.edu/courses/cs448g/a2/files/map_reduce_tutorial.pdf)
- <http://ksat.me/map-reduce-a-really-simple-introduction-kloudo/>
- <http://www.slideshare.net/franibandov/an-introduction-to-mapreduce-6789635>

### 11.4.2. Using the MapReduce API

This section explains the basics of the Hazelcast MapReduce framework. While walking through the different API classes, we will build the [word count example that was discussed earlier](#) and create it step by step.

The Hazelcast API for MapReduce operations consists of a fluent DSL-like configuration syntax to build and submit jobs. `JobTracker` is the basic entry point to all MapReduce operations and is retrieved from `com.hazelcast.core.HazelcastInstance` by calling `getJobTracker` and supplying the name of the required `JobTracker` configuration. The configuration for `JobTracker`'s will be discussed later; for now we focus on the API itself. In addition, the complete submission part of the API is built to support a fully reactive way of programming.

To give an easy introduction to people used to Hadoop, we created the class names to be as familiar as possible to their counterparts on Hadoop. That means while most users will recognize a lot of similar sounding classes, the way to configure the jobs is more fluent due to the DSL-like styled API.

While building the example, we will go through as many options as possible, e.g., we will create a specialized `JobTracker` configuration (at the end). Special `JobTracker` configuration is not required, because for all other Hazelcast features you can use "default" as the configuration name. However, special configurations offer better options to predict behavior of the framework execution.

The full example is available [here](#) as a ready to run Maven project.

#### Retrieving a JobTracker Instance

`JobTracker` creates Job instances, whereas every instance of `com.hazelcast.mapreduce.Job` defines a single MapReduce configuration. The same Job can be submitted multiple times regardless of whether it is executed in parallel or after the previous execution is finished.



After retrieving the `JobTracker`, be aware that it should only be used with data structures derived from the same `HazelcastInstance`. Otherwise, you can get unexpected behavior.

To retrieve a `JobTracker` from Hazelcast, we will start by using the "default" configuration for convenience reasons to show the basic way.

```
JobTracker jobTracker = hazelcastInstance.getJobTracker( "default" );
```

`JobTracker` is retrieved using the same kind of entry point as most other Hazelcast features. After building the cluster connection, you use the created `HazelcastInstance` to request the configured (or

default) `JobTracker` from Hazelcast.

The next step will be to create a new `Job` and configure it to execute our first MapReduce request against cluster data.

## Creating a Job

As mentioned in the previous section, you create a `Job` using the retrieved `JobTracker` instance. A `Job` defines exactly one configuration of a MapReduce task. Mapper, combiner and reducers will be defined per job. However, since the `Job` instance is only a configuration, it can be submitted multiple times, regardless of whether executions happen in parallel or one after the other.

A submitted job is always identified using a unique combination of the `JobTracker`'s name and a `jobId` generated on submit-time. The way to retrieve the `jobId` will be shown in one of the later sections.

To create a `Job`, a second class `com.hazelcast.mapreduce.KeyValueSource` is necessary. We will have a deeper look at the `KeyValueSource` class in the next section. `KeyValueSource` is used to wrap any kind of data or data structure into a well defined set of key-value pairs.

The example code below is a direct follow up to the example in [Retrieving a JobTracker Instance](#). It reuses the already created `HazelcastInstance` and `JobTracker` instances.

The example starts by retrieving an instance of our data map and then it creates the `Job` instance. Implementations used to configure the `Job` will be discussed while walking further through the API documentation.



Since the `Job` class is highly dependent upon generics to support type safety, the generics change over time and may not be assignment compatible to old variable types. To make use of the full potential of the fluent API, we recommend you use fluent method chaining as shown in this example to prevent the need for too many variables.

```
IMap<String, String> map = hazelcastInstance.getMap( "articles" );
KeyValueSource<String, String> source = KeyValueSource.fromMap( map );
Job<String, String> job = jobTracker.newJob( source );

ICompletableFuture<Map<String, Long>> future = job
    .mapper( new TokenizerMapper() )
    .combiner( new WordCountCombinerFactory() )
    .reducer( new WordCountReducerFactory() )
    .submit();

// Attach a callback listener
future.andThen( buildCallback() );

// Wait and retrieve the result
Map<String, Long> result = future.get();
```

As seen above, we create the Job instance and define a mapper, combiner and reducer. Then we submit the request to the cluster. The `submit` method returns an `CompletableFuture` that can be used to attach our callbacks or to wait for the result to be processed in a blocking fashion.

There are more options available for job configurations, such as defining a general chunk size or on what keys the operation will operate. For more information, please refer to the [Hazelcast source code for Job.java](#).

## Creating Key-Value Input Sources with `KeyValueSource`

`KeyValueSource` can either wrap Hazelcast data structures (like `IMap`, `MultiMap`, `IList`, `ISet`) into key-value pair input sources, or build your own custom key-value input source. The latter option makes it possible to feed Hazelcast MapReduce with all kinds of data, such as just-in-time downloaded web page contents or data files. People familiar with Hadoop will recognize similarities with the `Input` class.

You can imagine a `KeyValueSource` as a bigger `java.util.Iterator` implementation. Whereas most methods must be implemented, implementing the `getAllKeys` method is optional. If implementation is able to gather all keys upfront, it should be implemented and `isAllKeysSupported` must return `true`. That way, Job configured `KeyPredicates` are able to evaluate keys upfront before sending them to the cluster. Otherwise they are serialized and transferred as well, to be evaluated at execution time.

As shown in the example above, the abstract `KeyValueSource` class provides a number of static methods to easily wrap Hazelcast data structures into `KeyValueSource` implementations already provided by Hazelcast. The data structures' generics are inherited by the resulting `KeyValueSource` instance. For data structures like `IList` or `ISet`, the key type is always `String`. While mapping, the key is the data structure's name, whereas the value type and value itself are inherited from the `IList` or `ISet` itself.

```
// KeyValueSource from com.hazelcast.core.IMap
IMap<String, String> map = hazelcastInstance.getMap( "my-map" );
KeyValueSource<String, String> source = KeyValueSource.fromMap( map );
```

```
// KeyValueSource from com.hazelcast.core.MultiMap
MultiMap<String, String> multiMap = hazelcastInstance.getMultiMap( "my-multimap" );
KeyValueSource<String, String> source = KeyValueSource.fromMultiMap( multiMap );
```

```
// KeyValueSource from com.hazelcast.core.IList
IList<String> list = hazelcastInstance.getList( "my-list" );
KeyValueSource<String, String> source = KeyValueSource.fromList( list );
```

```
// KeyValueSource from com.hazelcast.core.ISet
ISet<String> set = hazelcastInstance.getSet( "my-set" );
KeyValueSource<String, String> source = KeyValueSource.fromSet( set );
```



## PartitionIdAware

The `com.hazelcast.mapreduce.PartitionIdAware` interface can be implemented by the `KeyValueSource` implementation if the underlying data set is aware of the Hazelcast partitioning schema (as it is for all internal data structures). If this interface is implemented, the same `KeyValueSource` instance is reused multiple times for all partitions on the cluster member. As a consequence, the `close` and `open` methods are also executed multiple times but once per `partitionId`.

## Implementing Mapping Logic with Mapper

Using the `Mapper` interface, you will implement the mapping logic. Mappers can transform, split, calculate and aggregate data from data sources. In Hazelcast you can also integrate data from more than the `KeyValueSource` data source by implementing `com.hazelcast.core.HazelcastInstanceAware` and requesting additional maps, multimaps, list and/or sets.

The mappers `map` function is called once per available entry in the data structure. If you work on distributed data structures that operate in a partition-based fashion, multiple mappers work in parallel on the different cluster members on the members' assigned partitions. Mappers then prepare and maybe transform the input key-value pair and emit zero or more key-value pairs for the reducing phase.

For our word count example, we retrieve an input document (a text document) and we transform it by splitting the text into the available words. After that, as discussed in the [pseudo code](#), we emit every single word with a key-value pair with the word as the key and 1 as the value.

A common implementation of that `Mapper` might look like the following example:

```
public class TokenizerMapper implements Mapper<String, String, String, Long> {
    private static final Long ONE = Long.valueOf( 1L );

    @Override
    public void map(String key, String document, Context<String, Long> context) {
        StringTokenizer tokenizer = new StringTokenizer( document.toLowerCase() );
        while ( tokenizer.hasMoreTokens() ) {
            context.emit( tokenizer.nextToken(), ONE );
        }
    }
}
```

This code splits the mapped texts into their tokens, iterates over the tokenizer as long as there are more tokens and emits a pair per word. Note that we're not yet collecting multiple occurrences of the same word, we just fire every word on its own.

## LifecycleMapper / LifecycleMapperAdapter

The `LifecycleMapper` interface or its adapter class `LifecycleMapperAdapter` can be used to make the `Mapper` implementation lifecycle aware. That means it will be notified when mapping of a partition or set of data begins and when the last entry was mapped.

Only special algorithms might need those additional lifecycle events to prepare, clean up, or emit additional values.

### **Minimizing Cluster Traffic with Combiner**

As stated in the introduction, a Combiner is used to minimize traffic between the different cluster members when transmitting mapped values from mappers to the reducers. It does this by aggregating multiple values for the same emitted key. This is a fully optional operation, but using it is highly recommended.

Combiners can be seen as an intermediate reducer. The calculated value is always assigned back to the key for which the combiner initially was created. Since combiners are created per emitted key, the Combiner implementation itself is not defined in the jobs configuration; instead, a `CombinerFactory` that is able to create the expected Combiner instance is created.

Because Hazelcast MapReduce is executing the mapping and reducing phases in parallel, the Combiner implementation must be able to deal with chunked data. Therefore, you must reset its internal state whenever you call `finalizeChunk`. Calling the `finalizeChunk` method creates a chunk of intermediate data to be grouped (shuffled) and sent to the reducers.

Combiners can override `beginCombine` and `finalizeCombine` to perform preparation or cleanup work.

For our word count example, we are going to have a simple `CombinerFactory` and Combiner implementation similar to the following example.

```

public class WordCountCombinerFactory
    implements CombinerFactory<String, Long, Long> {

    @Override
    public Combiner<Long, Long> newCombiner( String key ) {
        return new WordCountCombiner();
    }

    private class WordCountCombiner extends Combiner<Long, Long> {
        private long sum = 0;

        @Override
        public void combine( Long value ) {
            sum++;
        }

        @Override
        public Long finalizeChunk() {
            return sum;
        }

        @Override
        public void reset() {
            sum = 0;
        }
    }
}

```

The Combiner must be able to return its current value as a chunk and reset the internal state by setting `sum` back to 0. Since combiners are always called from a single thread, no synchronization or volatility of the variables is necessary.

### Doing Algorithm Work with Reducer

Reducers do the last bit of algorithm work. This can be aggregating values, calculating averages, or any other work that is expected from the algorithm.

Since values arrive in chunks, the `reduce` method is called multiple times for every emitted value of the creation key. This also can happen multiple times per chunk if no Combiner implementation was configured for a job configuration.

Unlike combiners, a reducer's `finalizeReduce` method is only called once per reducer (which means once per key). Therefore, a reducer does not need to reset its internal state at any time.

Reducers can override `beginReduce` to perform preparation work.

For our word count example, the implementation will look similar to the following code example.

```

public class WordCountReducerFactory implements ReducerFactory<String, Long, Long> {

    @Override
    public Reducer<Long, Long> newReducer( String key ) {
        return new WordCountReducer();
    }

    private class WordCountReducer extends Reducer<Long, Long> {
        private volatile long sum = 0;

        @Override
        public void reduce( Long value ) {
            sum += value.longValue();
        }

        @Override
        public Long finalizeReduce() {
            return sum;
        }
    }
}

```

### Reducers Switching Threads

Unlike combiners, reducers tend to switch threads if running out of data to prevent blocking threads from the `JobTracker` configuration. They are rescheduled at a later point when new data to be processed arrives, but are unlikely to be executed on the same thread as before. As of Hazelcast version 3.3.3 the guarantee for memory visibility on the new thread is ensured by the framework. This means the previous requirement for making fields volatile is dropped.

### Modifying the Result with Collator

A Collator is an optional operation that is executed on the job emitting member and is able to modify the finally reduced result before returned to the user's codebase. Only special use cases are likely to use collators.

For an imaginary use case, we might want to know how many words were all over in the documents we analyzed. For this case, a Collator implementation can be given to the `submit` method of the Job instance.

A collator would look like the following snippet:

```

public class WordCountCollator implements Collator<Map.Entry<String, Long>, Long> {

    @Override
    public Long collate( Iterable<Map.Entry<String, Long>> values ) {
        long sum = 0;

        for ( Map.Entry<String, Long> entry : values ) {
            sum += entry.getValue().longValue();
        }
        return sum;
    }
}

```

The definition of the input type is a bit strange, but because Combiner and Reducer implementations are optional, the input type heavily depends on the state of the data. As stated above, collators are non-typical use cases and the generics of the framework always help in finding the correct signature.

### Preselecting Keys with KeyPredicate

You can use `KeyPredicate` to pre-select whether or not a key should be selected for mapping in the mapping phase. If the `KeyValueSource` implementation is able to know all keys prior to execution, the keys are filtered before the operations are divided among the different cluster members.

A `KeyPredicate` can also be used to select only a special range of data, e.g., a time frame, or in similar use cases.

A basic `KeyPredicate` implementation that only maps keys containing the word "hazelcast" might look like the following code example:

```

public class WordCountKeyPredicate implements KeyPredicate<String> {

    @Override
    public boolean evaluate( String s ) {
        return s != null && s.toLowerCase().contains( "hazelcast" );
    }
}

```

### Job Monitoring with TrackableJob

You can retrieve a `TrackableJob` instance after submitting a job. It is requested from the `JobTracker` using the unique jobId (per `JobTracker`). You can use it get runtime statistics of the job. The information available is limited to the number of processed (mapped) records and the processing state of the different partitions or members (if `KeyValueSource` is not `PartitionIdAware`).

To retrieve the jobId after submission of the job, use `com.hazelcast.mapreduce.JobCompletableFuture` instead of the `com.hazelcast.core.ICompletableFuture` as the variable type for the returned future.

The example code below gives a quick introduction on how to retrieve the instance and the runtime data. For more information, please have a look at the Javadoc corresponding your running Hazelcast version.

The example performs the following steps to get the job instance.

- It gets the map with the hazelcastInstance `getMap` method.
- From the map, it gets the source with the `KeyValueSource.fromMap` method.
- From the source, it gets a job with the `JobTracker.newJob` method.

```
IMap<String, String> map = hazelcastInstance.getMap( "articles" );
KeyValueSource<String, String> source = KeyValueSource.fromMap( map );
Job<String, String> job = jobTracker.newJob( source );

JobCompletableFuture<Map<String, Long>> future = job
    .mapper( new TokenizerMapper() )
    .combiner( new WordCountCombinerFactory() )
    .reducer( new WordCountReducerFactory() )
    .submit();

String jobId = future.getJobId();
TrackableJob trackableJob = jobTracker.getTrackableJob(jobId);

JobProcessInformation stats = trackableJob.getJobProcessInformation();
int processedRecords = stats.getProcessedRecords();
log( "ProcessedRecords: " + processedRecords );

JobPartitionState[] partitionStates = stats.getPartitionStates();
for ( JobPartitionState partitionState : partitionStates ) {
    log( "PartitionOwner: " + partitionState.getOwner()
        + ", Processing state: " + partitionState.getState().name() );
}
```



Caching of the `JobProcessInformation` does not work on Java native clients since current values are retrieved while retrieving the instance to minimize traffic between executing member and client.

## Configuring JobTracker

You configure `JobTracker` configuration to set up behavior of the Hazelcast MapReduce framework.

Every `JobTracker` is capable of running multiple MapReduce jobs at once; one configuration is meant as a shared resource for all jobs created by the same `JobTracker`. The configuration gives full control over the expected load behavior and thread counts to be used.

The following snippet shows a typical `JobTracker` configuration. The configuration properties are discussed below the example.

```

<jobtracker name="default">
  <max-thread-size>0</max-thread-size>
  <!-- Queue size 0 means number of partitions * 2 -->
  <queue-size>0</queue-size>
  <retry-count>0</retry-count>
  <chunk-size>1000</chunk-size>
  <communicate-stats>true</communicate-stats>
  <topology-changed-strategy>CANCEL_RUNNING_OPERATION</topology-changed-strategy>
</jobtracker>

```

- **max-thread-size**: Maximum thread pool size of the JobTracker.
- **queue-size**: Maximum number of tasks that are able to wait to be processed. A value of 0 means an unbounded queue. Very low numbers can prevent successful execution since the job might not be correctly scheduled or intermediate chunks might be lost.
- **retry-count**: Currently not used. Reserved for later use where the framework will automatically try to restart/retry operations from an available save point.
- **chunk-size**: Number of emitted values before a chunk is sent to the reducers. If your emitted values are big or you want to better balance your work, you might want to change this to a lower or higher value. A value of 0 means immediate transmission, but remember that low values mean higher traffic costs. A very high value might cause an `OutOfMemoryError` to occur if the emitted values do not fit into heap memory before being sent to the reducers. To prevent this, you might want to use a combiner to pre-reduce values on mapping members.
- **communicate-stats**: Specifies whether the statistics (for example, statistics about processed entries) are transmitted to the job emitter. This can show progress to a user inside of an UI system, but it produces additional traffic. If not needed, you might want to deactivate this.
- **topology-changed-strategy**: Specifies how the MapReduce framework reacts on topology changes while executing a job. Currently, only `CANCEL_RUNNING_OPERATION` is fully supported, which throws an exception to the job emitter (will throw a `com.hazelcast.mapreduce.TopologyChangedException`).

### 11.4.3. Hazelcast MapReduce Architecture

This section explains some of the internals of the MapReduce framework. This is more advanced information. If you're not interested in how it works internally, you might want to skip this section.

#### Member Interoperation Example

To understand the following technical internals, we first have a short look at what happens in terms of an example workflow.

As a simple example, think of an `IMap<String, Integer>` and emitted keys having the same types. Imagine you have a cluster with three members and you initiate the MapReduce job on the first member. After you requested the JobTracker from your running/connected Hazelcast, we submit the task and retrieve the `CompletableFuture`, which gives us a chance to wait for the result to be calculated or to add a callback (and being more reactive).

The example expects that the chunk size is 0 or 1, so an emitted value is directly sent to the reducers. Internally, the job is prepared, started and executed on all members as shown below. The first member acts as the job owner (job emitter).

```
Member1 starts MapReduce job
Member1 emits key=Foo, value=1
Member1 does PartitionService::getKeyOwner(Foo) => results in Member3

Member2 emits key=Foo, value=14
Member2 asks jobOwner (Member1) for keyOwner of Foo => results in Member3

Member1 sends chunk for key=Foo to Member3

Member3 receives chunk for key=Foo and looks if there is already a Reducer,
    if not creates one for key=Foo
Member3 processes chunk for key=Foo

Member2 sends chunk for key=Foo to Member3

Member3 receives chunk for key=Foo and looks if there is already a Reducer and uses
    the previous one
Member3 processes chunk for key=Foo

Member1 send LastChunk information to Member3 because processing local values finished

Member2 emits key=Foo, value=27
Member2 has cached keyOwner of Foo => results in Member3
Member2 sends chunk for key=Foo to Member3

Member3 receives chunk for key=Foo and looks if there is already a Reducer and uses
    the previous one
Member3 processes chunk for key=Foo

Member2 send LastChunk information to Member3 because processing local values finished

Member3 finishes reducing for key=Foo

Member1 registers its local partitions are processed
Member2 registers its local partitions are processed

Member1 sees all partitions processed and requests reducing from all members

Member1 merges all reduced results together in a final structure and returns it
```

The flow is quite complex but extremely powerful since everything is executed in parallel. Reducers do not wait until all values are emitted, but they immediately begin to reduce (when the first chunk for an emitted key arrives).



## Internal MapReduce Packages

Beginning with the package level, there is one basic package: `com.hazelcast.mapreduce`. This includes the external API and the **impl** package, which itself contains the internal implementation.

- The **impl** package contains all the default `KeyValueSource` implementations and abstract base and support classes for the exposed API.
- The **client** package contains all classes that are needed on the client and member sides when a client offers a MapReduce job.
- The **notification** package contains all "notification" or event classes that notify other members about progress on operations.
- The **operation** package contains all operations that are used by the workers or job owner to coordinate work and sync partition or reducer processing.
- The **task** package contains all classes that execute the actual MapReduce operation. It features the supervisor, mapping phase implementation and mapping/reducing tasks.

## MapReduce Job Walk-Through

Now to the technical walk-through: A MapReduce Job is always retrieved from a named `JobTracker`, which is implemented in `NodeJobTracker` (extends `AbstractJobTracker`) and is configured using the configuration DSL. All of the internal implementation is completely `ICompletableFuture`-driven and mostly non-blocking in design.

On submit, the Job creates a unique UUID which afterwards acts as a `jobId` and is combined with the `JobTracker`'s name to be uniquely identifiable inside the cluster. Then, the preparation is sent around the cluster and every member prepares its execution by creating a `JobSupervisor`, `MapCombineTask` and `ReducerTask`. The job-emitting `JobSupervisor` gains special capabilities to synchronize and control `JobSupervisors` on other members for the same job.

If preparation is finished on all members, the job itself is started by executing a `StartProcessingJobOperation` on every member. This initiates a `MappingPhase` implementation (defaults to `KeyValueSourceMappingPhase`) and starts the actual mapping on the members.

The mapping process is currently a single threaded operation per member, but will be extended to run in parallel on multiple partitions (configurable per Job) in future versions. The Mapper is now called on every available value on the partition and eventually emits values. For every emitted value, either a configured `CombinerFactory` is called to create a `Combiner` or a cached one is used (or the default `CollectingCombinerFactory` is used to create `Combiners`). When the chunk limit is reached on a member, a `IntermediateChunkNotification` is prepared by collecting emitted keys to their corresponding members. This is either done by asking the job owner to assign members or by an already cached assignment. In later versions, a `PartitionStrategy` might also be configurable.

The `IntermediateChunkNotification` is then sent to the reducers (containing only values for this member) and is offered to the `ReducerTask`. On every offer, the `ReducerTask` checks if it is already running and if not, it submits itself to the configured `ExecutorService` (from the `JobTracker` configuration).

If reducer queue runs out of work, the `ReducerTask` is removed from the `ExecutorService` to not

block threads but eventually will be resubmitted on next chunk of work.

On every phase, the partition state is changed to keep track of the currently running operations. A `JobPartitionState` can be in one of the following states with self-explanatory titles: `[WAITING, MAPPING, REDUCING, PROCESSED, CANCELLED]`. If you have a deeper interest of these states, look at the Javadoc.

- Member asks for new partition to process: `WAITING` ⇒ `MAPPING`
- Member emits first chunk to a reducer: `MAPPING` ⇒ `REDUCING`
- All members signal that they finished mapping phase and reducing is finished, too: `REDUCING` ⇒ `PROCESSED`

Eventually, all `JobPartitionStates` reach the state of `PROCESSED`. Then, the job emitter's `JobSupervisor` asks all members for their reduced results and executes a potentially offered `Collator`. With this `Collator`, the overall result is calculated before it removes itself from the `JobTracker`, doing some final cleanup and returning the result to the requester (using the internal `TrackableJobFuture`).

If a job is cancelled while execution, all partitions are immediately set to the `CANCELLED` state and a `CancelJobSupervisorOperation` is executed on all members to kill the running processes.

While the operation is running in addition to the default operations, some more operations like `ProcessStatsUpdateOperation` (updates processed records statistics) or `NotifyRemoteExceptionOperation` (notifies the members that the sending member encountered an unrecoverable situation and the Job needs to be cancelled, e.g., `NullPointerException` inside of a `Mapper`, are executed against the job owner to keep track of the process.

#### 11.4.4. MapReduce Deprecation

This section informs Hazelcast users about the MapReduce deprecation, it's motivation and replacements.

##### Motivation

We've decided to deprecate the MapReduce framework in Hazelcast IMDG 3.8. The MapReduce framework provided the distributed computing model and it was used to back the old Aggregations system. Unfortunately the implementation didn't live up to the expectations and adoption wasn't high, so it never got out of Beta status. Apart from that the current shift in development away from M/R-like processing to a more near-realtime, streaming approach left us with the decision to deprecate and finally remove the MapReduce framework from Hazelcast IMDG. With that said, we want to introduce the successors and replacements; Fast Aggregations on top of Query infrastructure and the Hazelcast Jet distributed computing platform.

##### Built-In Aggregations

MapReduce is a very powerful tool, however it's demanding in terms of space, time and bandwidth. We realized that we don't need so much power when we simply want to find out a simple metric such as the number of entries matching a predicate. Therefore, the built-in aggregations were rebuilt on top of the existing Query infrastructure (count, sum, min, max, mean, variance) which

automatically leverages any matching query index. The aggregations are computed in the phases:

- 1st phase: on each member (scatter)
- 2nd phase: one member aggregates responses from members (gather)

It is not as flexible as a full-blown M/R system due to the 2nd phase being single-member and the input can be massive in some use cases. The member doing the 2nd step needs enough capacity to hold all intermediate results from all members from the 1st step, but in practice it is sufficient for many aggregation tasks like "find average" or "find highest" and other common examples.

The benefits are:

- Improved performance
- Simplified API
- Utilization of existing indexes

You can refer to [Fast Aggregations](#) for examples. If you need a more powerful tool like MapReduce, then there is Hazelcast Jet!

### **Distributed Computation with Jet**

Hazelcast Jet is the new distributed computing framework build on top of Hazelcast IMDG. It uses directed acyclic graphs (DAG) to model relationships between individual steps in the data processing pipeline. Conceptually speaking, the MapReduce model simply states that distributed computation on a large dataset can be boiled down to two kinds of computation steps - a map step and a reduce step. One pair of map and reduce does one level of aggregation over data. Complex computations typically require multiple such steps. Multiple M/R-steps essentially form a DAG of operations, so that a DAG execution model boils down to a generalization of the MapReduce model. Therefore it is always possible to rewrite a MapReduce application to Hazelcast Jet DAG or "pipeline of tasks" without conceptual changes.

Benefits:

- M/R steps are completely isolated (by definition). With the whole computation modeled as a DAG, the Jet scheduler can optimize the operation pipeline
- Hazelcast Jet provides a convenient high-level API (distributed `j.u.stream`). The code stays compact but also offers a more concrete API to leverage the full power of DAGs.

### **Moving MapReduce Tasks to Hazelcast Jet**

We'll use the example of the "word count" application which summarizes a set of documents into a mapping from each word to the total number of its occurrences in the documents. This involves both a mapping stage where one document is transformed into a stream of words and a reducing stage that performs a COUNT DISTINCT operation on the stream and populates a Hazelcast IMap with the results.

This is the word count code in MapReduce (also available on [hazelcast-jet-code-samples](#)):

```

JobTracker t = hz.getJobTracker("word-count");
IMap<Long, String> documents = hz.getMap("documents");
LongSumAggregation<String, String> aggr = new LongSumAggregation<>();
Map<String, Long> counts =
    t.newJob(KeyValueSource.fromMap(documents))
      .mapper((Long x, String document, Context<String, Long> ctx) ->
        Stream.of(document.toLowerCase().split("\\W+"))
          .filter(w -> !w.isEmpty())
          .forEach(w -> ctx.emit(w, 1L)))
      .combiner(aggr.getCombinerFactory())
      .reducer(aggr.getReducerFactory())
      .submit()
      .get();

```

Jet's Core API is strictly lower-level than MapReduce's because it can be used to build the entire infrastructure that can drive MapReduce's mapper, combiner and reducer, fully preserving the semantics of the MapReduce job. However, this approach to migrating your code to Jet is not a good option because the MapReduce API enforces a quite suboptimal computation model. The simplest approach is implementing the job in terms of Jet's `java.util.stream` support (Jet JUS for short):

```

IStreamMap<String, String> documents = jet.getMap("documents");
IMap<String, Long> counts = documents
    .stream()
    .flatMap(m -> Stream.of(m.getValue().toLowerCase().split("\\W+"))
      .filter(w -> !w.isEmpty()))
    .collect(DistributedCollectors.toIMap(w -> w, w -> 1L, (left, right) -> left +
right));

```

This can be taken as a general template to express a MapReduce job in terms of Jet JUS: the logic of the mapper is inside `flatMap` and the logic of both the combiner and the reducer is inside `collect`. Jet will automatically apply the optimization where the data stream is first "combined" locally on each member, then the partial results "reduced" in the final step, after sending across the network.

Keep in mind that MapReduce and `java.util.stream` use the same terminology, but with quite different meaning: in JUS the final step is called "combine" (MapReduce calls it "reduce") and the middle step is called "reduce" (MapReduce calls this one "combine"). MapReduce's "combine" collapses the stream in fixed-size batches, whereas in Jet JUS "reduce" collapses the complete local dataset and sends just a single item per distinct key to the final step. In Jet JUS, the final "combine" step combines just one partial result per member into the total result, whereas in MR the final step "reduces" all the one-per-batch items to the final result. Therefore, in Jet there are only  $O(\text{distinct-key-count})$  items sent over the network whereas in MapReduce it is still  $O(\text{total-item-count})$  with just a linear scaling factor equal to the configured batch size.

A complete example of the word count done with the Streams API can be found in the `hazelcast-jet-code-samples` repository, located in the "java.util.stream/wordcount-j.u.s" module in the file `WordCount.java`. A minor difference is that the code on GitHub stores the documents line by line, with the effect of a finer-grained distribution across the cluster.

To better understand how the JUS pipeline is executed by Jet, take a look at the file `WordCount.java` in the "core/wordcount" module, which builds the same DAG as the Jet JUS implementation, but using the Jet Core API. Here is a somewhat simplified DAG from this sample:

```
DAG dag = new DAG();
Vertex source = dag.newVertex("source", Processors.readMap("documents"))
    .localParallelism(1);
Vertex map = dag.newVertex("map", Processors.flatMap(
    (String document) -> traverseArray(document.split("\\W+"))));
Vertex reduce = dag.newVertex("reduce", Processors.groupAndAccumulate(
    () -> 0L, (count, x) -> count + 1));
Vertex combine = dag.newVertex("combine", Processors.groupAndAccumulate(
    Entry::getKey,
    () -> 0L,
    (Long count, Entry<String, Long> wordAndCount) ->
        count + wordAndCount.getValue()));
);
Vertex sink = dag.newVertex("sink", writeMap("counts"));

dag.edge(between(source, map))
    .edge(between(map, reduce).partitioned(wholeItem(), HASH_CODE))
    .edge(between(reduce, combine).partitioned(entryKey()).distributed())
    .edge(between(combine, sink));
```

It is a simple cascade of vertices: `source` → `map` → `reduce` → `combine` → `sink` and matches quite closely the workflow of a MapReduce job. On each member, a distinct slice of data (IMap partitions stored locally) is ingested by the source vertex and sent to map on the local member. The output of map are words and they travel over a partitioned edge to reduce. Note that, as opposed to MapReduce, a single instance of a processor doesn't count occurrences of just one word, but is responsible for entire partitions. There are only as many processors as configured by the `localParallelism` property. This is one of several examples where Jet's DAG exposes performance-critical attributes of the computation to the user.

Another example of this can be seen in arguments passed to `partitioned(wholeItem(), HASH_CODE)`. The user has precise control over the partitioning key as well as the algorithm used to map the key to a partition ID. In this case we use the whole item (the word) as the key and apply the fast `HASH_CODE` strategy, which derives the partition ID from the object's `hashCode()`.

The `reduce` → `combine` edge is both partitioned and distributed. Whereas each cluster member has its own reduce processor for any given word, there is only one combine processor in the entire cluster for a given word. This is where network traffic happens: reduce sends its local results for a word to that one combine processor in the cluster. Note that here we didn't specify `HASH_CODE`: it is not guaranteed to be safe on a distributed edge because on the target member the hashcode can come out differently. For many value classes (like `String` and `Integer`) it is guaranteed to work, though, because their `hashCode` explicitly specifies the function used. By default Jet applies the slower but safer Hazelcast strategy: 1. serialize, 2. compute the MurmurHash3 of the resulting blob. It is up to the user to ensure that the faster strategy is safe, or to provide a custom strategy.

In the above example we can see many out-of-the-box processors being used:

- readMap to ingest the data from an IMap
- flatMap to perform a flat-map operation on incoming items (closely corresponds to MapReduce's mapper)
- groupAndAccumulate to perform the reduction and combining

There are some more in the Processors class. For even more flexibility we'll now show how you can implement a processor on your own (also available in the Code Samples repository):

```
public class MapReduce {

    public static void main(String[] args) throws Exception {
        Jet.newJetInstance();
        JetInstance jet = Jet.newJetInstance();
        try {
            DAG dag = new DAG();
            Vertex source = dag.newVertex("source", readMap("sourceMap"));
            Vertex map = dag.newVertex("map", MapP::new);
            Vertex reduce = dag.newVertex("reduce", ReduceP::new);
            Vertex combine = dag.newVertex("combine", CombineP::new);
            Vertex sink = dag.newVertex("sink", writeMap("sinkMap"));
            dag.edge(between(source, map))
                .edge(between(map, reduce).partitioned(wholeItem(), HASH_CODE))
                .edge(between(reduce, combine).partitioned(entryKey()).distributed())
                .edge(between(combine, sink.localParallelism(1)));
            jet.newJob(dag).execute().get();
        } finally {
            Jet.shutdownAll();
        }
    }

    private static class MapP extends AbstractProcessor {
        private final FlatMapper<Entry<Long, String>, String> flatMapper = flatMapper(
            (Entry<Long, String> e) -> new WordTraverser(e.getValue())
        );

        @Override
        protected boolean tryProcess0(@Nonnull Object item) {
            return flatMapper.tryProcess((Entry<Long, String>) item);
        }
    }

    private static class WordTraverser implements Traverser<String> {

        private final StringTokenizer tokenizer;

        WordTraverser(String document) {
            this.tokenizer = new StringTokenizer(document.toLowerCase());
        }
    }
}
```

```

@Override
public String next() {
    return tokenizer.hasMoreTokens() ? tokenizer.nextToken() : null;
}
}

private static class ReduceP extends AbstractProcessor {
    private final Map<String, Long> wordToCount = new HashMap<>();
    private final Traverser<Entry<String, Long>> resultTraverser =
        lazy(() -> traverseIterable(wordToCount.entrySet()));

    @Override
    protected boolean tryProcess0(@Nonnull Object item) {
        wordToCount.compute((String) item, (x, count) -> 1 + (count != null ?
count : 0L));
        return true;
    }

    @Override
    public boolean complete() {
        return emitCooperatively(resultTraverser);
    }
}

private static class CombineP extends AbstractProcessor {
    private final Map<String, Long> wordToCount = new HashMap<>();
    private final Traverser<Entry<String, Long>> resultTraverser =
        lazy(() -> traverseIterable(wordToCount.entrySet()));

    @Override
    protected boolean tryProcess0(@Nonnull Object item) {
        final Entry<String, Long> e = (Entry<String, Long>) item;
        wordToCount.compute(e.getKey(),
            (x, count) -> e.getValue() + (count != null ? count : 0L));
        return true;
    }

    @Override
    public boolean complete() {
        return emitCooperatively(resultTraverser);
    }
}
}
}

```

One of the challenges of implementing a custom Processor is cooperativeness: it must back off as soon as there is no more room in the output buffer (the outbox). This example shows how to make use of another line of convenience provided at this lower level, which takes care of almost all the mechanics involved. One gotcha is that a simple for-loop must be converted to a stateful iterator-style object, like `WordTraverser` in the above code. To make this conversion as painless as possible we chose to not require a Java Iterator, but defined our own `Traverser` interface with just a single

method to implement. This means that Traverser is a functional interface and can often be implemented with a one-liner lambda.

## Jet Compared with New Aggregations

Hazelcast has native support for aggregation operations on the contents of its distributed data structures. They operate on the assumption that the aggregating function is commutative and associative, which allows the two-tiered approach where first the local data is aggregated, then all the local subresults sent to one member, where they are combined and returned to the user. This approach works quite well as long as the result is of manageable size. Many interesting aggregations produce an  $O(1)$  result and for those, the native aggregations are a good match.

The main area where native aggregations may not be sufficient are operations that group the data by key and produce results of size  $O(\text{keyCount})$ . The architecture of Hazelcast aggregations is not well adapted to this use case, although it will still work even for moderately-sized results (up to 100 MB, as a ballpark figure). Beyond these numbers, and whenever something more than a single aggregation step is needed, Jet becomes the preferred choice. In the mentioned use case Jet helps because it doesn't send entire hashtables in serialized form and materialize all the results on the user's machine, but rather streams the key-value pairs directly into a target IMap. Since it is a distributed structure, it doesn't focus its load on a single member.

Jet's DAG paradigm offers much more than the basic map-reduce-combine cascade. Among other setups it can compose several such cascades and also perform co-grouping, joining and many other operations in complex combinations.

## 11.5. Aggregators



This feature has been deprecated. Please use the [Fast-Aggregations](#) instead.

Based on the Hazelcast MapReduce framework, Aggregators are ready-to-use data aggregations. These are typical operations like sum up values, finding minimum or maximum values, calculating averages and other operations that you would expect in the relational database world.

Aggregation operations are implemented, as mentioned above, on top of the MapReduce framework. All operations can be achieved using pure MapReduce calls. However, using the Aggregation feature is more convenient for a big set of standard operations.

### 11.5.1. Aggregations Basics

This section will quickly guide you through the basics of the Aggregations framework and some of its available classes. We also will implement a first base example.

#### Aggregations and Map Interfaces

Aggregations are available on both types of map interfaces, `com.hazelcast.core.IMap` and `com.hazelcast.core.MultiMap`, using the `aggregate` methods. Two overloaded methods are available that customize resource management of the underlying MapReduce framework by supplying a custom configured `com.hazelcast.mapreduce.JobTracker` instance. To find out how to configure the MapReduce framework, please see [Configuring JobTracker](#). We will later see another way to



configure the automatically used MapReduce framework if no special `JobTracker` is supplied.

## Aggregations and Java

To make Aggregations more convenient to use and future proof, the API is heavily optimized for Java 8 and future versions. The API is still fully compatible with any Java version Hazelcast supports (Java 6 and Java 7). The biggest difference is how you work with the Java generics: on Java 6 and 7, the process to resolve generics is not as strong as on Java 8 and future Java versions. In addition, the whole Aggregations API has full Java 8 Project Lambda (or Closure, [JSR 335](#)) support.

For illustration of the differences in Java 6 and 7 in comparison to Java 8, we will have a quick look at code examples for both. After that, we will focus on using Java 8 syntax to keep examples short and easy to understand. We will see some hints about what the code looks like in Java 6 or 7.

The first example will produce the sum of some `int` values stored in a Hazelcast IMap. This example does not use much of the functionality of the Aggregations framework, but it will show the main difference.

```
IMap<String, Integer> personAgeMapping = hazelcastInstance.getMap( "person-age" );
for ( int i = 0; i < 1000; i++ ) {
    String lastName = RandomUtil.randomLastName();
    int age = RandomUtil.randomAgeBetween( 20, 80 );
    personAgeMapping.put( lastName, Integer.valueOf( age ) );
}
```

With our demo data prepared, we can see how to produce the sums in different Java versions.

### Aggregations and Java 6 or Java 7

Since Java 6 and 7 are not as strong on resolving generics as Java 8, you need to be a bit more verbose with the code you write. You might also consider using raw types but breaking the type safety to ease this process.

For a short introduction on what the following code example means, look at the source code comments. We will later dig deeper into the different options.

```
// No filter applied, select all entries
Supplier<String, Integer, Integer> supplier = Supplier.all();
// Choose the sum aggregation
Aggregation<String, Integer, Integer> aggregation = Aggregations.integerSum();
// Execute the aggregation
int sum = personAgeMapping.aggregate( supplier, aggregation );
```

### Aggregations and Java 8

With Java 8, the Aggregations API looks simpler because Java 8 can resolve the generic parameters for us. That means the above lines of Java 6/7 example code will end up in just one easy line on Java 8.

```
int sum = personAgeMapping.aggregate( Supplier.all(), Aggregations.integerSum() );
```

## Aggregations and the MapReduce Framework

As mentioned before, the Aggregations implementation is based on the Hazelcast MapReduce framework and therefore you might find overlaps in their APIs. One overload of the `aggregate` method can be supplied with a `JobTracker`, which is part of the MapReduce framework.

If you implement your own aggregations, you will use a mixture of the Aggregations and the MapReduce API. If you do so, e.g., to make the life of colleagues easier, please read the [Implementing Aggregations section](#).

### 11.5.2. Using the Aggregations API

We now look into what can be achieved using the Aggregations API. To work on some deeper examples, let's quickly have a look at the available classes and interfaces and discuss their usage.

#### Supplier

The `com.hazelcast.mapreduce.aggregation.Supplier` provides filtering and data extraction to the aggregation operation. This class already provides a few different static methods to achieve the most common cases. `Supplier.all()` accepts all incoming values and does not apply any data extraction or transformation upon them before supplying them to the aggregation function itself.

For filtering data sets, you have two different options by default:

- You can either supply a `com.hazelcast.query.Predicate` if you want to filter on values and/or keys, or
- You can supply a `com.hazelcast.mapreduce.KeyPredicate` if you can decide directly on the data key without the need to deserialize the value.

As mentioned above, all APIs are fully Java 8 and Lambda compatible. Let's have a look on how we can do basic filtering using those two options.

#### Basic Filtering with KeyPredicate

First, we have a look at a `KeyPredicate` and we only accept people whose last name is "Jones".

```
Supplier<...> supplier = Supplier.fromKeyPredicate(  
    lastName -> "Jones".equalsIgnoreCase( lastName )  
);
```

```

class JonesKeyPredicate implements KeyPredicate<String> {
    public boolean evaluate( String key ) {
        return "Jones".equalsIgnoreCase( key );
    }
}

```

### Filtering on Values with Predicate

Using the standard Hazelcast `Predicate` interface, we can also filter based on the value of a data entry. In the following example, you can only select values that are divisible by 4 without a remainder.

```

Supplier<...> supplier = Supplier.fromPredicate(
    entry -> entry.getValue() % 4 == 0
);

```

```

class DivisiblePredicate implements Predicate<String, Integer> {
    public boolean apply( Map.Entry<String, Integer> entry ) {
        return entry.getValue() % 4 == 0;
    }
}

```

### Extracting and Transforming Data

As well as filtering, `Supplier` can also extract or transform data before providing it to the aggregation operation itself. The following example shows how to transform an input value to a string.

```

Supplier<String, Integer, String> supplier = Supplier.all(
    value -> Integer.toString(value)
);

```

You can see a Java 6/7 example in the [Aggregations Examples section](#).

Apart from the fact we transformed the input value of type `int` (or `Integer`) to a string, we can see that the generic information of the resulting `Supplier` has changed as well. This indicates that we now have an aggregation working on string values.

### Chaining Multiple Filtering Rules

Another feature of `Supplier` is its ability to chain multiple filtering rules. Let's combine all of the above examples into one rule set:

```
Supplier<String, Integer, String> supplier =
    Supplier.fromKeyPredicate(
        lastName -> "Jones".equalsIgnoreCase( lastName ),
        Supplier.fromPredicate(
            entry -> entry.getValue() % 4 == 0,
            Supplier.all( value -> Integer.toString(value) )
        )
    );
```

### Implementing Supplier with Special Requirements

You might prefer or need to implement your `Supplier` based on special requirements. This is a very basic task. The `Supplier` abstract class has just one method: the `apply` method.



Due to a limitation of the Java Lambda API, you cannot implement abstract classes using Lambdas. Instead it is recommended that you create a standard named class.

```
class MyCustomSupplier extends Supplier<String, Integer, String> {
    public String apply( Map.Entry<String, Integer> entry ) {
        Integer value = entry.getValue();
        if (value == null) {
            return null;
        }
        return value % 4 == 0 ? String.valueOf( value ) : null;
    }
}
```

The `Supplier apply` methods are expected to return null whenever the input value should not be mapped to the aggregation process. This can be used, as in the example above, to implement filter rules directly. Implementing filters using the `KeyPredicate` and `Predicate` interfaces might be more convenient.

To use your own `Supplier`, just pass it to the aggregate method or use it in combination with other `Supplier`s`.

```
int sum = personAgeMapping.aggregate( new MyCustomSupplier(), Aggregations.count() );
```

```
Supplier<String, Integer, String> supplier =
    Supplier.fromKeyPredicate(
        lastName -> "Jones".equalsIgnoreCase( lastName ),
        new MyCustomSupplier()
    );
int sum = personAgeMapping.aggregate( supplier, Aggregations.count() );
```

## Defining the Aggregation Operation

The `com.hazelcast.mapreduce.aggregation.Aggregation` interface defines the aggregation operation itself. It contains a set of MapReduce API implementations like `Mapper`, `Combiner`, `Reducer` and `Collator`. These implementations are normally unique to the chosen `Aggregation`. This interface can also be implemented with your aggregation operations based on MapReduce calls. For more information, refer to [Implementing Aggregations section](#).

The `com.hazelcast.mapreduce.aggregation.Aggregations` class provides a common predefined set of aggregations. This class contains type safe aggregations of the following types:

- Average (Integer, Long, Double, BigInteger, BigDecimal)
- Sum (Integer, Long, Double, BigInteger, BigDecimal)
- Min (Integer, Long, Double, BigInteger, BigDecimal, Comparable)
- Max (Integer, Long, Double, BigInteger, BigDecimal, Comparable)
- DistinctValues
- Count

Those aggregations are similar to their counterparts on relational databases and can be equated to SQL statements as set out below.

### Average:

Calculates an average value based on all selected values.

```
map.aggregate( Supplier.all( person -> person.getAge() ),
               Aggregations.integerAvg() );
```

```
SELECT AVG(person.age) FROM person;
```

### Sum:

Calculates a sum based on all selected values.

```
map.aggregate( Supplier.all( person -> person.getAge() ),
               Aggregations.integerSum() );
```

```
SELECT SUM(person.age) FROM person;
```

### Minimum (Min):

Finds the minimal value over all selected values.

```
map.aggregate( Supplier.all( person -> person.getAge() ),
              Aggregations.integerMin() );
```

```
SELECT MIN(person.age) FROM person;
```

### Maximum (Max):

Finds the maximal value over all selected values.

```
map.aggregate( Supplier.all( person -> person.getAge() ),
              Aggregations.integerMax() );
```

```
SELECT MAX(person.age) FROM person;
```

### Distinct Values:

Returns a collection of distinct values over the selected values

```
map.aggregate( Supplier.all( person -> person.getAge() ),
              Aggregations.distinctValues() );
```

```
SELECT DISTINCT person.age FROM person;
```

### Count:

Returns the element count over all selected values

```
map.aggregate( Supplier.all(), Aggregations.count() );
```

```
SELECT COUNT(*) FROM person;
```

### Extracting Attribute Values with PropertyExtractor

We used the `com.hazelcast.mapreduce.aggregation.PropertyExtractor` interface before when we had a look at the example on how to use a `Supplier` to [transform a value to another type](#). It can also be used to extract attributes from values.

```

class Person {
    private String firstName;
    private String lastName;
    private int age;

    // getters and setters
}

PropertyExtractor<Person, Integer> propertyExtractor = (person) -> person.getAge();

```

```

class AgeExtractor implements PropertyExtractor<Person, Integer> {
    public Integer extract( Person value ) {
        return value.getAge();
    }
}

```

In this example, we extract the value from the person's age attribute. The value type changes from Person to `Integer` which is reflected in the generics information to stay type safe.

You can use `PropertyExtractor`'s for any kind of transformation of data. You might even want to have multiple transformation steps chained one after another.

### Configuring Aggregations

As stated before, the easiest way to configure the resources used by the underlying MapReduce framework is to supply a `JobTracker` to the aggregation call itself by passing it to either `IMap.aggregate()` or `MultiMap.aggregate()`.

There is another way to implicitly configure the underlying used `JobTracker`. If no specific `JobTracker` was passed for the aggregation call, internally one will be created using the following naming specifications:

For `IMap` aggregation calls the naming specification is created as:

- `hz::aggregation-map-` and the concatenated name of the map.

For `MultiMap` it is very similar:

- `hz::aggregation-multimap-` and the concatenated name of the MultiMap.

Knowing the specification of the name, we can configure the `JobTracker` as expected (as described in [Retrieving a JobTracker Instance](#)) using the naming spec we just learned. For more information on configuration of the `JobTracker`, please see [Configuring Jobtracker](#).

To finish this section, let's have a quick example for the above naming specs:

```
IMap<String, Integer> map = hazelcastInstance.getMap( "mymap" );

// The internal JobTracker name resolves to 'hz::aggregation-map-mymap'
map.aggregate( ... );
```

```
MultiMap<String, Integer> multimap = hazelcastInstance.getMultiMap( "mymultimap" );

// The internal JobTracker name resolves to 'hz::aggregation-multimap-mymultimap'
multimap.aggregate( ... );
```

### 11.5.3. Aggregations Examples

For the final example, imagine you are working for an international company and you have an employee database stored in Hazelcast `IMap` with all employees worldwide and a `MultiMap` for assigning employees to their certain locations or offices. In addition, there is another `IMap` that holds the salary per employee.

#### Setting up the Data Model

Let's have a look at our data model.



```

class Employee implements Serializable {
    private String firstName;
    private String lastName;
    private String companyName;
    private String address;
    private String city;
    private String county;
    private String state;
    private int zip;
    private String phone1;
    private String phone2;
    private String email;
    private String web;

    // getters and setters
}

class SalaryMonth implements Serializable {
    private Month month;
    private int salary;

    // getters and setters
}

class SalaryYear implements Serializable {
    private String email;
    private int year;
    private List<SalaryMonth> months;

    // getters and setters

    public int getAnnualSalary() {
        int sum = 0;
        for ( SalaryMonth salaryMonth : getMonths() ) {
            sum += salaryMonth.getSalary();
        }
        return sum;
    }
}

```

The two `IMap`'s and the `MultiMap` are keyed by the string of email. They are defined as follows:

```

IMap<String, Employee> employees = hz.getMap( "employees" );
IMap<String, SalaryYear> salaries = hz.getMap( "salaries" );
MultiMap<String, String> officeAssignment = hz.getMultiMap( "office-employee" );

```

So far, we know all the important information to work out some example aggregations. We will look into some deeper implementation details and how we can work around some current

limitations that will be eliminated in future versions of the API.

### Average Aggregation Example

Let's start with a very basic example. We want to know the average salary of all of our employees. To do this, we need a `PropertyExtractor` and the average aggregation for type `Integer`.

```
IMap<String, SalaryYear> salaries = hazelcastInstance.getMap( "salaries" );
PropertyExtractor<SalaryYear, Integer> extractor =
    (salaryYear) -> salaryYear.getAnnualSalary();
int avgSalary = salaries.aggregate( Supplier.all( extractor ),
    Aggregations.integerAvg() );
```

That's it. Internally, we created a MapReduce task based on the predefined aggregation and fired it up immediately. Currently all aggregation calls are blocking operations, so it is not yet possible to execute the aggregation in a reactive way (using `com.hazelcast.core.ICompletableFuture`), but this will be part of an upcoming version.

### Map Join Example

The following example is a little more complex. We only want to have our US-based employees selected into the average salary calculation, so we need to execute a join operation between the employees and salaries maps.

```
class USEmployeeFilter implements KeyPredicate<String>, HazelcastInstanceAware {
    private transient HazelcastInstance hazelcastInstance;

    public void setHazelcastInstance( HazelcastInstance hazelcastInstance ) {
        this.hazelcastInstance = hazelcastInstance;
    }

    public boolean evaluate( String email ) {
        IMap<String, Employee> employees = hazelcastInstance.getMap( "employees" );
        Employee employee = employees.get( email );
        return "US".equals( employee.getCountry() );
    }
}
```

Using the `HazelcastInstanceAware` interface, we get the current instance of Hazelcast injected into our filter and we can perform data joins on other data structures of the cluster. We now only select employees that work as part of our US offices into the aggregation.

```

IMap<String, SalaryYear> salaries = hazelcastInstance.getMap( "salaries" );
PropertyExtractor<SalaryYear, Integer> extractor =
    (salaryYear) -> salaryYear.getAnnualSalary();
int avgSalary = salaries.aggregate( Supplier.fromKeyPredicate(
    new USEmployeeFilter(), extractor
), Aggregations.integerAvg() );

```

## Grouping Example

For our next example, we will do some grouping based on the different worldwide offices. Currently, a group aggregator is not yet available, so we need a small workaround to achieve this goal. (In later versions of the Aggregations API this will not be required because it will be available out-of-the-box in a much more convenient way.)

Again, let's start with our filter. This time, we want to filter based on an office name and we need to do some data joins to achieve this kind of filtering.

**A short tip:** to minimize the data transmission on the aggregation we can use [Data Affinity](#) rules to influence the partitioning of data. Be aware that this is an expert feature of Hazelcast.

```

class OfficeEmployeeFilter implements KeyPredicate<String>, HazelcastInstanceAware {
    private transient HazelcastInstance hazelcastInstance;
    private String office;

    // Deserialization Constructor
    public OfficeEmployeeFilter() {
    }

    public OfficeEmployeeFilter( String office ) {
        this.office = office;
    }

    public void setHazelcastInstance( HazelcastInstance hazelcastInstance ) {
        this.hazelcastInstance = hazelcastInstance;
    }

    public boolean evaluate( String email ) {
        MultiMap<String, String> officeAssignment = hazelcastInstance
            .getMultiMap( "office-employee" );

        return officeAssignment.containsEntry( office, email );
    }
}

```

Now we can execute our aggregations. As mentioned before, we currently need to do the grouping on our own by executing multiple aggregations in a row.

```

Map<String, Integer> avgSalariesPerOffice = new HashMap<String, Integer>();

IMap<String, SalaryYear> salaries = hazelcastInstance.getMap( "salaries" );
MultiMap<String, String> officeAssignment =
    hazelcastInstance.getMultiMap( "office-employee" );

PropertyExtractor<SalaryYear, Integer> extractor =
    (salaryYear) -> salaryYear.getAnnualSalary();

for ( String office : officeAssignment.keySet() ) {
    OfficeEmployeeFilter filter = new OfficeEmployeeFilter( office );
    int avgSalary = salaries.aggregate( Supplier.fromKeyPredicate( filter, extractor ),
        Aggregations.integerAvg() );

    avgSalariesPerOffice.put( office, avgSalary );
}

```

### Simple Count Example

We want to end this section by executing one final and easy aggregation. We want to know how many employees we currently have on a worldwide basis. Before reading the next lines of example code, you can try to do it on your own to see if you understood how to execute aggregations.

```

IMap<String, Employee> employees = hazelcastInstance.getMap( "employees" );
int count = employees.size();

```

Ok, after the quick joke of the previous two code lines, we look at the real two code lines:

```

IMap<String, Employee> employees = hazelcastInstance.getMap( "employees" );
int count = employees.aggregate( Supplier.all(), Aggregations.count() );

```

We now have an overview of how to use aggregations in real life situations. If you want to do your colleagues a favor, you might want to write your own additional set of aggregations. If so, then read the next section, [Implementing Aggregations](#).

### 11.5.4. Implementing Aggregations

This section explains how to implement your own aggregations in your own application. It is an advanced section, so if you do not intend to implement your own aggregation, you might want to stop reading here and come back later when you need to know how to implement your own aggregation.

An **Aggregation** implementation is defining a MapReduce task, but with a small difference: the **Mapper** is always expected to work on a **Supplier** that filters and/or transforms the mapped input value to some output value.

## Aggregation Methods

The main interface for making your own aggregation is `com.hazelcast.mapreduce.aggregation.Aggregation`. It consists of four methods.

```
interface Aggregation<Key, Supplied, Result> {
    Mapper getMapper(Supplier<Key, ?, Supplied> supplier);
    CombinerFactory getCombinerFactory();
    ReducerFactory getReducerFactory();
    Collator<Map.Entry, Result> getCollator();
}
```

The `getMapper` and `getReducerFactory` methods should return non-null values. `getCombinerFactory` and `getCollator` are optional operations and you do not need to implement them. You can decide to implement them depending on the use case you want to achieve.

## 11.6. Fast-Aggregations

Fast-Aggregations functionality is the successor of the [Aggregators](#). They are equivalent to the MapReduce Aggregators in most of the use cases, but instead of running on the MapReduce engine they run on the Query infrastructure. Their performance is tens to hundreds times better since they run in parallel for each partition and are highly optimized for speed and low memory consumption.



If the [\[setting-in-memory-format in-memory format\]](#) of your data is `NATIVE`, Fast-Aggregations always run on the partition threads. If the data is of type `BINARY` or `OBJECT`, they also mostly run on the partition threads, however, they may run on the separate query threads to avoid blocking partition threads (if there are no ongoing migrations).

### 11.6.1. Aggregator API

The Fast-Aggregation consists of three phases represented by three methods:

- `accumulate()`,
- `combine()`,
- `aggregate()`.

There are also two callbacks:

- `onAccumulationFinished()` called when the accumulation phase finishes.
- `onCombinationFinished()` called when the combination phase finishes.

These callbacks enable releasing the state that might have been initialized and stored in the Aggregator - to reduce the network traffic.

Each phase is described below and you can also refer to the [Aggregator Javadoc](#) for the API's

details.

### **Accumulation:**

During the accumulation phase each Aggregator accumulates all entries passed to it by the query engine. It accumulates only those pieces of information that are required to calculate the aggregation result in the last phase - that's implementation specific.

In case of the `DoubleAverage` aggregation the Aggregator would accumulate:

- the sum of the elements it accumulated
- the count of the elements it accumulated

### **Combination:**

Since Fast-Aggregation is executed in parallel on each partition of the cluster, the results need to be combined after the accumulation phase in order to be able to calculate the final result.

In case of the `DoubleAverage` aggregation, the aggregator would sum up all the sums of the elements and all the counts.

### **Aggregation:**

Aggregation is the last phase that calculates the final result from the results accumulated and combined in the preceding phases.

In case of the `DoubleAverage` aggregation, the Aggregator would just divide the sum of the elements by their count (if non-zero).

## **11.6.2. Fast-Aggregations and Map Interfaces**

Fast-Aggregations are available on `com.hazelcast.core.IMap` only. `IMap` offers the method `aggregate` to apply the aggregation logic on the map entries. This method can be called with or without a predicate. You can refer to its [Javadoc](#) to see the method details.

## **11.6.3. Sample Implementation**

Here's a sample implementation of the Aggregator:

```

private static void simpleCustomAverageAggregation(IMap<String, FAEmployee> employees)
{
    System.out.println("Calculating salary average");

    double avgSalary = employees.aggregate(new Aggregator<Map.Entry<String,
FAEmployee>, Double>() {

        protected long sum;
        protected long count;

        @Override
        public void accumulate(Map.Entry<String, FAEmployee> entry) {
            count++;
            sum += entry.getValue().getSalaryPerMonth();
        }

        @Override
        public void combine(Aggregator aggregator) {

            this.sum += this.getClass().cast(aggregator).sum;
            this.count += this.getClass().cast(aggregator).count;
        }

        @Override
        public Double aggregate() {
            if (count == 0) {
                return null;
            }
            return ((double) sum / (double) count);
        }

    });

    System.out.println("Overall average salary: " + avgSalary);
    System.out.println("\n");
}

```

As you can see:

- the `accumulate()` method calculates the sum and the count of the elements.
- the `combine()` method combines the results from all the accumulations.
- the `aggregate()` method calculates the final result.

#### 11.6.4. Built-In Aggregations

The `com.hazelcast.aggregation.Aggregators` class provides a wide variety of built-in Aggregators. The full list is presented below:

- count

- `distinct`
- `BigDecimal sum/avg/min/max`
- `BigInteger sum/avg/min/max`
- `double sum/avg/min/max`
- `integer sum/avg/min/max`
- `long sum/avg/min/max`
- `number avg`
- `comparable min/max`
- `fixedPointSum, floatingPointSum`

To use any of these Aggregators, instantiate them using the `Aggregators` factory class.

Each built-in Aggregator can also navigate to an attribute of the object passed to the `accumulate()` method (via reflection). For example, `Aggregators.distinct("address.city")` will extract the `address.city` attribute from the object passed to the Aggregator and accumulate the extracted value.

### 11.6.5. Configuration Options

On each partition, after the entries have been passed to the aggregator, the accumulation runs in parallel. It means that each aggregator is cloned and receives a sub-set of the entries received from a partition. Then, it runs the accumulation phase in all of the cloned aggregators - at the end, the result is combined into a single accumulation result. It speeds up the processing by at least the factor of two - even in case of simple aggregations. If the accumulation logic is more "heavy", the speed-up may be more significant.

In order to switch the accumulation into a sequential mode just set the `hazelcast.aggregation.accumulation.parallel.evaluation` property to `false` (it's set to `true` by default).

## 11.7. Projections

There are cases where instead of sending all the data returned by a query from a member, you want to transform (strip down) each result object in order to avoid redundant network traffic.

For example, you select all employees based on some criteria, but you just want to return their name instead of the whole Employee object. It is easily doable with the Projection API.

### 11.7.1. Projection API

The Projection API provides the method `transform()` which is called on each result object. Its result is then gathered as the final query result entity. You can refer to the [Projection Javadoc](#) for the API's details.

#### Projections and Map Interfaces

Projections are available on `com.hazelcast.core.IMap` only. `IMap` offers the method `project` to apply



the projection logic on the map entries. This method can be called with or without a predicate. You can refer to its [Javadoc](#) to see the method details.

### 11.7.2. Sample implementation

Let's consider the following domain object stored in an IMap:

```
public class Employee implements Serializable {  
  
    private String name;  
  
    public Employee() {  
    }  
  
    public String getName() {  
        return name;  
    }  
  
    public void setName(String firstName) {  
        this.name = name;  
    }  
}
```

To return just the names of the Employees, you can run the query in the following way:

```
Collection<String> names = employees.project(new Projection<Map.Entry<String,  
Employee>, String>() {  
  
    @Override  
    public String transform(Map.Entry<String, Employee> entry) {  
        return entry.getValue().getName();  
    }  
}, somePredicate);
```

### 11.7.3. Built-In Projections

The `com.hazelcast.projection.Projections` class provides two built-in Projections:

- `singleAttribute`
- `multiAttribute`

The `singleAttribute` Projection enables extracting a single attribute from an object (via reflection). For example, `Projection.singleAttribute("address.city")` will extract the `address.city` attribute from the object passed to the Projection.

The `multiAttribute` Projection enables extracting multiples attributes from an object (via reflection). For example, `Projection.multiAttribute("address.city", "postalAddress.city")` will extract both attributes from the object passed to the Projection and return them in an `Object[]`

array.

## 11.8. Continuous Query Cache

A continuous query cache is used to cache the result of a continuous query. After the construction of a continuous query cache, all changes on the underlying `IMap` are immediately reflected to this cache as a stream of events. Therefore, this cache will be an always up-to-date view of the `IMap`. You can create a continuous query cache either on the client or member.

### 11.8.1. Keeping Query Results Local and Ready

A continuous query cache is beneficial when you need to query the distributed `IMap` data in a very frequent and fast way. By using a continuous query cache, the result of the query will always be ready and local to the application.

### 11.8.2. Accessing Continuous Query Cache from Member

The following code snippet shows how you can access a continuous query cache from a member.

```
QueryCacheConfig queryCacheConfig = new QueryCacheConfig("cache-name");
queryCacheConfig.getPredicateConfig().setImplementation(new OddKeysPredicate());

MapConfig mapConfig = new MapConfig("map-name");
mapConfig.addQueryCacheConfig(queryCacheConfig);

Config config = new Config();
config.addMapConfig(mapConfig);

HazelcastInstance node = Hazelcast.newHazelcastInstance(config);
IMap<Integer, String> map = (IMap) node.getMap("map-name");
```

### 11.8.3. Accessing Continuous Query Cache from Client Side

The following code snippet shows how you can access a continuous query cache from the client side. The difference in this code from the member side code above is that you configure and instantiate a client instance instead of a member instance.

```
QueryCacheConfig queryCacheConfig = new QueryCacheConfig("cache-name");
queryCacheConfig.getPredicateConfig().setImplementation(new OddKeysPredicate());

ClientConfig clientConfig = new ClientConfig();
clientConfig.addQueryCacheConfig("map-name", queryCacheConfig);

HazelcastInstance client = HazelcastClient.newHazelcastClient(clientConfig);
IMap<Integer, Integer> clientMap = (IMap) client.getMap("map-name");

QueryCache<Integer, Integer> cache = clientMap.getQueryCache("cache-name");
```

## 11.8.4. Features of Continuous Query Cache

The following features of continuous query cache are valid for both the member and client.

- The initial query that is run on the existing `IMap` data during the continuous query cache construction can be enabled/disabled according to the supplied predicate via `QueryCacheConfig.setPopulate()`.
- Continuous query cache allows you to run queries with indexes and perform event batching and coalescing.
- A continuous query cache is evictable. Note that a continuous query cache has a default maximum capacity of 10000. If you need a non-evictable cache, you should configure the eviction via `QueryCacheConfig.setEvictionConfig()`.
- A listener can be added to a continuous query cache using `QueryCache.addEntryListener()`.
- `IMap` events are reflected in continuous query cache in the same order as they were generated on map entries. Since events are created on entries stored in partitions, ordering of events is maintained based on the ordering within the partition. You can add listeners to capture lost events using `EventLostListener` and you can recover lost events with the method `QueryCache.tryRecover()`. Recovery of lost events largely depends on the size of the buffer on Hazelcast members. Default buffer size is 16 per partition; i.e. 16 events per partition can be maintained in the buffer. If the event generation is high, setting the buffer size to a higher number will provide better chances of recovering lost events. You can set buffer size with `QueryCacheConfig.setBufferSize()`. You can use the following example code for a recovery case.

```
QueryCache queryCache = map.getQueryCache("cache-name", new SqlPredicate("this >
20"), true);
queryCache.addEntryListener(new EventLostListener() {
    @Override
    public void eventLost(EventLostEvent event) {
        queryCache.tryRecover();
    }
}, false);
```

- You can populate a continuous query cache with only the keys of its entries and retrieve the subsequent values directly via `QueryCache.get()` from the underlying `IMap`. This helps to decrease the initial population time when the values are very large.

## 11.8.5. Configuring Continuous Query Cache

You can configure continuous query cache declaratively or programmatically; the latter is mostly explained in the previous section. The parent configuration element is `<query-caches>` which should be placed within your `<map>` configuration. You can create your query caches using the `<query-cache>` sub-element under `<query-caches>`.

The following is an example declarative configuration.

```

<map>
  <query-caches>
    <query-cache name="myContQueryCache">
      <include-value>true</include-value>
      <predicate type="class-name">
com.hazelcast.examples.ExamplePredicate</predicate>
      <entry-listeners>
        <entry-listener>...</entry-listener>
      </entry-listeners>
      <in-memory-format>BINARY</in-memory-format>
      <populate>true</populate>
      <coalesce>>false</coalesce>
      <batch-size>2</batch-size>
      <delay-seconds>3</delay-seconds>
      <buffer-size>32</buffer-size>
      <eviction size="1000" max-size-policy="ENTRY_COUNT" eviction-policy="LFU"/>
      <indexes>
        <index ordered="true">...</index>
      </indexes>
    </query-cache>
  </query-caches>
</map>

```

Here are the descriptions of configuration elements and attributes:

- **name**: Name of your continuous query cache.
- **include-value**: Specifies whether the value will be cached too. Its default value is true.
- **predicate**: Predicate to filter events which will be applied to the query cache.
- **entry-listeners**: Adds listeners (listener classes) for your query cache entries. Please see the [Registering Map Listeners](#) section.
- **in-memory-format**: Type of the data to be stored in your query cache. Please see the [Setting In-Memory Format](#) section. Its default value is BINARY.
- **populate**: Specifies whether the initial population of your query cache is enabled. Its default value is true.
- **coalesce**: Specifies whether the coalescing of your query cache is enabled. Its default value is false.
- **delay-seconds**: Minimum time in seconds that an event waits in the member's buffer. Its default value is 0.
- **batch-size**: Batch size used to determine the number of events sent in a batch to your query cache. Its default value is 1.
- **buffer-size**: Maximum number of events which can be stored in a partition buffer. Its default value is 16.
- **eviction**: Configuration for the eviction of your query cache. Please see the [Configuring Map Eviction](#) section.

- **indexes**: Indexes for your query cache defined by using this element's `<index>` sub-elements. Please see the [Configuring IMap Indexes section](#).

Please take the following configuration considerations and publishing logic into account:

If **delay-seconds** is equal to or smaller than **0**, then **batch-size** loses its function. Each time there is an event, all the entries in the buffer are pushed to the subscriber.

If **delay-seconds** is bigger than **0**, the following logic applies:

- If **coalesce** is set to **true**, the buffer is checked for an event with the same key; if so, it is overridden by the current event. Then:
  - The current size of the buffer is checked: if the current size of the buffer is equal to or larger than **batch-size**, then the events counted as much as the **batch-size** are pushed to the subscriber. Otherwise, no events are sent.
  - After finishing with checking **batch-size**, the **delay-seconds** is checked. The buffer is scanned from the oldest to youngest entries; all the entries that are older than **delay-seconds** are pushed to the subscriber.

## 12. Transactions

This chapter explains the usage of Hazelcast in a transactional context. It describes the Hazelcast transaction types and how they work, how to provide XA (eXtended Architecture) transactions and how to integrate Hazelcast with J2EE containers.

### 12.1. Creating a Transaction Interface

You create a `TransactionContext` object to begin, commit and rollback a transaction. You can obtain transaction-aware instances of queues, maps, sets, lists and multimaps via `TransactionContext`, work with them and commit/rollback in one shot. You can see the [TransactionContext API here](#).

Hazelcast supports two types of transactions: `ONE_PHASE` and `TWO_PHASE`. The type of transaction controls what happens when a member crashes while a transaction is committing. The default behavior is `TWO_PHASE`.



Starting with Hazelcast 3.6, the transaction type `LOCAL` has been deprecated. Please use `ONE_PHASE` for the Hazelcast releases 3.6 and higher.

- **ONE\_PHASE**: By selecting this transaction type, you execute the transactions with a single phase that is committing the changes. Since a preparing phase does not exist, the conflicts are not detected. When a conflict happens while committing the changes, e.g., due to a member crash, not all the changes are written and this leaves the system in an inconsistent state.
- **TWO\_PHASE**: When you select this transaction type, Hazelcast first tries to execute the prepare phase. This phase fails if there are any conflicts. Once the prepare phase is successful, Hazelcast executes the commit phase (writing the changes). Before `TWO_PHASE` commits, Hazelcast copies the commit log to other members, so in case of a member failure, another member can complete the commit.

```

public class TransactionalMember {

    public static void main(String[] args) throws Exception {
        HazelcastInstance hazelcastInstance = Hazelcast.newHazelcastInstance();

        TransactionOptions options = new TransactionOptions()
            .setTransactionType( TransactionOptions.TransactionType.ONE_PHASE );

        TransactionContext context = hazelcastInstance.newTransactionContext( options
);
        context.beginTransaction();

        TransactionalQueue queue = context.getQueue( "myqueue" );
        TransactionalMap map = context.getMap( "mymap" );
        TransactionalSet set = context.getSet( "myset" );

        try {
            Object obj = queue.poll();
            //process obj
            map.put( "1", "value1" );
            set.add( "value" );
            //do other things
            context.commitTransaction();
        } catch ( Throwable t ) {
            context.rollbackTransaction();
        }
    }
}

```

In a transaction, operations will not be executed immediately. Their changes will be local to the `TransactionContext` until committed. However, they will ensure the changes via locks.

For the above example, when `map.put` is executed, no data will be put in the map but the key will be locked against changes. While committing, operations will be executed, the value will be put to the map and the key will be unlocked.

The isolation level in Hazelcast Transactions is `READ_COMMITTED` on the level of a single partition. If you are in a transaction, you can read the data in your transaction and the data that is already committed. If you are not in a transaction, you can only read the committed data.



The `REPEATABLE_READ` isolation level can also be exercised using the method `getForUpdate()` of `TransactionalMap`.



The isolation levels might be broken if the objects involved in the transaction span multiple partitions. A reader which is not in a transaction can then temporarily observe partially committed data.

### 12.1.1. Queue/Set/List vs. Map/Multimap

Hazelcast implements queue/set/list operations differently than map/multimap operations. For queue operations (offer, poll), offered and/or polled objects are copied to the owner member in order to safely commit/rollback. For map/multimap, Hazelcast first acquires the locks for the write operations (put, remove) and holds the differences (what is added/removed/updated) locally for each transaction. When the transaction is set to commit, Hazelcast will release the locks and apply the differences. When rolling back, Hazelcast will release the locks and discard the differences.

`MapStore` and `QueueStore` do not participate in transactions. Hazelcast will suppress exceptions thrown by the store in a transaction. Please refer to the [XA Transactions section](#) for further information.

### 12.1.2. ONE\_PHASE vs. TWO\_PHASE

As discussed in [Creating a Transaction Interface](#), when you choose ONE\_PHASE as the transaction type, Hazelcast tracks all changes you make locally in a commit log, i.e., a list of changes. In this case, all the other members are asked to agree that the commit can succeed and once they agree, Hazelcast starts to write the changes. However, if the member that initiates the commit crashes after it has written to at least one member (but has not completed writing to all other members), your system may be left in an inconsistent state.

On the other hand, if you choose TWO\_PHASE as the transaction type, the commit log is again tracked locally but it is copied to another cluster member. Therefore, when a failure happens, e.g., the member initiating the commit crashes, you still have the commit log in another member and that member can complete the commit. However, copying the commit log to another member makes the TWO\_PHASE approach slow.

Consequently, it is recommended that you choose ONE\_PHASE as the transaction type if you want better performance, and that you choose TWO\_PHASE if reliability of your system is more important than the performance.



It should be noted that in split-brain situations or during a member failure, Hazelcast might not be able to always hold ACID guarantees.

## 12.2. Providing XA Transactions

XA describes the interface between the global transaction manager and the local resource manager. XA allows multiple resources (such as databases, application servers, message queues, transactional caches, etc.) to be accessed within the same transaction, thereby preserving the ACID properties across applications. XA uses a two-phase commit to ensure that all resources either commit or rollback any particular transaction consistently (all do the same).

When you implement the `XAResource` interface, Hazelcast provides XA transactions. You can obtain the `HazelcastXAResource` instance via the `HazelcastInstance` `getXAResource` method. You can see the [HazelcastXAResource API here](#).

Below is example code that uses JTA API for transaction management.

```

cleanAtomikosLogs();

HazelcastInstance instance = Hazelcast.newHazelcastInstance();
HazelcastXAResource xaResource = instance.getXAResource();

UserTransactionManager tm = new UserTransactionManager();
tm.begin();

Transaction transaction = tm.getTransaction();
transaction.enlistResource(xaResource);
TransactionContext context = xaResource.getTransactionContext();
TransactionalMap<Object, Object> map = context.getMap("map");
map.put("key", "val");
transaction.delistResource(xaResource, XAResource.TMSUCCESS);

tm.commit();

IMap<Object, Object> m = instance.getMap("map");
Object val = m.get("key");
System.out.println("value: " + val);

cleanAtomikosLogs();
Hazelcast.shutdownAll();

```

## 13. Hazelcast JCache

This chapter describes the basics of JCache, the standardized Java caching layer API. The JCache caching API is specified by the Java Community Process (JCP) as Java Specification Request (JSR) 107.

Caching keeps data in memory that either are slow to calculate/process or originate from another underlying backend system. Caching is used to prevent additional request round trips for frequently used data. In both cases, caching can be used to gain performance or decrease application latencies.

### 13.1. JCache Overview

Starting with Hazelcast 3.3.1, Hazelcast offers a specification-compliant JCache implementation. To show our commitment to this important specification that the Java world was waiting for over a decade, we did not just provide a simple wrapper around our existing APIs; we implemented a caching structure from the ground up to optimize the behavior to the needs of JCache. The Hazelcast JCache implementation is 100% TCK (Technology Compatibility Kit) compliant and therefore passes all specification requirements.

In addition to the given specification, we added some features like asynchronous versions of almost all operations to give the user extra power.



This chapter gives a basic understanding of how to configure your application and how to setup Hazelcast to be your JCache provider. It also shows examples of basic JCache usage as well as the additionally offered features that are not part of JSR-107. To gain a full understanding of the JCache functionality and provided guarantees of different operations, read the specification document (which is also the main documentation for functionality) at the specification page of [JSR-107](#).

### 13.1.1. Supported JCache Versions

Two versions of the JCache specification have been released:

- The original release, version 1.0.0, was released in March 2014. Hazelcast versions 3.3.1 up to 3.9.2 (included) implement version 1.0.0 of the JCache specification.
- A maintenance release, version 1.1.0 was released in December 2017. Hazelcast version 3.9.3 and higher implement JCache specification version 1.1.0.

JCache 1.1.0 is backwards compatible with JCache 1.0.0. As a maintenance release, it introduces clarifications and bug fixes in the specification, reference implementation and TCK, without introducing any additional features.

### 13.1.2. Upgrading from JCache 1.0.0 to 1.1.0

When upgrading from a Hazelcast version which implements JCache 1.0.0 to a version that implements version 1.1.0 of the specification, some behavioral differences must be taken into account:

- Invoking `CacheManager.getCacheNames` on a closed `CacheManager` will return an empty iterator under JCache 1.0.0, while under JCache 1.1.0 will throw an `IllegalStateException`.
- Runtime type checking is removed from `CacheManager.getCache(String)`, so when using JCache 1.1.0 one may obtain a `Cache` by name even when its configured key/value types are not known.
- Statistics effects of `Cache.putIfAbsent` on misses and hits are properly applied when using JCache 1.1.0, while under JCache 1.0.0 misses and hits were not updated.

Note that these behavioral differences apply on the Hazelcast member that executes the operation. Thus when performing a rolling member upgrade from a JCache 1.0.0-compliant Hazelcast version to a newer Hazelcast version that supports JCache 1.1.0, operations executed on the new members will exhibit JCache 1.1.0 behavior while those executed on old members will implement JCache 1.0.0 behavior.

The complete list of issues addressed in JCache specification version 1.1.0 is [available on Github](#).

## 13.2. JCache Setup and Configuration

This section shows what is necessary to provide the JCache API and the Hazelcast JCache implementation for your application. In addition, it demonstrates the different configuration options and describes the configuration properties.

### 13.2.1. Setting up Your Application

To provide your application with this JCache functionality, your application needs the JCache API inside its classpath. This API is the bridge between the specified JCache standard and the implementation provided by Hazelcast.

The method of integrating the JCache API JAR into the application classpath depends on the build system used. For Maven, Gradle, SBT, Ivy and many other build systems, all using Maven-based dependency repositories, perform the integration by adding the Maven coordinates to the build descriptor.

As already mentioned, you have to add JCache coordinates next to the default Hazelcast coordinates that might be already part of the application.

For Maven users, the coordinates look like the following code:

```
<dependency>
  <groupId>javax.cache</groupId>
  <artifactId>cache-api</artifactId>
  <version>1.1.0</version>
</dependency>
```

With other build systems, you might need to describe the coordinates in a different way.

#### Activating Hazelcast as JCache Provider

To activate Hazelcast as the JCache provider implementation, add either `hazelcast-all.jar` or `hazelcast.jar` to the classpath (if not already available) by either one of the following Maven snippets.

If you use `hazelcast-all.jar`:

```
<dependency>
  <groupId>com.hazelcast</groupId>
  <artifactId>hazelcast-all</artifactId>
  <version>"your Hazelcast version, e.g. 3.10"</version>
</dependency>
```

If you use `hazelcast.jar`:

```
<dependency>
  <groupId>com.hazelcast</groupId>
  <artifactId>hazelcast</artifactId>
  <version>"your Hazelcast version, e.g. 3.10"</version>
</dependency>
```

The users of other build systems have to adjust the definition of the dependency to their needs.

## Connecting Clients to Remote Member

When the users want to use Hazelcast clients to connect to a remote cluster, the `hazelcast-client.jar` dependency is also required on the client side applications. This JAR is already included in `hazelcast-all.jar`. Or, you can add it to the classpath using the following Maven snippet:

```
<dependency>
  <groupId>com.hazelcast</groupId>
  <artifactId>hazelcast-client</artifactId>
  <version>"your Hazelcast version, e.g. 3.10"</version>
</dependency>
```

For other build systems, for instance, ANT, the users have to download these dependencies from either the JSR-107 specification and Hazelcast community website (<http://www.hazelcast.org>) or from the Maven repository search page (<http://search.maven.org>).

### 13.2.2. Example JCache Application

Before moving on to configuration, let's have a look at a basic introductory example. The following code shows how to use the Hazelcast JCache integration inside an application in an easy but typesafe way.

```
// Retrieve the CachingProvider which is automatically backed by
// the chosen Hazelcast member or client provider.
CachingProvider cachingProvider = Caching.getCachingProvider();

// Create a CacheManager.
CacheManager cacheManager = cachingProvider.getCacheManager();

// Create a simple but typesafe configuration for the cache.
CompleteConfiguration<String, String> config =
    new MutableConfiguration<String, String>()
        .setTypes( String.class, String.class );

// Create and get the cache.
Cache<String, String> cache = cacheManager.createCache( "example", config );
// Alternatively to request an already existing cache:
// Cache<String, String> cache = cacheManager
//     .getCache( name, String.class, String.class );

// Put a value into the cache.
cache.put( "world", "Hello World" );

// Retrieve the value again from the cache.
String value = cache.get( "world" );

// Print the value 'Hello World'.
System.out.println( value );
```

Although the example is simple, let's go through the code lines one by one.

## Getting the Hazelcast JCache Implementation

First of all, we retrieve the `javax.cache.spi.CachingProvider` using the static method from `javax.cache.Caching.getCachingManager()`, which automatically picks up Hazelcast as the underlying JCache implementation, if available in the classpath. This way, the Hazelcast implementation of a `CachingProvider` will automatically start a new Hazelcast member or client (depending on the chosen provider type) and pick up the configuration from either the command line parameter or from the classpath. We will show how to use an existing `HazelcastInstance` later in this chapter; for now, we keep it simple.

## Setting up the JCache Entry Point

In the next line, we ask the `CachingProvider` to return a `javax.cache.CacheManager`. This is the general application's entry point into JCache. The `CacheManager` creates and manages named caches.

## Configuring the Cache Before Creating It

The next few lines create a simple `javax.cache.configuration.MutableConfiguration` to configure the cache before actually creating it. In this case, we only configure the key and value types to make the cache typesafe which is highly recommended and checked on retrieval of the cache.

## Creating the Cache

To create the cache, we call `javax.cache.CacheManager.createCache()` with a name for the cache and the previously created configuration; the call returns the created cache. If you need to retrieve a previously created cache, you can use the corresponding method overload `javax.cache.CacheManager.getCache()`. If the cache was created using type parameters, you must retrieve the cache afterward using the type checking version of `getCache`.

## get, put and getAndPut

The following lines are simple `put` and `get` calls from the `java.util.Map` interface. The `javax.cache.Cache.put()` has a `void` return type and does not return the previously assigned value of the key. To imitate the `java.util.Map.put()` method, the JCache cache has a method called `getAndPut`.

### 13.2.3. Configuring for JCache

Hazelcast JCache provides two different methods for cache configuration:

- programmatically: the typical Hazelcast way, using the Config API seen above
- declaratively: using `hazelcast.xml` or `hazelcast-client.xml`

## JCache Declarative Configuration

You can declare your JCache cache configuration using the `hazelcast.xml` or `hazelcast-client.xml` configuration files. Using this declarative configuration makes creating the `javax.cache.Cache` fully transparent and automatically ensures internal thread safety. You do not need a call to `javax.cache.Cache.createCache()` in this case: you can retrieve the cache using

`javax.cache.Cache.getCache()` overloads and by passing in the name defined in the configuration for the cache.

To retrieve the cache that you defined in the declaration files, you need only perform a simple call (example below) because the cache is created automatically by the implementation.

```
CachingProvider cachingProvider = Caching.getCachingProvider();
CacheManager cacheManager = cachingProvider.getCacheManager();
Cache<Object, Object> cache = cacheManager
    .getCache( "default", Object.class, Object.class );
```

Note that this section only describes the JCache provided standard properties. For the Hazelcast specific properties, please see the [ICache Configuration section](#).

```
<cache name="default">
  <key-type class-name="java.lang.Object" />
  <value-type class-name="java.lang.Object" />
  <statistics-enabled>>false</statistics-enabled>
  <management-enabled>>false</management-enabled>

  <read-through>>true</read-through>
  <write-through>>true</write-through>
  <cache-loader-factory
    class-name="com.example.cache.MyCacheLoaderFactory" />
  <cache-writer-factory
    class-name="com.example.cache.MyCacheWriterFactory" />
  <expiry-policy-factory
    class-name="com.example.cache.MyExpiryPolicyFactory" />

  <cache-entry-listeners>
    <cache-entry-listener old-value-required="false" synchronous="false">
      <cache-entry-listener-factory
        class-name="com.example.cache.MyEntryListenerFactory" />
      <cache-entry-event-filter-factory
        class-name="com.example.cache.MyEntryEventFilterFactory" />
    </cache-entry-listener>
    ...
  </cache-entry-listeners>
</cache>
```

- **key-type#class-name**: Fully qualified class name of the cache key type. Its default value is `java.lang.Object`.
- **value-type#class-name**: Fully qualified class name of the cache value type. Its default value is `java.lang.Object`.
- **statistics-enabled**: If set to true, statistics like cache hits and misses are collected. Its default value is false.
- **management-enabled**: If set to true, JMX beans are enabled and collected statistics are provided. It

doesn't automatically enable statistics collection. Its default value is false.

- **read-through**: If set to true, enables read-through behavior of the cache to an underlying configured `javax.cache.integration.CacheLoader` which is also known as lazy-loading. Its default value is false.
- **write-through**: If set to true, enables write-through behavior of the cache to an underlying configured `javax.cache.integration.CacheWriter` which passes any changed value to the external backend resource. Its default value is false.
- **cache-loader-factory#class-name**: Fully qualified class name of the `javax.cache.configuration.Factory` implementation providing a `javax.cache.integration.CacheLoader` instance to the cache.
- **cache-writer-factory#class-name**: Fully qualified class name of the `javax.cache.configuration.Factory` implementation providing a `javax.cache.integration.CacheWriter` instance to the cache.
- **expiry-policy-factory#-class-name**: Fully qualified class name of the `javax.cache.configuration.Factory` implementation providing a `javax.cache.expiry.ExpiryPolicy` instance to the cache.
- **cache-entry-listener**: A set of attributes and elements, explained below, to describe a `javax.cache.event.CacheEntryListener`.
  - **cache-entry-listener#old-value-required**: If set to true, previously assigned values for the affected keys will be sent to the `javax.cache.event.CacheEntryListener` implementation. Setting this attribute to true creates additional traffic. Its default value is false.
  - **cache-entry-listener#synchronous**: If set to true, the `javax.cache.event.CacheEntryListener` implementation will be called in a synchronous manner. Its default value is false.
  - **cache-entry-listener/entry-listener-factory#class-name**: Fully qualified class name of the `javax.cache.configuration.Factory` implementation providing a `javax.cache.event.CacheEntryListener` instance.
  - **cache-entry-listener/entry-event-filter-factory#class-name**: Fully qualified class name of the `javax.cache.configuration.Factory` implementation providing a `javax.cache.event.CacheEntryEventFilter` instance.



The JMX MBeans provided by Hazelcast JCache show statistics of the local member only. To show the cluster-wide statistics, the user should collect statistic information from all members and accumulate them to the overall statistics.

## JCache Programmatic Configuration

To configure the JCache programmatically:

- either instantiate `javax.cache.configuration.MutableConfiguration` if you will use only the JCache standard configuration,
- or instantiate `com.hazelcast.config.CacheConfig` for a deeper Hazelcast integration.

`com.hazelcast.config.CacheConfig` offers additional options that are specific to Hazelcast, such as asynchronous and synchronous backup counts. Both classes share the same supertype interface

`javax.cache.configuration.CompleteConfiguration` which is part of the JCache standard.



To stay vendor independent, try to keep your code as near as possible to the standard JCache API. We recommend that you use declarative configuration and that you use the `javax.cache.configuration.Configuration` or `javax.cache.configuration.CompleteConfiguration` interfaces in your code only when you need to pass the configuration instance throughout your code.

If you don't need to configure Hazelcast specific properties, we recommend that you instantiate `javax.cache.configuration.MutableConfiguration` and that you use the setters to configure Hazelcast as shown in the example in the [Example JCache Application section](#). Since the configurable properties are the same as the ones explained in the [JCache Declarative Configuration section](#), they are not mentioned here. For Hazelcast specific properties, please read the [ICache Configuration section](#).

## 13.3. JCache Providers

Use JCache providers to create caches for a specification compliant implementation. Those providers abstract the platform specific behavior and bindings and provide the different JCache required features.

Hazelcast has two types of providers. Depending on your application setup and the cluster topology, you can use the Client Provider (used by Hazelcast clients) or the Server Provider (used by cluster members).

For more information on cluster topologies and Hazelcast clients, please see the [Hazelcast Topology section](#).

### 13.3.1. Configuring JCache Provider

Configure the JCache `javax.cache.spi.CachingProvider` by either specifying the provider at the command line or by declaring the provider inside the Hazelcast configuration XML file. For more information on setting properties in this XML configuration file, please see the [JCache Declarative Configuration section](#).

Hazelcast implements a delegating `CachingProvider` that can automatically be configured for either client or member mode and that delegates to the real underlying implementation based on the user's choice. Hazelcast recommends that you use this `CachingProvider` implementation.

The delegating `CachingProvider`'s` fully qualified class name is

```
com.hazelcast.cache.HazelcastCachingProvider
```

To configure the delegating provider at the command line, add the following parameter to the Java startup call, depending on the chosen provider:

```
-Dhazelcast.jcache.provider.type=[client|server]
```

By default, the delegating `CachingProvider` is automatically picked up by the JCache SPI and provided as shown above. In cases where multiple `javax.cache.spi.CachingProvider` implementations reside on the classpath (like in some Application Server scenarios), you can select a `CachingProvider` by explicitly calling `Caching.getCachingProvider()` overloads and providing them using the canonical class name of the provider to be used. The class names of member and client providers provided by Hazelcast are mentioned in the following two subsections.



Hazelcast advises that you use the `Caching.getCachingProvider()` overloads to select a `CachingProvider` explicitly. This ensures that upgrading to later environments or Application Server versions doesn't result in unexpected behavior like choosing a wrong `CachingProvider`.

### 13.3.2. Configuring JCache with Client Provider

For cluster topologies where Hazelcast light clients are used to connect to a remote Hazelcast cluster, use the Client Provider to configure JCache.

The Client Provider provides the same features as the Server Provider. However, it does not hold data on its own but instead delegates requests and calls to the remotely connected cluster.

The Client Provider can connect to multiple clusters at the same time. This can be achieved by scoping the client side `CacheManager` with different Hazelcast configuration files. For more information, please see [Scoping to Join Clusters](#).

To request this `CachingProvider` using `Caching.getCachingProvider( String )` or `Caching.getCachingProvider( String, ClassLoader )`, use the following fully qualified class name:

```
com.hazelcast.client.cache.impl.HazelcastClientCachingProvider
```

### 13.3.3. Configuring JCache with Server Provider

If a Hazelcast member is embedded into an application directly and the Hazelcast client is not used, the Server Provider is required. In this case, the member itself becomes a part of the distributed cache and requests and operations are distributed directly across the cluster by its given key.

The Server Provider provides the same features as the Client provider, but it keeps data in the local Hazelcast member and also distributes non-owned keys to other direct cluster members.

Like the Client Provider, the Server Provider can connect to multiple clusters at the same time. This can be achieved by scoping the client side `CacheManager` with different Hazelcast configuration files. For more information please see [Scoping to Join Clusters](#).

To request this `CachingProvider` using `Caching.getCachingProvider( String )` or `Caching.getCachingProvider( String, ClassLoader )`, use the following fully qualified class name:



## 13.4. JCache API

This section explains the JCache API by providing simple examples and use cases. While walking through the examples, we will have a look at a couple of the standard API classes and see how these classes are used.

### 13.4.1. JCache API Application Example

The code in this subsection creates a small account application by providing a caching layer over an imagined database abstraction. The database layer will be simulated using single demo data in a simple DAO interface. To show the difference between the "database" access and retrieving values from the cache, a small waiting time is used in the DAO implementation to simulate network and database latency.

#### Creating User Class Example

Before we implement the JCache caching layer, let's have a quick look at some basic classes we need for this example.

The `User` class is the representation of a user table in the database. To keep it simple, it has just two properties: `userId` and `username`.

```
public class User implements Serializable {  
  
    private int userId;  
    private String username;  
  
    public User() {  
    }  
}
```

#### Creating DAO Interface Example

The DAO interface is also kept easy in this example. It provides a simple method to retrieve (find) a user by its `userId`.

```
public interface UserDao {  
  
    User findUserById(int userId);  
    boolean storeUser(int userId, User user);  
    boolean removeUser(int userId);  
    Collection<Integer> allUserIds();  
}
```

## Configuring JCache Example

To show most of the standard features, the configuration example is a little more complex.

```
// Create javax.cache.configuration.CompleteConfiguration subclass
CompleteConfiguration<Integer, User> config =
    new MutableConfiguration<Integer, User>()
        // Configure the cache to be typesafe
        .setTypes( Integer.class, User.class )
        // Configure to expire entries 30 secs after creation in the cache
        .setExpiryPolicyFactory( FactoryBuilder.factoryOf(
            new AccessedExpiryPolicy( new Duration( TimeUnit.SECONDS, 30 ) )
        ) )
        // Configure read-through of the underlying store
        .setReadThrough( true )
        // Configure write-through to the underlying store
        .setWriteThrough( true )
        // Configure the javax.cache.integration.CacheLoader
        .setCacheLoaderFactory( FactoryBuilder.factoryOf(
            new UserCacheLoader( userDao )
        ) )
        // Configure the javax.cache.integration.CacheWriter
        .setCacheWriterFactory( FactoryBuilder.factoryOf(
            new UserCacheWriter( userDao )
        ) )
        // Configure the javax.cache.event.CacheEntryListener with no
        // javax.cache.event.CacheEntryEventFilter, to include old value
        // and to be executed synchronously
        .addCacheEntryListenerConfiguration(
            new MutableCacheEntryListenerConfiguration<Integer, User>(
                new UserCacheEntryListenerFactory(),
                null, true, true
            )
        );
```

Let's go through this configuration line by line.

### Setting the Cache Type and Expire Policy

First, we set the expected types for the cache, which is already known from the previous example. On the next line, a `javax.cache.expiry.ExpiryPolicy` is configured. Almost all integration `ExpiryPolicy` implementations are configured using `javax.cache.configuration.Factory` instances. `Factory` and `FactoryBuilder` are explained later in this chapter.

### Configuring Read-Through and Write-Through

The next two lines configure the thread that will be read-through and write-through to the underlying backend resource that is configured over the next few lines. The JCache API offers `javax.cache.integration.CacheLoader` and `javax.cache.integration.CacheWriter` to implement adapter classes to any kind of backend resource, e.g., JPA, JDBC, or any other backend technology

implementable in Java. The interface provides the typical CRUD operations like `create`, `get`, `update`, `delete` and some bulk operation versions of those common operations. We will look into the implementation of those implementations later.

### Configuring Entry Listeners

The last configuration setting defines entry listeners based on sub-interfaces of `javax.cache.event.CacheEntryListener`. This config does not use a `javax.cache.event.CacheEntryEventFilter` since the listener is meant to be fired on every change that happens on the cache. Again we will look in the implementation of the listener in later in this chapter.

### Full Example Code

A full running example that is presented in this subsection is available in the [code samples repository](#). The application is built to be a command line app. It offers a small shell to accept different commands. After startup, you can enter `help` to see all available commands and their descriptions.

## 13.4.2. JCache Base Classes

In the [Example JCache Application section](#), we have already seen a couple of the base classes and explained how those work. The following are quick descriptions of them:

### `javax.cache.Caching`:

The access point into the JCache API. It retrieves the general `CachingProvider` backed by any compliant JCache implementation, such as Hazelcast JCache.

### `javax.cache.spi.CachingProvider`:

The SPI that is implemented to bridge between the JCache API and the implementation itself. Hazelcast members and clients use different providers chosen as seen in the [Configuring JCache Provider section](#) which enable the JCache API to interact with Hazelcast clusters.

When a `javax.cache.spi.CachingProvider.getCacheManager()` overload is used that takes a `java.lang.ClassLoader` argument, this classloader will be part of the scope of the created `java.cache.Cache` and it is not possible to retrieve it on other members. We advise not to use those overloads, as they are not meant to be used in distributed environments!

### `javax.cache.CacheManager`:

The `CacheManager` provides the capability to create new and manage existing JCache caches.



A `javax.cache.Cache` instance created with key and value types in the configuration provides a type checking of those types at retrieval of the cache. For that reason, all non-types retrieval methods like `getCache` throw an exception because types cannot be checked.

### `javax.cache.configuration.Configuration`, `javax.cache.configuration.MutableConfiguration`:

These two classes are used to configure a cache prior to retrieving it from a `CacheManager`. The `Configuration` interface, therefore, acts as a common super type for all compatible configuration classes such as `MutableConfiguration`.

Hazelcast itself offers a special implementation (`com.hazelcast.config.CacheConfig`) of the `Configuration` interface which offers more options on the specific Hazelcast properties that can be set to configure features like synchronous and asynchronous backups counts or selecting the underlying `in-memory format` of the cache. For more information on this configuration class, please see the reference in [JCache Programmatic Configuration section](#).

#### `javax.cache.Cache`:

This interface represents the cache instance itself. It is comparable to `java.util.Map` but offers special operations dedicated to the caching use case. Therefore, for example `javax.cache.Cache.put()`, unlike `java.util.Map.put()`, does not return the old value previously assigned to the given key.



Bulk operations on the `Cache` interface guarantee atomicity per entry but not over all given keys in the same bulk operations since no transactional behavior is applied over the whole batch process.

### 13.4.3. Implementing Factory and FactoryBuilder

The `javax.cache.configuration.Factory` implementations configure features like `CacheEntryListener`, `ExpiryPolicy` and `CacheLoader`'s or `CacheWriter`'s. These factory implementations are required to distribute the different features to members in a cluster environment like Hazelcast. Therefore, these factory implementations have to be serializable.

`Factory` implementations are easy to do, as they follow the default Provider- or Factory-Pattern. The sample class `UserCacheEntryListenerFactory` shown below implements a custom JCache `Factory`.

```
public class UserCacheEntryListenerFactory implements Factory<CacheEntryListener
<Integer, User>> {

    @Override
    public CacheEntryListener<Integer, User> create() {
        // just create a new listener instance
        return new UserCacheEntryListener();
    }
}
```

To simplify the process for the users, JCache API offers a set of helper methods collected in `javax.cache.configuration.FactoryBuilder`. In the above configuration example, `FactoryBuilder.factoryOf()` creates a singleton factory for the given instance.

### 13.4.4. Implementing CacheLoader

`javax.cache.integration.CacheLoader` loads cache entries from any external backend resource.

## Cache read-through

If the cache is configured to be `read-through`, then `CacheLoader.load()` is called transparently from the cache when the key or the value is not yet found in the cache. If no value is found for a given key, it returns null.

If the cache is not configured to be `read-through`, nothing is loaded automatically. The user code must call `javax.cache.Cache.loadAll()` to load data for the given set of keys into the cache.

For the bulk load operation (`loadAll()`), some keys may not be found in the returned result set. In this case, a `javax.cache.integration.CompletionListener` parameter can be used as an asynchronous callback after all the key-value pairs are loaded because loading many key-value pairs can take lots of time.

## CacheLoader Example

Let's look at the `UserCacheLoader` implementation. This implementation is quite straight forward.

- It implements `CacheLoader`.
- It overrides the `load` method to compute or retrieve the value corresponding to `key`.
- It overrides the `loadAll` method to compute or retrieve the values corresponding to `keys`.

An important note is that any kind of exception has to be wrapped into `javax.cache.integration.CacheLoaderException`.

```

public class UserCacheLoader implements CacheLoader<Integer, User>, Serializable {

    private final UserDao userDao;

    public UserCacheLoader(UserDao userDao) {
        // store the dao instance created externally
        this.userDao = userDao;
    }

    @Override
    public User load(Integer key) throws CacheLoaderException {
        // just call through into the dao
        return userDao.findUserById(key);
    }

    @Override
    public Map<Integer, User> loadAll(Iterable<? extends Integer> keys) throws
CacheLoaderException {
        // create the resulting map
        Map<Integer, User> loaded = new HashMap<Integer, User>();
        // for every key in the given set of keys
        for (Integer key : keys) {
            // try to retrieve the user
            User user = userDao.findUserById(key);
            // if user is not found do not add the key to the result set
            if (user != null) {
                loaded.put(key, user);
            }
        }
        return loaded;
    }
}

```

### 13.4.5. CacheWriter

You use a `javax.cache.integration.CacheWriter` to update an external backend resource. If the cache is configured to be `write-through`, this process is executed transparently to the user's code. Otherwise, there is currently no way to trigger writing changed entries to the external resource to a user-defined point in time.

If bulk operations throw an exception, `java.util.Collection` has to be cleaned of all successfully written keys so the cache implementation can determine what keys are written and can be applied to the cache state.

The following example performs the following tasks:

- It implements `CacheWriter`.
- It overrides the `write` method to write the specified entry to the underlying store.

- It overrides the `writeAll` method to write the specified entries to the underlying store.
- It overrides the `delete` method to delete the key entry from the store.
- It overrides the `deleteAll` method to delete the data and keys from the underlying store for the given collection of keys, if present.

```
public class UserCacheWriter implements CacheWriter<Integer, User>, Serializable {

    private final UserDao userDao;

    public UserCacheWriter(UserDao userDao) {
        // store the dao instance created externally
        this.userDao = userDao;
    }

    @Override
    public void write(Cache.Entry<? extends Integer, ? extends User> entry) throws
CacheWriterException {
        // store the user using the dao
        userDao.storeUser(entry.getKey(), entry.getValue());
    }

    @Override
    public void writeAll(Collection<Cache.Entry<? extends Integer, ? extends User>>
entries) throws CacheWriterException {
        // retrieve the iterator to clean up the collection from written keys in case
of an exception
        Iterator<Cache.Entry<? extends Integer, ? extends User>> iterator = entries
.iterator();
        while (iterator.hasNext()) {
            // write entry using dao
            write(iterator.next());
            // remove from collection of keys
            iterator.remove();
        }
    }

    @Override
    public void delete(Object key) throws CacheWriterException {
        // test for key type
        if (!(key instanceof Integer)) {
            throw new CacheWriterException("Illegal key type");
        }
        // remove user using dao
        userDao.removeUser((Integer) key);
    }

    @Override
    public void deleteAll(Collection<?> keys) throws CacheWriterException {
        // retrieve the iterator to clean up the collection from written keys in case
```

of an exception

```
Iterator<?> iterator = keys.iterator();
while (iterator.hasNext()) {
    // write entry using dao
    delete(iterator.next());
    // remove from collection of keys
    iterator.remove();
}
}
```

Again, the implementation is pretty straightforward and also as above all exceptions thrown by the external resource, like `java.sql.SQLException` has to be wrapped into a `javax.cache.integration.CacheWriterException`. Note this is a different exception from the one thrown by `CacheLoader`.

### 13.4.6. Implementing EntryProcessor

With `javax.cache.processor.EntryProcessor`, you can apply an atomic function to a cache entry. In a distributed environment like Hazelcast, you can move the mutating function to the member that owns the key. If the value object is big, it might prevent traffic by sending the object to the mutator and sending it back to the owner to update it.

By default, Hazelcast JCache sends the complete changed value to the backup partition. Again, this can cause a lot of traffic if the object is big. The Hazelcast ICache extension can also prevent this. Further information is available at [Implementing BackupAwareEntryProcessor](#).

An arbitrary number of arguments can be passed to the `Cache.invoke()` and `Cache.invokeAll()` methods. All of those arguments need to be fully serializable because in a distributed environment like Hazelcast, it is very likely that these arguments have to be passed around the cluster.

The following example performs the following tasks.

- It implements `EntryProcessor`.
- It overrides the `process` method to process an entry.



```

public class UserUpdateEntryProcessor implements EntryProcessor<Integer, User, User> {

    @Override
    public User process(MutableEntry<Integer, User> entry, Object... arguments) throws
    EntryProcessorException {
        // test arguments length
        if (arguments.length < 1) {
            throw new EntryProcessorException("One argument needed: username");
        }

        // get first argument and test for String type
        Object argument = arguments[0];
        if (!(argument instanceof String)) {
            throw new EntryProcessorException("First argument has wrong type, required
            java.lang.String");
        }

        // retrieve the value from the MutableEntry
        User user = entry.getValue();

        // retrieve the new username from the first argument
        String newUsername = (String) arguments[0];

        // set the new username
        user.setUsername(newUsername);

        // set the changed user to mark the entry as dirty
        entry.setValue(user);

        // return the changed user to return it to the caller
        return user;
    }
}

```



By executing the bulk `Cache.invokeAll()` operation, atomicity is only guaranteed for a single cache entry. No transactional rules are applied to the bulk operation.



JCache `EntryProcessor` implementations are not allowed to call `javax.cache.Cache` methods. This prevents operations from deadlocking between different calls.

In addition, when using a `Cache.invokeAll()` method, a `java.util.Map` is returned that maps the key to its `javax.cache.processor.EntryProcessorResult`, which itself wraps the actual result or a thrown `javax.cache.processor.EntryProcessorException`.

### 13.4.7. CacheEntryListener

The `javax.cache.event.CacheEntryListener` implementation is straight forward. `CacheEntryListener` is a super-interface that is used as a marker for listener classes in JCache. The specification brings a

set of sub-interfaces.

- `CacheEntryCreatedListener`: Fires after a cache entry is added (even on read-through by a `CacheLoader`) to the cache.
- `CacheEntryUpdatedListener`: Fires after an already existing cache entry updates.
- `CacheEntryRemovedListener`: Fires after a cache entry was removed (not expired) from the cache.
- `CacheEntryExpiredListener`: Fires after a cache entry has been expired. Expiry does not have to be a parallel process-- Hazelcast JCache implementation detects and removes expired entries periodically. Therefore, the expiration event may not be fired as soon as the entry expires. See [ExpiryPolicy](#) for details.

To configure `CacheEntryListener`, add a `javax.cache.configuration.CacheEntryListenerConfiguration` instance to the JCache configuration class, as seen in the above example configuration. In addition, listeners can be configured to be executed synchronously (blocking the calling thread) or asynchronously (fully running in parallel).

In this example application, the listener is implemented to print event information on the console. That visualizes what is going on in the cache. This application performs the following tasks:

- It implements the `CacheEntryCreatedListener.onCreated` method to call after an entry is created.
- It implements the `CacheEntryUpdatedListener.onUpdated` method to call after an entry is updated.
- It implements the `CacheEntryRemovedListener.onRemoved` method to call after an entry is removed.
- It implements the `CacheEntryExpiredListener.onExpired` method to call after an entry expires.
- It implements `printEvents` to print event information on the console.

```

class UserCacheEntryListener implements CacheEntryCreatedListener<Integer, User>,
    CacheEntryUpdatedListener<Integer, User>,
    CacheEntryRemovedListener<Integer, User>,
    CacheEntryExpiredListener<Integer, User> {

    @Override
    public void onCreated(Iterable<CacheEntryEvent<? extends Integer, ? extends User>>
cacheEntryEvents)
        throws CacheEntryListenerException {

        printEvents(cacheEntryEvents);
    }

    @Override
    public void onUpdated(Iterable<CacheEntryEvent<? extends Integer, ? extends User>>
cacheEntryEvents)
        throws CacheEntryListenerException {

        printEvents(cacheEntryEvents);
    }

    @Override
    public void onRemoved(Iterable<CacheEntryEvent<? extends Integer, ? extends User>>
cacheEntryEvents)
        throws CacheEntryListenerException {

        printEvents(cacheEntryEvents);
    }

    @Override
    public void onExpired(Iterable<CacheEntryEvent<? extends Integer, ? extends User>>
cacheEntryEvents)
        throws CacheEntryListenerException {

        printEvents(cacheEntryEvents);
    }

    private void printEvents(Iterable<CacheEntryEvent<? extends Integer, ? extends
User>> cacheEntryEvents) {
        for (CacheEntryEvent<? extends Integer, ? extends User> event :
cacheEntryEvents) {
            System.out.println(event.getEventType());
        }
    }
}

```

### 13.4.8. ExpiryPolicy

In JCache, `javax.cache.expiry.ExpiryPolicy` implementations are used to automatically expire cache

entries based on different rules.

JCache does not require expired entries to be removed from the cache immediately. It only enforces that expired entries are not returned from cache. Therefore, exact time of removal is implementation specific. Hazelcast complies JCache by checking the entries for expiration at the time of get operations (lazy expiration). In addition to that, Hazelcast uses a periodic task to detect and remove expired entries as soon as possible (eager expiration). Thanks to eager expiry, all expired entries are removed from the memory eventually even when they are not touched again. So the space used by such entries are released as well.

For a detailed explanation of interaction between expiry policies and JCache API, please refer to the table in [Expiry Policies](#) section of [JCache documentation](#).

Expiry timeouts are defined using `javax.cache.expiry.Duration`, which is a pair of `java.util.concurrent.TimeUnit`, that describes a time unit and a long, defining the timeout value. The minimum allowed `TimeUnit` is `TimeUnit.MILLISECONDS`. The long value `durationAmount` must be equal or greater than zero. A value of zero (or `Duration.ZERO`) indicates that the cache entry expires immediately.

By default, JCache delivers a set of predefined expiry strategies in the standard API.

- **AccessedExpiryPolicy**: Expires after a given set of time measured from creation of the cache entry. The expiry timeout is updated on accessing the key.
- **CreatedExpiryPolicy**: Expires after a given set of time measured from creation of the cache entry. The expiry timeout is never updated.
- **EternalExpiryPolicy**: Never expires. This is the default behavior, similar to **ExpiryPolicy** being set to null.
- **ModifiedExpiryPolicy**: Expires after a given set of time measured from creation of the cache entry. The expiry timeout is updated on updating the key.
- **TouchedExpiryPolicy**: Expires after a given set of time measured from creation of the cache entry. The expiry timeout is updated on accessing or updating the key.

Because **EternalExpiryPolicy** does not expire cache entries, it is still possible to evict values from memory if an underlying **CacheLoader** is defined.

## 13.5. JCache - Hazelcast Instance Integration

You can retrieve `javax.cache.Cache` instances using the interface **ICacheManager** of **HazelcastInstance**. This interface has the method `getCache(String name)` where `name` is the prefixed cache name. The prefixes in the cache name are URI and classloader prefixes, which are optional.

If you create a cache through a **ICacheManager** which has its own specified URI scope (and/or specified classloader), it must be prepended to the pure cache name as a prefix while retrieving the cache through `getCache(String name)`. Prefix generation for full cache name is exposed through `com.hazelcast.cache.CacheUtil.getPrefixedCacheName(String name, java.net.URI uri, ClassLoader classloader)`. If the URI scope and classloader is not specified, the pure cache name can be used directly while retrieving cache over **ICacheManager**.

If you have a cache which is not created, but is defined/exists (cache is specified in Hazelcast configuration but not created yet), you can retrieve this cache by its name. This also triggers cache creation before retrieving it. This retrieval is supported through `HazelcastInstance`. However, `HazelcastInstance` **does not** support creating a cache by specifying configuration; this is supported by Hazelcast's `ICacheManager` as it is.



If a valid (rather than **1.0.0-PFD** or **0.x** versions) JCache library does not exist on the classpath, `IllegalStateException` is thrown.

### 13.5.1. JCache and Hazelcast Instance Awareness

`HazelcastInstance` is injected into the following cache API interfaces (provided by `javax.cache.Cache` and `com.hazelcast.cache.ICache`) if they implement `HazelcastInstanceAware` interface:

- `ExpiryPolicyFactory` and `ExpiryPolicy` [provided by `javax.cache.Cache`]
- `CacheLoaderFactory` and `CacheLoader` [provided by `javax.cache.Cache`]
- `CacheWriteFactory` and `CacheWriter` [provided by `javax.cache.Cache`]
- `EntryProcessor` [provided by `javax.cache.Cache`]
- `CacheEntryListener` (`CacheEntryCreatedListener`, `CacheEntryUpdatedListener`, `CacheEntryRemovedListener`, `CacheEntryExpiredListener`) [provided by `javax.cache.Cache`]
- `CacheEntryEventFilter` [provided by `javax.cache.Cache`]
- `CompletionListener` [provided by `javax.cache.Cache`]
- `CachePartitionLostListener` [provided by `com.hazelcast.cache.ICache`]

## 13.6. Hazelcast JCache Extension - ICache

Hazelcast provides extension methods to Cache API through the interface `com.hazelcast.cache.ICache`.

It has two sets of extensions:

- Asynchronous version of all cache operations. See [Async Operations](#).
- Cache operations with custom `ExpiryPolicy` parameter to apply on that specific operation. See [Custom ExpiryPolicy](#).



`ICache` data structure can also be used by [Hazelcast Jet](#) for Real-Time Stream Processing (by enabling the Event Journal on your cache) and Fast Batch Processing. Hazelcast Jet uses `ICache` as a source (reads data from `ICache`) and as a sink (writes data to `ICache`). Please see the [Fast Batch Processing](#) and [Real-Time Stream Processing](#) use cases for Hazelcast Jet. Please also see [here](#) in the Hazelcast Jet Reference Manual to learn how Jet uses `ICache`, i.e., how it can read from and write to `ICache`.

## 13.6.1. Scoping to Join Clusters

A `CacheManager`, started either as a client or as an embedded member, can be configured to start a new Hazelcast instance or reuse an already existing one to connect to a Hazelcast cluster. To achieve this, request a `CacheManager` by passing a `java.net.URI` instance to `CachingProvider.getCacheManager()`. The `java.net.URI` instance must point to either a Hazelcast configuration or to the name of a named `com.hazelcast.core.HazelcastInstance` instance. In addition to the above, the same can be achieved by passing Hazelcast-specific properties to `CachingProvider.getCacheManager(URI, ClassLoader, Properties)` as detailed in the sections that follow.



Multiple requests for the same `java.net.URI` result in returning a `CacheManager` instance that shares the same `HazelcastInstance` as the `CacheManager` returned by the previous call.

### Examples

The following examples illustrate how `HazelcastInstances` are created or reused during the creation of a new `CacheManager`. Complete reference on the `HazelcastInstance` lookup mechanism is provided in the sections that follow.

#### Starting the Default `CacheManager`

Assuming no other `HazelcastInstance` exists in the same JVM, the `cacheManager` below will start a new `HazelcastInstance`, configured according to the configuration lookup rules as defined for `Hazelcast.newHazelcastInstance()` in case of an embedded member or `HazelcastClient.newHazelcastClient()` for a client-side `CacheManager`.

```
CachingProvider caching = Caching.getCachingProvider();
CacheManager cacheManager = caching.getCacheManager();
```

#### Reusing Existing `HazelcastInstance` with the Default `CacheManager`

When using both Hazelcast-specific features and JCache, a `HazelcastInstance` might be already available to your JCache configuration. By configuring an instance name in `hazelcast.xml` in the classpath root, the `CacheManager` will locate the existing instance by name and reuse it.

- `hazelcast.xml`:

```
<?xml version="1.0" encoding="UTF-8"?>
<hazelcast xsi:schemaLocation="http://www.hazelcast.com/schema/config hazelcast-
config-3.9.xsd" xmlns="http://www.hazelcast.com/schema/config" xmlns:xsi=
"http://www.w3.org/2001/XMLSchema-instance">
  <instance-name>hz-member-1</instance-name>
</hazelcast>
```

- `HazelcastInstance` & `CacheManager` startup:

```
// start hazelcast, configured with default hazelcast.xml
HazelcastInstance hz = Hazelcast.newHazelcastInstance();
// start the default CacheManager -- it will locate the default hazelcast.xml
configuration
// and identify the existing HazelcastInstance by its name
CachingProvider caching = Caching.getCachingProvider();
CacheManager cacheManager = caching.getCacheManager();
```

### Starting a `CacheManager` with a New `HazelcastInstance` Configured with a Non-default Configuration File

Given a configuration file named `hazelcast-jcache.xml` in the package `com.domain`, a `CacheManager` can be configured to start a new `HazelcastInstance`:

- By passing the `URI` to the configuration file as the `CacheManager's` `URI`:

```
CachingProvider caching = Caching.getCachingProvider();
CacheManager cacheManager = caching.getCacheManager(new URI(
    "classpath:com/domain/hazelcast-jcache.xml"), null);
```

- By specifying the configuration file location as a property:

```
Properties properties = HazelcastCachingProvider.propertiesByLocation(
    "classpath:com/domain/aaa-hazelcast.xml");
CachingProvider caching = Caching.getCachingProvider();
CacheManager cacheManager = caching.getCacheManager(new URI("any-uri-will-do"),
    null, properties);
```

Note that if the Hazelcast configuration file does specify an instance name, then any `CacheManagers` referencing the same configuration file will locate by name and reuse the same `HazelcastInstance`.

### Reusing an Existing Named `HazelcastInstance`

Assuming a `HazelcastInstance` named `hc-instance` is already started, it can be used as the `HazelcastInstance` to back a `CacheManager`:

- By using the instance's name as the `CacheManager's` `URI`:

```
CachingProvider caching = Caching.getCachingProvider();
CacheManager cacheManager = caching.getCacheManager(new URI("hc-instance"), null);
```

- By specifying the instance name as a property:

```
Properties properties = HazelcastCachingProvider.propertiesByInstanceName("hc-  
instance");  
CachingProvider caching = Caching.getCachingProvider();  
CacheManager cacheManager = caching.getCacheManager(new URI("any-uri-will-do"),  
null, properties);
```

## Applying Configuration Scope

To connect or join different clusters, apply a configuration scope to the `CacheManager`. If the same `URI` is used to request a `CacheManager` that was created previously, those `CacheManagers` share the same underlying `HazelcastInstance`.

To apply configuration scope you can do either one of the following:

- pass the path to the configuration file using the location property `HazelcastCachingProvider#HAZELCAST_CONFIG_LOCATION` (which resolves to `hazelcast.config.location`) as a mapping inside a `java.util.Properties` instance to the `CachingProvider.getCacheManager(uri, classLoader, properties)` call.
- use directly the configuration path as the `CacheManager`'s `URI`.

If both `HazelcastCachingProvider#HAZELCAST_CONFIG_LOCATION` property is set and the `CacheManager URI` resolves to a valid config file location, then the property value will be used to obtain the configuration for the `HazelcastInstance` the first time a `CacheManager` is created for the given `URI`.

Here is an example of using configuration scope:

```
CachingProvider cachingProvider = Caching.getCachingProvider();  
  
// Create Properties instance pointing to a Hazelcast config file  
Properties properties = new Properties();  
// "scope-hazelcast.xml" resides in package com.domain.config  
properties.setProperty( HazelcastCachingProvider.HAZELCAST_CONFIG_LOCATION,  
    "classpath:com/domain/config/scoped-hazelcast.xml" );  
  
URI cacheManagerName = new URI( "my-cache-manager" );  
CacheManager cacheManager = cachingProvider  
    .getCacheManager( cacheManagerName, null, properties );
```

Here is an example using `HazelcastCachingProvider.propertiesByLocation()` helper method:



```

CachingProvider cachingProvider = Caching.getCachingProvider();

// Create Properties instance pointing to a Hazelcast config file in root package
String configFile = "classpath:scoped-hazelcast.xml";
Properties properties = HazelcastCachingProvider
    .propertiesByLocation( configFile );

URI cacheManagerName = new URI( "my-cache-manager" );
CacheManager cacheManager = cachingProvider
    .getCacheManager( cacheManagerName, null, properties );

```

The retrieved `CacheManager` is scoped to use the `HazelcastInstance` that was just created and configured using the given XML configuration file.

Available protocols for config file URL include `classpath` to point to a classpath location, `file` to point to a filesystem location and `http` and `https` for remote web locations. In addition, everything that does not specify a protocol is recognized as a placeholder that can be configured using a system property.

```

String configFile = "my-placeholder";
Properties properties = HazelcastCachingProvider
    .propertiesByLocation( configFile );

```

You can set this on the command line:

```
-Dmy-placeholder=classpath:my-configs/scoped-hazelcast.xml
```

You should consider the following rules about the Hazelcast instance name when you specify the configuration file location using `HazelcastCachingProvider#HAZELCAST_CONFIG_LOCATION` (which resolves to `hazelcast.config.location`):

- If you also specified the `HazelcastCachingProvider#HAZELCAST_INSTANCE_NAME` (which resolves to `hazelcast.instance.name`) property, this property is used as the instance name even though you configured the instance name in the configuration file.
- If you do not specify `HazelcastCachingProvider#HAZELCAST_INSTANCE_NAME` but you configure the instance name in the configuration file using the element `<instance-name>`, this element's value will be used as the instance name.
- If you do not specify an instance name via property or in the configuration file, the URL of the configuration file location is used as the instance name.



No check is performed to prevent creating multiple `CacheManagers` with the same cluster configuration on different configuration files. If the same cluster is referred from different configuration files, multiple cluster members or clients are created.



The configuration file location will not be a part of the resulting identity of the `CacheManager`. An attempt to create a `CacheManager` with a different set of properties but an already used name will result in undefined behavior.

## Binding to a Named Instance

You can bind `CacheManager` to an existing and named `HazelcastInstance` instance. If the `instanceName` is specified in `com.hazelcast.config.Config`, it can be used directly by passing it to `CachingProvider` implementation. Otherwise (`instanceName` not set or instance is a client instance) you must get the instance name from the `HazelcastInstance` instance via the `String getName()` method to pass the `CachingProvider` implementation. Please note that `instanceName` is not configurable for the client side `HazelcastInstance` instance and is auto-generated by using group name (if it is specified). In general, `String getName()` method over `HazelcastInstance` is safer and the preferable way to get the name of the instance. Multiple `CacheManagers` created using an equal `java.net.URI` will share the same `HazelcastInstance`.

A named scope is applied nearly the same way as the configuration scope. Pass the instance name using:

- either the property `HazelcastCachingProvider#HAZELCAST_INSTANCE_NAME` (which resolves to `hazelcast.instance.name`) as a mapping inside a `java.util.Properties` instance to the `CachingProvider.getCacheManager(uri, classLoader, properties)` call.
- or use the instance name when specifying the `CacheManager`'s `URI`.

If a valid instance name is provided both as property and as `URI`, then the property value takes precedence and is used to resolve the `HazelcastInstance` the first time a `CacheManager` is created for the given `URI`.

Here is an example of Named Instance Scope with specified name:

```
Config config = new Config();
config.setInstanceName( "my-named-hazelcast-instance" );
// Create a named HazelcastInstance
Hazelcast.newHazelcastInstance( config );

CachingProvider cachingProvider = Caching.getCachingProvider();

// Create Properties instance pointing to a named HazelcastInstance
Properties properties = new Properties();
properties.setProperty( HazelcastCachingProvider.HAZELCAST_INSTANCE_NAME,
    "my-named-hazelcast-instance" );

URI cacheManagerName = new URI( "my-cache-manager" );
CacheManager cacheManager = cachingProvider
    .getCacheManager( cacheManagerName, null, properties );
```

Here is an example of Named Instance Scope with specified name passed as `URI` of the `CacheManager`:

```

Config config = new Config();
config.setInstanceName( "my-named-hazelcast-instance" );
// Create a named HazelcastInstance
Hazelcast.newHazelcastInstance( config );

CachingProvider cachingProvider = Caching.getCachingProvider();
URI cacheManagerName = new URI( "my-named-hazelcast-instance" );
CacheManager cacheManager = cachingProvider
    .getCacheManager( cacheManagerName, null);

```

Here is an example of Named Instance Scope with auto-generated name:

```

Config config = new Config();
// Create a auto-generated named HazelcastInstance
HazelcastInstance instance = Hazelcast.newHazelcastInstance( config );
String instanceName = instance.getName();

CachingProvider cachingProvider = Caching.getCachingProvider();

// Create Properties instance pointing to a named HazelcastInstance
Properties properties = new Properties();
properties.setProperty( HazelcastCachingProvider.HAZELCAST_INSTANCE_NAME,
    instanceName );

URI cacheManagerName = new URI( "my-cache-manager" );
CacheManager cacheManager = cachingProvider
    .getCacheManager( cacheManagerName, null, properties );

```

Here is an example of Named Instance Scope with auto-generated name on client instance:

```

ClientConfig clientConfig = new ClientConfig();
ClientNetworkConfig networkConfig = clientConfig.getNetworkConfig();
networkConfig.addAddress("127.0.0.1", "127.0.0.2");

// Create a client side HazelcastInstance
HazelcastInstance instance = HazelcastClient.newHazelcastClient( clientConfig );
String instanceName = instance.getName();

CachingProvider cachingProvider = Caching.getCachingProvider();

// Create Properties instance pointing to a named HazelcastInstance
Properties properties = new Properties();
properties.setProperty( HazelcastCachingProvider.HAZELCAST_INSTANCE_NAME,
    instanceName );

URI cacheManagerName = new URI( "my-cache-manager" );
CacheManager cacheManager = cachingProvider
    .getCacheManager( cacheManagerName, null, properties );

```

Here is an example using `HazelcastCachingProvider.propertiesByInstanceName()` method:

```

Config config = new Config();
config.setInstanceName( "my-named-hazelcast-instance" );
// Create a named HazelcastInstance
Hazelcast.newHazelcastInstance( config );

CachingProvider cachingProvider = Caching.getCachingProvider();

// Create Properties instance pointing to a named HazelcastInstance
Properties properties = HazelcastCachingProvider
    .propertiesByInstanceName( "my-named-hazelcast-instance" );

URI cacheManagerName = new URI( "my-cache-manager" );
CacheManager cacheManager = cachingProvider
    .getCacheManager( cacheManagerName, null, properties );

```



The `instanceName` will not be a part of the resulting identity of the `CacheManager`. An attempt to create a `CacheManager` with a different set of properties but an already used name will result in undefined behavior.

### Binding to an Existing Hazelcast Instance Object

When an existing `HazelcastInstance` object is available, it can be passed to the `CacheManager` by setting the property `HazelcastCachingProvider#HAZELCAST_INSTANCE_ITSELF`:

```
// Create a member HazelcastInstance
HazelcastInstance instance = Hazelcast.newHazelcastInstance();

Properties properties = new Properties();
properties.put( HazelcastCachingProvider.HAZELCAST_INSTANCE_ITSELF,
    instance );

CachingProvider cachingProvider = Caching.getCachingProvider();
// cacheManager initialized for uri will be bound to instance
CacheManager cacheManager = cachingProvider.getCacheManager(uri, classLoader,
    properties);
```

### 13.6.2. Namespacing

The `java.net.URI`s that don't use the above-mentioned Hazelcast-specific schemes are recognized as namespacing. Those `CacheManagers` share the same underlying default `HazelcastInstance` created (or set) by the `CachingProvider`, but they cache with the same names and different namespaces on the `CacheManager` level, and therefore they won't share the same data. This is useful where multiple applications might share the same Hazelcast JCache implementation, e.g., on application or OSGi servers, but are developed by independent teams. To prevent interfering on caches using the same name, every application can use its own namespace when retrieving the `CacheManager`.

Here is an example of using namespacing.

```
CachingProvider cachingProvider = Caching.getCachingProvider();

URI nsApp1 = new URI( "application-1" );
CacheManager cacheManagerApp1 = cachingProvider.getCacheManager( nsApp1, null );

URI nsApp2 = new URI( "application-2" );
CacheManager cacheManagerApp2 = cachingProvider.getCacheManager( nsApp2, null );
```

That way both applications share the same `HazelcastInstance` instance but not the same caches.

### 13.6.3. Retrieving an ICache Instance

Besides [Scoping to Join Clusters](#) and [Namespacing](#), which are implemented using the URI feature of the specification, all other extended operations are required to retrieve the `com.hazelcast.cache.ICache` interface instance from the JCache `javax.cache.Cache` instance. For Hazelcast, both interfaces are implemented on the same object instance. It is recommended that you stay with the specification method to retrieve the `ICache` version, since `ICache` might be subject to change without notification.

To retrieve or unwrap the `ICache` instance, you can execute the following code example:

```

CachingProvider cachingProvider = Caching.getCachingProvider();
CacheManager cacheManager = cachingProvider.getCacheManager();
Cache<Object, Object> cache = cacheManager.getCache( ... );

ICache<Object, Object> unwrappedCache = cache.unwrap( ICache.class );

```

After unwrapping the `Cache` instance into an `ICache` instance, you have access to all of the following operations, e.g., [ICache Async Methods](#) and [ICache Convenience Methods](#).

### 13.6.4. ICache Configuration

As mentioned in the [JCache Declarative Configuration section](#), the Hazelcast ICache extension offers additional configuration properties over the default JCache configuration. These additional properties include internal storage format, backup counts, eviction policy and quorum reference.

The declarative configuration for ICache is a superset of the previously discussed JCache configuration:

```

<cache>
  <!-- ... default cache configuration goes here ... -->
  <backup-count>1</backup-count>
  <async-backup-count>1</async-backup-count>
  <in-memory-format>BINARY</in-memory-format>
  <eviction size="10000" max-size-policy="ENTRY_COUNT" eviction-policy="LRU" />
  <partition-lost-listeners>
    <partition-lost-listener>CachePartitionLostListenerImpl</partition-lost-listener>
  </partition-lost-listeners>
  <quorum-ref>quorum-name</quorum-ref>
  <disable-per-entry-invalidation-events>true</disable-per-entry-invalidation-events>
</cache>

```

- **backup-count**: Number of synchronous backups. Those backups are executed before the mutating cache operation is finished. The mutating operation is blocked. Its default value is 1.
- **async-backup-count**: Number of asynchronous backups. Those backups are executed asynchronously so the mutating operation is not blocked and it will be done immediately. Its default value is 0.
- **in-memory-format**: Internal storage format. For more information, please see the [in-memory format section](#). Its default value is `BINARY`.
- **eviction**: Defines the used eviction strategies and sizes for the cache. For more information on eviction, please see the [JCache Eviction](#).
  - **size**: Maximum number of records or maximum size in bytes depending on the **max-size-policy** property. Size can be any integer between 0 and `Integer.MAX_VALUE`. The default **max-size-policy** is `ENTRY_COUNT` and its default size is `10.000`.
  - **max-size-policy**: Maximum size. If maximum size is reached, the cache is evicted based on the eviction policy. Default **max-size-policy** is `ENTRY_COUNT` and its default size is `10.000`. The

following eviction policies are available:

- **ENTRY\_COUNT**: Maximum number of cache entries in the cache. **Available on heap based cache record store only.**
- **USED\_NATIVE\_MEMORY\_SIZE**: Maximum used native memory size in megabytes per cache for each Hazelcast instance. **Available on High-Density Memory cache record store only.**
- **USED\_NATIVE\_MEMORY\_PERCENTAGE**: Maximum used native memory size percentage per cache for each Hazelcast instance. **Available on High-Density Memory cache record store only.**
- **FREE\_NATIVE\_MEMORY\_SIZE**: Minimum free native memory size in megabytes for each Hazelcast instance. **Available on High-Density Memory cache record store only.**
- **FREE\_NATIVE\_MEMORY\_PERCENTAGE**: Minimum free native memory size percentage for each Hazelcast instance. **Available on High-Density Memory cache record store only.**
- **eviction-policy**: Eviction policy that compares values to find the best matching eviction candidate. Its default value is **LRU**.
  - **LRU**: Less Recently Used - finds the best eviction candidate based on the lastAccessTime.
  - **LFU**: Less Frequently Used - finds the best eviction candidate based on the number of hits.
- **partition-lost-listeners** : Defines listeners for dispatching partition lost events for the cache. For more information, please see the [ICache Partition Lost Listener section](#).
- **quorum-ref** : Name of quorum configuration that you want this cache to use.
- **disable-per-entry-invalidation-events** : Disables invalidation events for each entry; but full-flush invalidation events are still enabled. Full-flush invalidation means the invalidation of events for all entries when **clear** is called. Its default value is **false**.

Since `javax.cache.configuration.MutableConfiguration` misses the above additional configuration properties, Hazelcast ICache extension provides an extended configuration class called `com.hazelcast.config.CacheConfig`. This class is an implementation of `javax.cache.configuration.CompleteConfiguration` and all the properties shown above can be configured using its corresponding setter methods.

NOTE:At the client side, ICache can be configured only programmatically.

### 13.6.5. ICache Async Methods

As another addition of Hazelcast ICache over the normal JCache specification, Hazelcast provides asynchronous versions of almost all methods, returning a `com.hazelcast.core.ICompletableFuture`. By using these methods and the returned future objects, you can use JCache in a reactive way by registering zero or more callbacks on the future to prevent blocking the current thread.

The asynchronous versions of the methods append the phrase **Async** to the method name. The example code below uses the method `putAsync()`.

```

ICache<Integer, String> unwrappedCache = cache.unwrap( ICache.class );
CompletableFuture<String> future = unwrappedCache.getAndPutAsync( 1, "value" );
future.andThen( new ExecutionCallback<String>() {
    public void onResponse( String response ) {
        System.out.println( "Previous value: " + response );
    }

    public void onFailure( Throwable t ) {
        t.printStackTrace();
    }
} );

```

Following methods are available in asynchronous versions:

- `get(key)`:
  - `getAsync(key)`
  - `getAsync(key, expiryPolicy)`
- `put(key, value)`:
  - `putAsync(key, value)`
  - `putAsync(key, value, expiryPolicy)`
- `putIfAbsent(key, value)`:
  - `putIfAbsentAsync(key, value)`
  - `putIfAbsentAsync(key, value, expiryPolicy)`
- `getAndPut(key, value)`:
  - `getAndPutAsync(key, value)`
  - `getAndPutAsync(key, value, expiryPolicy)`
- `remove(key)`:
  - `removeAsync(key)`
- `remove(key, value)`:
  - `removeAsync(key, value)`
- `getAndRemove(key)`:
  - `getAndRemoveAsync(key)`
- `replace(key, value)`:
  - `replaceAsync(key, value)`
  - `replaceAsync(key, value, expiryPolicy)`
- `replace(key, oldValue, newValue)`:
  - `replaceAsync(key, oldValue, newValue)`
  - `replaceAsync(key, oldValue, newValue, expiryPolicy)`
- `getAndReplace(key, value)`:
  - `getAndReplaceAsync(key, value)`
  - `getAndReplaceAsync(key, value, expiryPolicy)`



The methods with a given `javax.cache.expiry.ExpiryPolicy` are further discussed in the [Defining a Custom ExpiryPolicy](#).



Asynchronous versions of the methods are not compatible with synchronous events.

### 13.6.6. Defining a Custom ExpiryPolicy

The JCache specification has an option to configure a single `ExpiryPolicy` per cache. Hazelcast ICache extension offers the possibility to define a custom `ExpiryPolicy` per key by providing a set of method overloads with an `expiryPolicy` parameter, as in the list of asynchronous methods in the [Async Methods section](#). This means that you can pass custom expiry policies to a cache operation.

Here is how an `ExpiryPolicy` is set on JCache configuration:

```
CompleteConfiguration<String, String> config =
    new MutableConfiguration<String, String>()
        .setExpiryPolicyFactory(
            AccessedExpiryPolicy.factoryOf( Duration.ONE_MINUTE )
        );
```

To pass a custom `ExpiryPolicy`, a set of overloads is provided. You can use them as shown in the following code example.

```
ICache<Integer, String> unwrappedCache = cache.unwrap( ICache.class );
unwrappedCache.put( 1, "value", new AccessedExpiryPolicy( Duration.ONE_DAY ) );
```

The `ExpiryPolicy` instance can be pre-created, cached and re-used, but only for each cache instance. This is because `ExpiryPolicy` implementations can be marked as `java.io.Closeable`. The following list shows the provided method overloads over `javax.cache.Cache` by `com.hazelcast.cache.ICache` featuring the `ExpiryPolicy` parameter:

- `get(key)`:
  - `get(key, expiryPolicy)`
- `getAll(keys)`:
  - `getAll(keys, expiryPolicy)`
- `put(key, value)`:
  - `put(key, value, expiryPolicy)`
- `getAndPut(key, value)`:
  - `getAndPut(key, value, expiryPolicy)`
- `putAll(map)`:
  - `putAll(map, expiryPolicy)`
- `putIfAbsent(key, value)`:
  - `putIfAbsent(key, value, expiryPolicy)`

- `replace(key, value)`:
  - `replace(key, value, expirePolicy)`
- `replace(key, oldValue, newValue)`:
  - `replace(key, oldValue, newValue, expirePolicy)`
- `getAndReplace(key, value)`:
  - `getAndReplace(key, value, expirePolicy)`

Asynchronous method overloads are not listed here. Please see [ICache Async Methods](#) for the list of asynchronous method overloads.

ICache also offers `setExpiryPolicy(key, expirePolicy)` method to associate certain keys with custom expiry policies. Per key expiry policies defined by this method take precedence over cache policies, but they are overridden by the expiry policies specified in above mentioned overloaded methods.

### 13.6.7. JCache Eviction

Caches are generally not expected to grow to an infinite size. Implementing an [expiry policy](#) is one way you can prevent infinite growth, but sometimes it is hard to define a meaningful expiration timeout. Therefore, Hazelcast JCache provides the eviction feature. Eviction offers the possibility of removing entries based on the cache size or amount of used memory (Hazelcast IMDG Enterprise Only) and not based on timeouts.

#### Eviction and Runtime

Since a cache is designed for high throughput and fast reads, Hazelcast put a lot of effort into designing the eviction system to be as predictable as possible. All built-in implementations provide an amortized  $O(1)$  runtime. The default operation runtime is rendered as  $O(1)$ , but it can be faster than the normal runtime cost if the algorithm finds an expired entry while sampling.

#### Cache Types

Most importantly, typical production systems have two common types of caches:

- **Reference Caches:** Caches for reference data are normally small and are used to speed up the de-referencing as a lookup table. Those caches are commonly tend to be small and contain a previously known, fixed number of elements, e.g., states of the USA or abbreviations of elements.
- **Active DataSet Caches:** The other type of caches normally caches an active data set. These caches run to their maximum size and evict the oldest or not frequently used entries to keep in memory bounds. They sit in front of a database or HTML generators to cache the latest requested data.

Hazelcast JCache eviction supports both types of caches using a slightly different approach based on the configured maximum size of the cache. For detailed information, please see the [Eviction Algorithm section](#).

## Configuring Eviction Policies

Hazelcast JCache provides two commonly known eviction policies, LRU and LFU, but loosens the rules for predictable runtime behavior. LRU, normally recognized as **Least Recently Used**, is implemented as **Less Recently Used** and LFU known as **Least Frequently Used** is implemented as **Less Frequently Used**. The details about this difference are explained in the [Eviction Algorithm section](#).

Eviction Policies are configured by providing the corresponding abbreviation to the configuration as shown in the [ICache Configuration section](#). As already mentioned, two built-in policies are available:

To configure the use of the LRU (Less Recently Used) policy:

```
<eviction size="10000" max-size-policy="ENTRY_COUNT" eviction-policy="LRU" />
```

And to configure the use of the LFU (Less Frequently Used) policy:

```
<eviction size="10000" max-size-policy="ENTRY_COUNT" eviction-policy="LFU" />
```

The default eviction policy is LRU. Therefore, Hazelcast JCache does not offer the possibility of performing no eviction.

### Custom Eviction Policies

Besides the out-of-the-box eviction policies LFU and LRU, you can also specify your custom eviction policies through the eviction configuration either programmatically or declaratively.

You can provide your `com.hazelcast.cache.CacheEvictionPolicyComparator` implementation to compare `com.hazelcast.cache.CacheEntryViews`. Supplied `CacheEvictionPolicyComparator` is used to compare cache entry views to select the one with higher priority to evict.

Here is an example for custom eviction policy comparator implementation for JCache:

```

public class MyCacheEvictionPolicyComparator
    extends CacheEvictionPolicyComparator<Long, String> {

    @Override
    public int compare(CacheEntryView<Long, String> e1, CacheEntryView<Long, String>
e2) {
        long id1 = e1.getKey();
        long id2 = e2.getKey();
        if (id1 > id2) {
            return FIRST_ENTRY_HAS_HIGHER_PRIORITY_TO_BE_EVICTED; // -1
        } else if (id1 < id2) {
            return SECOND_ENTRY_HAS_HIGHER_PRIORITY_TO_BE_EVICTED; // +1
        } else {
            return BOTH_OF_ENTRIES_HAVE_SAME_PRIORITY_TO_BE_EVICTED; // 0
        }
    }
}

```

Custom eviction policy comparator can be specified through the eviction configuration by giving the full class name of the `EvictionPolicyComparator` (`CacheEvictionPolicyComparator` for JCache and its Near Cache) implementation or by specifying its instance itself.

#### Programmatic:

You can specify the full class name of custom `EvictionPolicyComparator` (`CacheEvictionPolicyComparator` for JCache and its Near Cache) implementation through `EvictionConfig`. This approach is useful when eviction configuration is specified at the client side and custom `EvictionPolicyComparator` implementation class itself does not exist at the client but at server side.

```

CacheConfig cacheConfig = new CacheConfig();
...
EvictionConfig evictionConfig =
    new EvictionConfig(50000,
        MaxSizePolicy.ENTRY_COUNT,
        "com.mycompany.MyEvictionPolicyComparator");
cacheConfig.setEvictionConfig(evictionConfig);

```

You can specify the custom `EvictionPolicyComparator` (`CacheEvictionPolicyComparator` for JCache and its Near Cache) instance itself directly through `EvictionConfig`.

```
CacheConfig cacheConfig = new CacheConfig();
...
EvictionConfig evictionConfig =
    new EvictionConfig(50000,
        MaxSizePolicy.ENTRY_COUNT,
        new MyEvictionPolicyComparator());
cacheConfig.setEvictionConfig(evictionConfig);
```

### Declarative:

You can specify the full class name of custom `EvictionPolicyComparator` (`CacheEvictionPolicyComparator` for JCache and its Near Cache) implementation in the `<eviction>` tag through `comparator-class-name` attribute in Hazelcast configuration XML file.

```
<cache name="cacheWithCustomEvictionPolicyComparator">
    <eviction size="50000" max-size-policy="ENTRY_COUNT" comparator-class-name=
"com.mycompany.MyEvictionPolicyComparator"/>
</cache>
```

### Declarative for Spring:

You can specify the full class name of custom `EvictionPolicyComparator` (`CacheEvictionPolicyComparator` for JCache and its Near Cache) implementation in the `<eviction>` tag through `comparator-class-name` attribute in Hazelcast **Spring** configuration XML file.

```
<hz:cache name="cacheWithCustomEvictionPolicyComparator">
    <hz:eviction size="50000" max-size-policy="ENTRY_COUNT" comparator-class-name=
"com.mycompany.MyEvictionPolicyComparator"/>
</hz:cache>
```

You can specify the custom `EvictionPolicyComparator` (`CacheEvictionPolicyComparator` for JCache and its Near Cache) bean in the `<eviction>` tag by referencing through `comparator-bean` attribute in Hazelcast **Spring** configuration XML file

```
<hz:cache name="cacheWithCustomEvictionPolicyComparator">
    <hz:eviction size="50000" max-size-policy="ENTRY_COUNT" comparator-bean=
"myEvictionPolicyComparatorBean"/>
</hz:cache>
```

### Eviction Strategy

Eviction strategies implement the logic of selecting one or more eviction candidates from the underlying storage implementation and passing them to the eviction policies. Hazelcast JCache provides an amortized O(1) cost implementation for this strategy to select a fixed number of samples from the current partition that it is executed against.

The default implementation is `com.hazelcast.cache.impl.eviction.impl.strategy.sampling.SamplingBasedEvictionStrategy` which, as mentioned, samples 15 random elements. A detailed description of the algorithm will be explained in the next section.

## Eviction Algorithm

The Hazelcast JCache eviction algorithm is specially designed for the use case of high performance caches and with predictability in mind. The built-in implementations provide an amortized  $O(1)$  runtime and therefore provide a highly predictable runtime behavior which does not rely on any kind of background threads to handle the eviction. Therefore, the algorithm takes some assumptions into account to prevent network operations and concurrent accesses.

As an explanation of how the algorithm works, let's examine the following flowchart step by step.

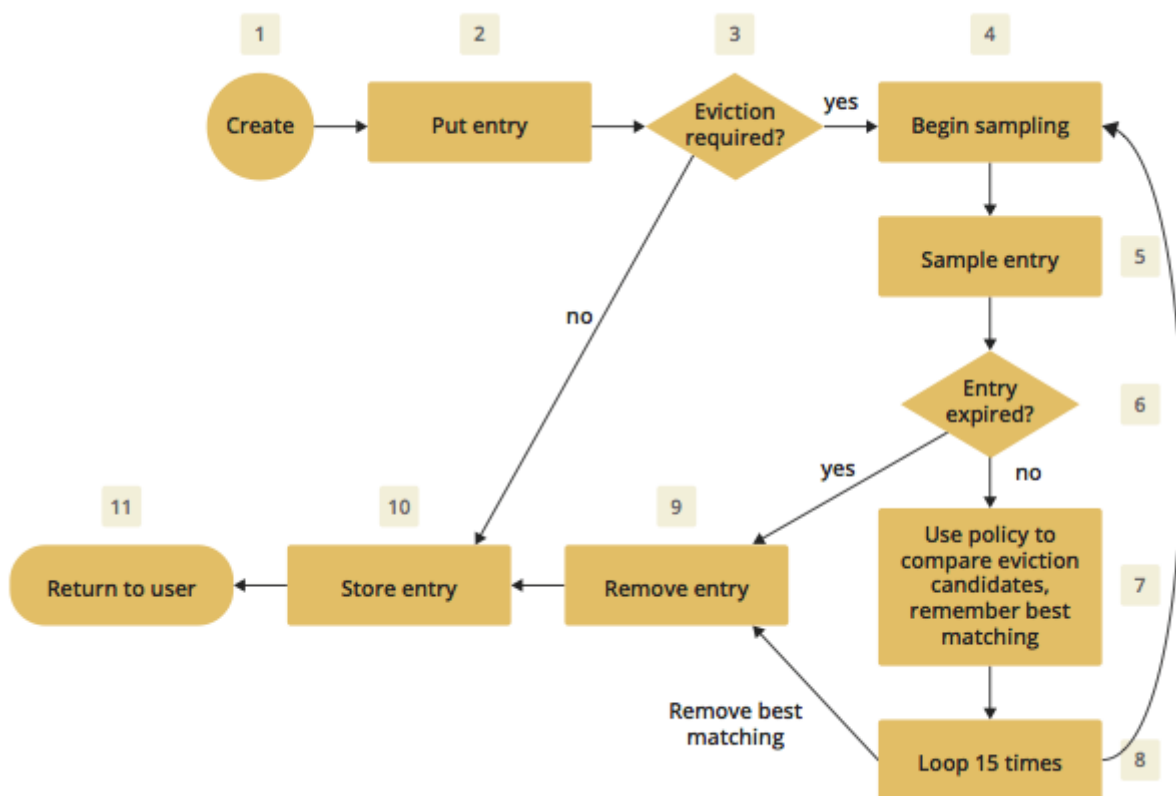

1. A new cache is created. Without any special settings, the eviction is configured to kick in when the **cache** exceeds 10.000 elements and an LRU (Less Recently Used) policy is set up.
2. The user puts in a new entry, e.g., a key-value pair.
3. For every put, the eviction strategy evaluates the current cache size and decides if an eviction is necessary or not. If not, the entry is stored in step 10.
4. If eviction is required, a new sampling is started. The built-in sampler is implemented as a lazy iterator.
5. The sampling algorithm selects a random sample from the underlying data storage.
6. The eviction strategy tests whether the sampled entry is already expired (lazy expiration). If expired, the sampling stops and the entry is removed in step 9.

7. If not yet expired, the entry (eviction candidate) is compared to the last best matching candidate (based on the eviction policy) and the new best matching candidate is remembered.
8. The sampling is repeated 15 times and then the best matching eviction candidate is returned to the eviction strategy.
9. The expired or best matching eviction candidate is removed from the underlying data storage.
10. The new put entry is stored.
11. The put operation returns to the user.



Note that expiration based eviction does not only occur for the above scenario (Step 6). It is mentioned for the sake of explaining the eviction algorithm.

As seen in the flowchart, the general eviction operation is easy. As long as the cache does not reach its maximum capacity, or you execute updates (put/replace), no eviction is executed.

To prevent network operations and concurrent access, as mentioned earlier, the cache size is estimated based on the size of the currently handled partition. Due to the imbalanced partitions, the single partitions might start to evict earlier than the other partitions.

As mentioned in the [Cache Types section](#), typically two types of caches are found in the production systems. For small caches, referred to as **Reference Caches**, the eviction algorithm has a special set of rules depending on the maximum configured cache size. Please see the [Reference Caches section](#) for details. The other type of cache is referred to as an **Active DataSet Cache**, which in most cases makes heavy use of the eviction to keep the most active data set in the memory. Those kinds of caches use a very simple but efficient way to estimate the cluster-wide cache size.

All of the following calculations have a well known set of fixed variables:

- **GlobalCapacity**: User defined maximum cache size (cluster-wide).
- **PartitionCount**: Number of partitions in the cluster (defaults to 271).
- **BalancedPartitionSize**: Number of elements in a balanced partition state,  $\text{BalancedPartitionSize} := \text{GlobalCapacity} / \text{PartitionCount}$ .
- **Deviation**: An approximated standard deviation (tests proofed it to be pretty near),  $\text{Deviation} := \text{sqrt}(\text{BalancedPartitionSize})$ .

### Reference Caches

A Reference Cache is typically small and the number of elements to store in the reference caches is normally known prior to creating the cache. Typical examples of reference caches are lookup tables for abbreviations or the states of a country. They tend to have a fixed but small element number and the eviction is an unlikely event and rather undesirable behavior.

Since an imbalanced partition is a worse problem in small and mid-sized caches than in caches with millions of entries, the normal estimation rule (as discussed in a bit) is not applied to these kinds of caches. To prevent unwanted eviction on the small and mid-sized caches, Hazelcast implements a special set of rules to estimate the cluster size.

To adjust the imbalance of partitions as found in the typical runtime, the actual calculated

maximum cache size (known as the eviction threshold) is slightly higher than the user defined size. That means more elements can be stored into the cache than expected by the user. This needs to be taken into account especially for large objects, since those can easily exceed the expected memory consumption!

### Small caches:

If a cache is configured with no more than **4.000** elements, this cache is considered to be a small cache. The actual partition size is derived from the number of elements (**GlobalCapacity**) and the deviation using the following formula:

```
MaxPartitionSize := Deviation * 5 + BalancedPartitionSize
```

This formula ends up with big partition sizes which, summed up, exceed the expected maximum cache size (set by the user). Since the small caches typically have a well known maximum number of elements, this is not a big issue. Only if the small caches are used for a use case other than as a reference cache, this needs to be taken into account.

### Mid-sized caches

A mid-sized cache is defined as a cache with a maximum number of elements that is bigger than **4.000** but not bigger than **1.000.000** elements. The calculation of mid-sized caches is similar to that of the small caches but with a different multiplier. To calculate the maximum number of elements per partition, the following formula is used:

```
MaxPartitionSize := Deviation * 3 + BalancedPartitionSize
```

### Active DataSet Caches

For large caches, where the maximum cache size is bigger than **1.000.000** elements, there is no additional calculation needed. The maximum partition size is considered to be equal to **BalancedPartitionSize** since statistically big partitions are expected to almost balance themselves. Therefore, the formula is as easy as the following:

```
MaxPartitionSize := BalancedPartitionSize
```

### Cache Size Estimation

As mentioned earlier, Hazelcast JCache provides an estimation algorithm to prevent cluster-wide network operations, concurrent access to other partitions and background tasks. It also offers a highly predictable operation runtime when the eviction is necessary.

The estimation algorithm is based on the previously calculated maximum partition size (please see the [Reference Caches section](#) and [Active DataSet Caches section](#)) and is calculated against the current partition only.

The algorithm to reckon the number of stored entries in the cache (cluster-wide) and decide if the



eviction is necessary is shown in the following pseudo-code example:

```
RequiresEviction[Boolean] := CurrentPartitionSize >= MaxPartitionSize
```

### 13.6.8. JCache Near Cache

The Hazelcast JCache implementation supports a local Near Cache for remotely stored entries to increase the performance of local read operations. Please refer to the [Near Cache section](#) for a detailed explanation of the Near Cache feature and its configuration.



Near Cache for JCache is only available for clients, NOT members.

### 13.6.9. ICache Convenience Methods

In addition to the operations explained in [ICache Async Methods](#) and [Defining a Custom ExpiryPolicy](#), Hazelcast ICache also provides a set of convenience methods. These methods are not part of the JCache specification.

- `size()`: Returns the total entry count of the distributed cache.
- `destroy()`: Destroys the cache and removes its data, which makes it different from the method `javax.cache.Cache.close()`; the `close` method closes the cache so no further operational methods (get, put, remove, etc. Please see Section 4.1.6 in JCache Specification which can be downloaded from [here](#)) can be executed on it - data is not necessarily destroyed, if you get again the same `Cache` from the same `CacheManager`, the data will be there. In the case of `destroy()`, both the cache is destroyed and cache's data is removed.
- `isDestroyed()`: Determines whether the ICache instance is destroyed or not.
- `getLocalCacheStatistics()`: Returns a `com.hazelcast.cache.CacheStatistics` instance, both on Hazelcast members and clients, providing the same statistics data as the JMX beans.

Please refer to the [ICache Javadoc](#) to see all the methods provided by ICache.

### 13.6.10. Implementing BackupAwareEntryProcessor

Another feature, especially interesting for distributed environments like Hazelcast, is the JCache specified `javax.cache.processor.EntryProcessor`. For more general information, please see the [Implementing EntryProcessor section](#).

Since Hazelcast provides backups of cached entries on other members, the default way to backup an object changed by an `EntryProcessor` is to serialize the complete object and send it to the backup partition. This can be a huge network overhead for big objects.

Hazelcast offers a sub-interface for `EntryProcessor` called `com.hazelcast.cache.BackupAwareEntryProcessor`. This allows you to create or pass another `EntryProcessor` to run on backup partitions and apply delta changes to the backup entries.

The backup partition `EntryProcessor` can either be the currently running processor (by returning `this`) or it can be a specialized `EntryProcessor` implementation (different from the currently

running one) that does different operations or leaves out operations, e.g., sending emails.

If we again take the `EntryProcessor` example from the demonstration application provided in the [Implementing EntryProcessor](#) section, the changed code will look like the following snippet.

```
public class UserUpdateEntryProcessor
    implements BackupAwareEntryProcessor<Integer, User, User> {

    @Override
    public User process( MutableEntry<Integer, User> entry, Object... arguments )
        throws EntryProcessorException {

        // Test arguments length
        if ( arguments.length < 1 ) {
            throw new EntryProcessorException( "One argument needed: username" );
        }

        // Get first argument and test for String type
        Object argument = arguments[0];
        if ( !( argument instanceof String ) ) {
            throw new EntryProcessorException(
                "First argument has wrong type, required java.lang.String" );
        }

        // Retrieve the value from the MutableEntry
        User user = entry.getValue();

        // Retrieve the new username from the first argument
        String newUsername = ( String ) arguments[0];

        // Set the new username
        user.setUsername( newUsername );

        // Set the changed user to mark the entry as dirty
        entry.setValue( user );

        // Return the changed user to return it to the caller
        return user;
    }

    public EntryProcessor<Integer, User, User> createBackupEntryProcessor() {
        return this;
    }
}
```

You can use the additional method `BackupAwareEntryProcessor.createBackupEntryProcessor()` to create or return the `EntryProcessor` implementation to run on the backup partition (in the example above, the same processor again).



For the backup runs, the returned value from the backup processor is ignored and not returned to the user.

### 13.6.11. ICache Partition Lost Listener

You can listen to `CachePartitionLostEvent` instances by registering an implementation of `CachePartitionLostListener`, which is also a sub-interface of `java.util.EventListener` from `ICache`.

Let's consider the following example code:

```
public class PartitionLostListenerUsage {

    public static void main(String[] args) {

        String cacheName1 = "myCache1";

        CachingProvider cachingProvider = Caching.getCachingProvider();
        CacheManager cacheManager = cachingProvider.getCacheManager();

        CacheConfig<Integer, String> config1 = new CacheConfig<Integer, String>();
        Cache<Integer, String> cache1 = cacheManager.createCache(cacheName1, config1);

        ICache<Object, Object> unwrappedCache = cache1.unwrap( ICache.class );

        unwrappedCache.addPartitionLostListener(new CachePartitionLostListener() {
            @Override
            public void partitionLost(CachePartitionLostEvent event) {
                System.out.println(event);
            }
        });
    }
}
```

Within this example code, a `CachePartitionLostListener` implementation is registered to a cache and assumes that this cache is configured with one backup. For this particular cache and any of the partitions in the system, if the partition owner member and its first backup member crash simultaneously, the given `CachePartitionLostListener` receives a corresponding `CachePartitionLostEvent`. If only a single member crashes in the cluster, a `CachePartitionLostEvent` is not fired for this cache since backups for the partitions owned by the crashed member are kept on other members.

Please refer to the [Partition Lost Listener section](#) for more information about partition lost detection and partition lost events.

## 13.7. Testing for JCache Specification Compliance

Hazelcast JCache is fully compliant with the JSR 107 TCK (Technology Compatibility Kit), and therefore is officially a JCache implementation.

You can test Hazelcast JCache for compliance by executing the TCK. Just perform the instructions below:

- Checkout branch `v1.1.0` of the TCK from <https://github.com/jsr107/jsr107tck>.
- Change the properties in `pom.xml` as shown below. Alternatively, you can set the values of these properties directly on the maven command line without editing any files as shown in the command line example below.
- Run the TCK using the command `mvn clean install`. This will run the tests using an embedded Hazelcast member.

```
<properties>
  <jcache.version>1.1.0</jcache.version>
  <project.build.sourceEncoding>UTF-8</project.build.sourceEncoding>
  <project.reporting.outputEncoding>UTF-8</project.reporting.outputEncoding>

  <CacheInvocationContextImpl>
    javax.cache.annotation.impl.cdi.CdiCacheKeyInvocationContextImpl
  </CacheInvocationContextImpl>

  <domain-lib-dir>${project.build.directory}/domainlib</domain-lib-dir>
  <domain-jar>domain.jar</domain-jar>

  <!-- ##### -->
  <!-- Change the following properties on the command line
        to override with the coordinates for your implementation-->
  <implementation-groupId>com.hazelcast</implementation-groupId>
  <implementation-artifactId>hazelcast</implementation-artifactId>
  <implementation-version>3.10</implementation-version>

  <!-- Change the following properties to your CacheManager and
        Cache implementation. Used by the unwrap tests. -->
  <CacheManagerImpl>
    com.hazelcast.client.cache.impl.HazelcastServerCacheManager
  </CacheManagerImpl>
  <CacheImpl>com.hazelcast.cache.ICache</CacheImpl>
  <CacheEntryImpl>
    com.hazelcast.cache.impl.CacheEntry
  </CacheEntryImpl>
  <!-- ##### -->
</properties>
```

Complete command line example:

```
$ git clone https://github.com/jsr107/jsr107tck
(clones JSR107 TCK repository to local directory jsr107tck)

$ cd jsr107tck

$ git checkout v1.1.0
(checkout v1.1.0 tag)

$ mvn -DimplementationGroupId=com.hazelcast -DimplementationArtifactId=hazelcast \
-DimplementationVersion=3.10 \
-DCacheManagerImpl=com.hazelcast.cache.impl.HazelcastServerCacheManager \
-DCacheImpl=com.hazelcast.cache.ICache
-DCacheEntryImpl=com.hazelcast.cache.impl.CacheEntry \
clean install
```

Please also see [TCK 1.1.0 User Guide](#) or [TCK 1.0.0 User Guide](#) for more information on the testing instructions.

## 14. Integrated Clustering

In this chapter, we mention how Hazelcast is integrated with Hibernate 2nd level cache and Spring and how it helps with your Filter, Tomcat and Jetty based web session replications.

### 14.1. Integration with Hibernate Second Level Cache

Hazelcast provides its own distributed second level cache for your Hibernate entities, collections and queries. This feature is offered as a Hazelcast plugin. See [Hazelcast Hibernate 2LC](#) for details.

### 14.2. Web Session Replications

Hazelcast can cluster your web sessions using Servlet Filter, Tomcat and Jetty based solutions.

Follow the below links for more information on them:

- [Filter Based Web Session Replication](#)
- [Tomcat Based Web Session Replication](#)
- [Jetty Based Web Session Replication](#)

### 14.3. Integration with Java EE

You can integrate Hazelcast into Java EE containers. This integration is offered as a Hazelcast plugin. See [Hazelcast JCA Resource Adapter section](#) and its own GitHub repository [here](#) for information on configuring the resource adapter, glassfish applications and JBoss web applications.

## 14.4. Integration with Spring

You can integrate Hazelcast with Spring and this section explains the configuration of Hazelcast within Spring context.

Supported Versions are Spring 2.5 and higher releases and the latest tested Spring version is 4.3.



Some old versions of Spring may require minor changes in the Hazelcast configuration. The code and configuration snippets provided in this section are tested using Spring 4.3.

### 14.4.1. Configuring Spring

**Sample Code:** See our [sample application](#) for Spring Configuration.

#### Enabling Spring Integration

*Classpath Configuration:*



To enable Spring integration, either `hazelcast-spring-<version>.jar` or `hazelcast-all-<version>.jar` must be in the classpath.

If you use Maven, add the following lines to your `pom.xml`.

If you use `hazelcast-all.jar`:

```
<dependency>
  <groupId>com.hazelcast</groupId>
  <artifactId>hazelcast-all</artifactId>
  <version>"your Hazelcast version, e.g. 3.8"</version>
</dependency>
```

If you use `hazelcast-spring.jar`:

```
<dependency>
  <groupId>com.hazelcast</groupId>
  <artifactId>hazelcast-spring</artifactId>
  <version>"your Hazelcast version, e.g. 3.8"</version>
</dependency>
```

If you use other build systems, you have to adjust the definition of dependencies to your needs.

#### Troubleshooting

When the Spring Integration JARs are not correctly installed in the Java classpath, you may see either of the following exceptions:

```
org.xml.sax.SAXParseException; systemId: http://hazelcast.com/schema/spring/hazelcast-spring.xsd; lineNumber: 2; columnNumber: 35; s4s-elt-character: Non-whitespace characters are not allowed in schema elements other than 'xs:appinfo' and 'xs:documentation'. Saw '301 Moved Permanently'.
```

```
org.springframework.beans.factory.parsing.BeanDefinitionParsingException: Configuration problem: Unable to locate Spring NamespaceHandler for XML schema namespace [http://www.hazelcast.com/schema/spring]
```

```
org.xml.sax.SAXParseException; lineNumber: 25; columnNumber: 33; schema_reference.4: Failed to read schema document 'http://www.hazelcast.com/schema/spring/hazelcast-spring.xsd', because 1) could not find the document; 2) the document could not be read; 3) the root element of the document is not <xsd:schema>.
```

In this case, please ensure that the required classes are in the classpath, as explained above.

## Declaring Beans by Spring beans Namespace

*Bean Declaration:*

You can declare Hazelcast Objects using the default Spring **beans** namespace. Example code for a Hazelcast Instance declaration is listed below.

```
<bean id="instance" class="com.hazelcast.core.Hazelcast" factory-method="newHazelcastInstance">
  <constructor-arg>
    <bean class="com.hazelcast.config.Config">
      <property name="groupConfig">
        <bean class="com.hazelcast.config.GroupConfig">
          <property name="name" value="dev"/>
          <property name="password" value="pwd"/>
        </bean>
      </property>
      <!-- and so on ... -->
    </bean>
  </constructor-arg>
</bean>

<bean id="map" factory-bean="instance" factory-method="getMap">
  <constructor-arg value="map"/>
</bean>
```

## Declaring Beans by hazelcast Namespace

Hazelcast has its own namespace **hazelcast** for bean definitions. You can easily add the namespace declaration `xmlns:hz="http://www.hazelcast.com/schema/spring"` to the **beans** element in the

context file so that **hz** namespace shortcut can be used as a bean declaration.

Here is an example schema definition for Hazelcast 3.3.x:

```
<beans xmlns="http://www.springframework.org/schema/beans"
  xmlns:xsi="http://www.w3.org/2001/XMLSchema-instance"
  xmlns:hz="http://www.hazelcast.com/schema/spring"
  xsi:schemaLocation="http://www.springframework.org/schema/beans
    http://www.springframework.org/schema/beans/spring-beans-3.0.xsd
    http://www.hazelcast.com/schema/spring
    http://www.hazelcast.com/schema/spring/hazelcast-spring.xsd">
```

## Supported Configurations with hazelcast Namespace

- **Configuring Hazelcast Instance**

```
<hz:hazelcast id="instance">
  <hz:config>
    <hz:group name="dev" password="password"/>
    <hz:network port="5701" port-auto-increment="false">
      <hz:join>
        <hz:multicast enabled="false"
          multicast-group="224.2.2.3"
          multicast-port="54327"/>
        <hz:tcp-ip enabled="true">
          <hz:members>10.10.1.2, 10.10.1.3</hz:members>
        </hz:tcp-ip>
      </hz:join>
    </hz:network>
    <hz:map name="map"
      backup-count="2"
      max-size="0"
      eviction-percentage="30"
      read-backup-data="true"
      eviction-policy="NONE"
      merge-policy="com.hazelcast.map.merge.PassThroughMergePolicy"/>
  </hz:config>
</hz:hazelcast>
```

- **Configuring Hazelcast Client**



```
<hz:client id="client">
  <hz:group name="${cluster.group.name}" password="${cluster.group.password}" />
  <hz:network connection-attempt-limit="3"
    connection-attempt-period="3000"
    connection-timeout="1000"
    redo-operation="true"
    smart-routing="true">
    <hz:member>10.10.1.2:5701</hz:member>
    <hz:member>10.10.1.3:5701</hz:member>
  </hz:network>
</hz:client>
```

## • Hazelcast Supported Type Configurations and Examples

- map
- multiMap
- replicatedmap
- queue
- topic
- reliableTopic
- set
- list
- executorService
- durableExecutorService
- scheduledExecutorService
- ringbuffer
- cardinalityEstimator
- idGenerator
- flakeIdGenerator
- atomicLong
- atomicReference
- semaphore
- countdownLatch
- lock

```

<hz:map id="map" instance-ref="client" name="map" lazy-init="true" />
<hz:multiMap id="multiMap" instance-ref="instance" name="multiMap"
  lazy-init="false" />
<hz:replicatedMap id="replicatedmap" instance-ref="instance"
  name="replicatedmap" lazy-init="false" />
<hz:queue id="queue" instance-ref="client" name="queue"
  lazy-init="true" depends-on="instance"/>
<hz:topic id="topic" instance-ref="instance" name="topic"
  depends-on="instance, client"/>
<hz:reliableTopic id="reliableTopic" instance-ref="instance" name="
reliableTopic"/>
<hz:set id="set" instance-ref="instance" name="set" />
<hz:list id="list" instance-ref="instance" name="list"/>
<hz:executorService id="executorService" instance-ref="client"
  name="executorService"/>
<hz:durableExecutorService id="durableExec" instance-ref="instance" name=
"durableExec"/>
<hz:scheduledExecutorService id="scheduledExec" instance-ref="instance" name=
"scheduledExec"/>
<hz:ringbuffer id="ringbuffer" instance-ref="instance" name="ringbuffer"/>
<hz:cardinalityEstimator id="cardinalityEstimator" instance-ref="instance" name
="cardinalityEstimator"/>
<hz:idGenerator id="idGenerator" instance-ref="instance"
  name="idGenerator"/>
<hz:flakeIdGenerator id="flakeIdGenerator" instance-ref="instance"
  name="flakeIdGenerator"/>
<hz:atomicLong id="atomicLong" instance-ref="instance" name="atomicLong"/>
<hz:atomicReference id="atomicReference" instance-ref="instance"
  name="atomicReference"/>
<hz:semaphore id="semaphore" instance-ref="instance" name="semaphore"/>
<hz:countDownLatch id="countDownLatch" instance-ref="instance"
  name="countDownLatch"/>
<hz:lock id="lock" instance-ref="instance" name="lock"/>

```

- **Supported Spring Bean Attributes**

Hazelcast also supports `lazy-init`, `scope` and `depends-on` bean attributes.

```

<hz:hazelcast id="instance" lazy-init="true" scope="singleton">
  ...
</hz:hazelcast>
<hz:client id="client" scope="prototype" depends-on="instance">
  ...
</hz:client>

```

- **Configuring MapStore and NearCache**

For map-store, you should set either the **class-name** or the **implementation** attribute.

```

<hz:config id="config">
  <hz:map name="map1">
    <hz:map-store enabled="true" class-name="com.foo.DummyStore"
      write-delay-seconds="0" />

    <hz:near-cache time-to-live-seconds="0"
      max-idle-seconds="60" eviction-policy="LRU" max-size="5000"
      invalidate-on-change="true" />
  </hz:map>

  <hz:map name="map2">
    <hz:map-store enabled="true" implementation="dummyMapStore"
      write-delay-seconds="0" />
  </hz:map>
</hz:config>

<bean id="dummyMapStore" class="com.foo.DummyStore" />

```

## 14.4.2. Enabling SpringAware Objects

You can mark Hazelcast Distributed Objects with `@SpringAware` if the object wants:

- to apply bean properties,
- to apply factory callbacks such as `ApplicationContextAware`, `BeanNameAware`,
- to apply bean post-processing annotations such as `InitializingBean`, `@PostConstruct`.

Hazelcast Distributed `ExecutorService`, or more generally any Hazelcast managed object, can benefit from these features. To enable `SpringAware` objects, you must first configure `HazelcastInstance` using `hazelcast` namespace as explained in [Configuring Spring](#) and add `<hz:spring-aware />` tag.

### SpringAware Examples

- Configure a Hazelcast Instance via Spring Configuration and define `someBean` as Spring Bean.
- Add `<hz:spring-aware />` to Hazelcast configuration to enable `@SpringAware`.

```

<beans xmlns="http://www.springframework.org/schema/beans"
       xmlns:xsi="http://www.w3.org/2001/XMLSchema-instance"
       xmlns:context="http://www.springframework.org/schema/context"
       xmlns:hz="http://www.hazelcast.com/schema/spring"
       xsi:schemaLocation="http://www.springframework.org/schema/beans
                           http://www.springframework.org/schema/beans/spring-beans-3.0.xsd
                           http://www.springframework.org/schema/context
                           http://www.springframework.org/schema/context/spring-context-
3.0.xsd
                           http://www.hazelcast.com/schema/spring
                           http://www.hazelcast.com/schema/spring/hazelcast-spring.xsd">

<context:component-scan base-package="..."/>

<hz:hazelcast id="instance">
  <hz:config>
    <hz:spring-aware />
    <hz:group name="dev" password="password"/>
    <hz:network port="5701" port-auto-increment="false">
      <hz:join>
        <hz:multicast enabled="false" />
        <hz:tcp-ip enabled="true">
          <hz:members>10.10.1.2, 10.10.1.3</hz:members>
        </hz:tcp-ip>
      </hz:join>
    </hz:network>
    ...
  </hz:config>
</hz:hazelcast>

<bean id="someBean" class="com.hazelcast.examples.spring.SomeBean"
      scope="singleton" />
...
</beans>

```

### Distributed Map SpringAware Example:

- Create a class called `SomeValue` which contains Spring Bean definitions like `ApplicationContext` and `SomeBean`.

```

@SpringAware
@Component("someValue")
@Scope("prototype")
public class SomeValue implements Serializable, ApplicationContextAware {

    private transient ApplicationContext context;
    private transient SomeBean someBean;
    private transient boolean init = false;

    public void setApplicationContext( ApplicationContext applicationContext )
        throws BeansException {
        context = applicationContext;
    }

    @Autowired
    public void setSomeBean( SomeBean someBean ) {
        this.someBean = someBean;
    }

    @PostConstruct
    public void init() {
        someBean.doSomethingUseful();
        init = true;
    }
}

```

- Get `SomeValue` Object from Context and put it into Hazelcast Distributed Map on the first member.

```

HazelcastInstance hazelcastInstance =
    (HazelcastInstance) context.getBean( "instance" );
SomeValue value = (SomeValue) context.getBean( "someValue" );
IMap<String, SomeValue> map = hazelcastInstance.getMap( "values" );
map.put( "key", value );

```

- Read `SomeValue` Object from Hazelcast Distributed Map and assert that `init` method is called since it is annotated with `@PostConstruct`.

```

HazelcastInstance hazelcastInstance =
    (HazelcastInstance) context.getBean( "instance" );
IMap<String, SomeValue> map = hazelcastInstance.getMap( "values" );
SomeValue value = map.get( "key" );
Assert.assertTrue( value.init );

```

### ExecutorService SpringAware Example:

- Create a Callable Class called `SomeTask` which contains Spring Bean definitions like

ApplicationContext, SomeBean.

```
@SpringAware
public class SomeTask
    implements Callable<Long>, ApplicationContextAware, Serializable {

    private transient ApplicationContext context;
    private transient SomeBean someBean;

    public Long call() throws Exception {
        return someBean.value;
    }

    public void setApplicationContext( ApplicationContext applicationContext )
        throws BeansException {
        context = applicationContext;
    }

    @Autowired
    public void setSomeBean( SomeBean someBean ) {
        this.someBean = someBean;
    }
}
```

- Submit `SomeTask` to two Hazelcast Members and assert that `someBean` is autowired.

```
HazelcastInstance hazelcastInstance =
    (HazelcastInstance) context.getBean( "instance" );
SomeBean bean = (SomeBean) context.getBean( "someBean" );

Future<Long> f = hazelcastInstance.getExecutorService("executorService")
    .submit(new SomeTask());
Assert.assertEquals(bean.value, f.get().longValue());

// choose a member
Member member = hazelcastInstance.getCluster().getMembers().iterator().next();

Future<Long> f2 = (Future<Long>) hazelcastInstance.getExecutorService("executorService")
    .submitToMember(new SomeTask(), member);
Assert.assertEquals(bean.value, f2.get().longValue());
```



Spring managed properties/fields are marked as `transient`.

### 14.4.3. Adding Caching to Spring

**Sample Code:** Please see our sample application for [Spring Cache](#).

As of version 3.1, Spring Framework provides support for adding caching into an existing Spring

application. Spring 3.2 and later versions support JCache compliant caching providers. You can also use JCache caching backed by Hazelcast if your Spring version supports JCache.

## Declarative Spring Cache Configuration

```
<cache:annotation-driven cache-manager="cacheManager" />

<hz:hazelcast id="instance">
  ...
</hz:hazelcast>

<bean id="cacheManager" class="com.hazelcast.spring.cache.HazelcastCacheManager">
  <constructor-arg ref="instance"/>
</bean>
```

Hazelcast uses its Map implementation for underlying cache. You can configure a map with your cache's name if you want to set additional configuration such as `ttl`.

```
<cache:annotation-driven cache-manager="cacheManager" />

<hz:hazelcast id="instance">
  <hz:config>
    ...

    <hz:map name="city" time-to-live-seconds="0" in-memory-format="BINARY" />
  </hz:config>
</hz:hazelcast>

<bean id="cacheManager" class="com.hazelcast.spring.cache.HazelcastCacheManager">
  <constructor-arg ref="instance"/>
</bean>
```

```
public interface IDummyBean {
    @Cacheable("city")
    String getCity();
}
```

## Defining Timeouts for Cache Read Operation

Starting with Hazelcast 3.8.4, you can define a timeout value for the get operations from your Spring cache. This may be useful for some cases, such as SLA requirements. Hazelcast provides a property to specify this timeout: `hazelcast.spring.cache.prop`. This can be specified as a Java property (using `-D`) or you can add this property to your Spring properties file (usually named as `application.properties`).

A sample usage is given below:

```
hazelcast.spring.cache.prop=defaultReadTimeout=2,cache1=10,cache2=20
```

The argument `defaultReadTimeout` applies to all of your Spring caches. If you want to define different timeout values for some specific Spring caches, you can provide them as a comma separated list as shown in the above sample usage. The values are in milliseconds. If you want to have no timeout for a cache, simply set it to `0` or a negative value.

## Declarative Hazelcast JCache Based Caching Configuration

```
<cache:annotation-driven cache-manager="cacheManager" />

<hz:hazelcast id="instance">
  ...
</hz:hazelcast>

<hz:cache-manager id="hazelcastJCacheCacheManager" instance-ref="instance" name="hazelcastJCacheCacheManager" />

<bean id="cacheManager" class="org.springframework.cache.jcache.JCacheCacheManager">
  <constructor-arg ref="hazelcastJCacheCacheManager" />
</bean>
```

You can use JCache implementation in both member and client mode. A cache manager should be bound to an instance. Instance can be referenced by `instance-ref` attribute or provided by `hazelcast.instance.name` property which is passed to CacheManager. Instance should be specified using one of these methods.



Instance name provided in properties overrides `instance-ref` attribute.

You can specify an URI for each cache manager with `uri` attribute.

```
<hz:cache-manager id="cacheManager2" name="cacheManager2" uri="testURI">
  <hz:properties>
    <hz:property name="hazelcast.instance.name">named-spring-hz-
instance</hz:property>
    <hz:property name="testProperty">testValue</hz:property>
  </hz:properties>
</hz:cache-manager>
```

## Annotation-Based Spring Cache Configuration

Annotation-Based Configuration does not require any XML definition. To perform Annotation-Based Configuration:

- Implement a `CachingConfiguration` class with related Annotations.



```

@Configuration
@EnableCaching
public class CachingConfiguration extends CachingConfigurerSupport {
    @Bean
    public CacheManager cacheManager() {
        ClientConfig config = new ClientConfig();
        HazelcastInstance client = HazelcastClient.newHazelcastClient(config);
        return new com.hazelcast.spring.cache.HazelcastCacheManager(client);
    }
    @Bean
    public KeyGenerator keyGenerator() {
        return null;
    }
}

```

- Launch Application Context and register `CachingConfiguration`.

```

AnnotationConfigApplicationContext context = new
AnnotationConfigApplicationContext();
context.register(CachingConfiguration.class);
context.refresh();

```

For more information about Spring Cache, please see [Spring Cache Abstraction](#).

#### 14.4.4. Configuring Hibernate Second Level Cache

**Sample Code:** Please see our [sample application](#) for Hibernate 2nd Level Cache Config.

If you are using Hibernate with Hazelcast as a second level cache provider, you can easily configure your `LocalSessionFactoryBean` to use a Hazelcast instance by passing Hazelcast instance name. That way, you can use the same `HazelcastInstance` as Hibernate L2 cache instance.

```

...
<bean id="sessionFactory"
      class="org.springframework.orm.hibernate3.LocalSessionFactoryBean"
      scope="singleton">
  <property name="dataSource" ref="dataSource"/>
  <property name="hibernateProperties">
    <props>
      ...
      <prop key="hibernate.cache.region.factory_class">
>com.hazelcast.hibernate.HazelcastLocalCacheRegionFactory</prop>
      <prop key="hibernate.cache.hazelcast.instance_name">
${hz.instance.name}</prop>
    </props>
  </property>
  ...
</bean>

```

### Hibernate RegionFactory Classes

- `com.hazelcast.hibernate.HazelcastLocalCacheRegionFactory`
- `com.hazelcast.hibernate.HazelcastCacheRegionFactory`

Please refer to Hibernate [Configuring RegionFactory](#) for more information.

### 14.4.5. Configuring Hazelcast Transaction Manager

**Sample Code:** Please see our [sample application](#) for Hazelcast Transaction Manager in our code samples repository.

Starting with Hazelcast 3.7, you can get rid of the boilerplate code to begin, commit or rollback transactions by using `HazelcastTransactionManager` which is a `PlatformTransactionManager` implementation to be used with Spring Transaction API.

#### Sample Configuration for Hazelcast Transaction Manager

You need to register `HazelcastTransactionManager` as your transaction manager implementation and also you need to register `ManagedTransactionalTaskContext` to access transactional data structures within your service class.

```

...
<hz:hazelcast id="instance">
    ...
</hz:hazelcast>
...
<tx:annotation-driven transaction-manager="transactionManager"/>
<bean id="transactionManager" class=
"com.hazelcast.spring.transaction.HazelcastTransactionManager">
    <constructor-arg ref="instance"/>
</bean>
<bean id="transactionalContext" class=
"com.hazelcast.spring.transaction.ManagedTransactionalTaskContext">
    <constructor-arg ref="transactionManager"/>
</bean>
<bean id="YOUR_SERVICE" class="YOUR_SERVICE_CLASS">
    <property name="transactionalTaskContext" ref="transactionalContext"/>
</bean>
...

```

### Sample Transactional Method

```

public class ServiceWithTransactionalMethod {

    private TransactionalTaskContext transactionalTaskContext;

    @Transactional
    public void transactionalPut(String key, String value) {
        transactionalTaskContext.getMap("testMap").put(key, value);
    }

    ...
}

```

After marking your method as `Transactional` either declaratively or by annotation and accessing the data structure through the `TransactionalTaskContext`, `HazelcastTransactionManager` will begin, commit or rollback the transaction for you.

#### 14.4.6. Best Practices

Spring tries to create a new `Map/Collection` instance and fill the new instance by iterating and converting values of the original `Map/Collection` (`IMap`, `IQueue`, etc.) to required types when generic type parameters of the original `Map/Collection` and the target property/attribute do not match.

Since Hazelcast `Map`'s/`Collection`'s are designed to hold very large data which a single machine cannot carry, iterating through whole values can cause out of memory errors.

To avoid this issue, the target property/attribute can be declared as un-typed `Map/Collection` as shown below.

```

public class SomeBean {
    @Autowired
    IMap map; // instead of IMap<K, V> map

    @Autowired
    IQueue queue; // instead of IQueue<E> queue
    ...
}

```

Or, parameters of injection methods (constructor, setter) can be un-typed as shown below.

```

public class SomeBean {

    IMap<K, V> map;
    IQueue<E> queue;

    // Instead of IMap<K, V> map
    public SomeBean(IMap map) {
        this.map = map;
    }

    ...

    // Instead of IQueue<E> queue
    public void setQueue(IQueue queue) {
        this.queue = queue;
    }
    ...
}

```



For more information please see [Spring issue-3407](#).

## 15. Storage

This chapter describes Hazelcast's High-Density Memory Store and Hot Restart Persistence features along with their configurations and gives recommendations on the storage sizing.

### 15.1. High-Density Memory Store

#### Hazelcast IMDG Enterprise HD

By default, data structures in Hazelcast store data on heap in serialized form for highest data compaction; yet, these data structures are still subject to Java Garbage Collection (GC). Modern hardware has much more available memory. If you want to make use of that hardware and scale up by specifying higher heap sizes, GC becomes an increasing problem: the application faces long GC pauses that make the application unresponsive. Also, you may get out of memory errors if you

fill your whole heap. Garbage collection, which is the automatic process that manages the application's runtime memory, often forces you into configurations where multiple JVMs with small heaps (sizes of 2-4GB per member) run on a single physical hardware device to avoid garbage collection pauses. This results in oversized clusters to hold the data and leads to performance level requirements.

In **Hazelcast IMDG Enterprise HD**, the High-Density Memory Store is Hazelcast's new enterprise in-memory storage solution. It solves garbage collection limitations so that applications can exploit hardware memory more efficiently without the need of oversized clusters. High-Density Memory Store is designed as a pluggable memory manager which enables multiple memory stores for different data structures. These memory stores are all accessible by a common access layer that scales up to terabytes of the main memory on a single JVM by minimizing the GC pressure. High-Density Memory Store enables predictable application scaling and boosts performance and latency while minimizing garbage collection pauses.

This foundation includes, but is not limited to, storing keys and values next to the heap in a native memory region.

High-Density Memory Store is currently provided for the following Hazelcast features and implementations:

- [Map](#)
- [JCache Implementation](#)
- [Near Cache](#)
- [Hot Restart Persistence](#)
- [Java Client](#), when using the Near Cache for client
- [Web Session Replications](#)
- [Hibernate 2nd Level Caching](#)

### 15.1.1. Configuring High-Density Memory Store

To use the High-Density memory storage, the native memory usage must be enabled using the programmatic or declarative configuration. Also, you can configure its size, memory allocator type, minimum block size, page size and metadata space percentage.

- **size:** Size of the total native memory to allocate in megabytes. Its default value is **512 MB**.
- **allocator type:** Type of the memory allocator. Available values are as follows:
  - **STANDARD:** This option is used internally by Hazelcast's POOLED allocator type or for debugging/testing purposes.
    - With this option, the memory is allocated or deallocated using your operating system's default memory manager.
    - It uses GNU C Library's standard `malloc()` and `free()` methods which are subject to contention on multithreaded/multicore systems.
    - Memory operations may become slower when you perform a lot of small allocations and deallocations.

- It may cause large memory fragmentations, unless you use a method in the background that emphasizes fragmentation avoidance, such as `jemalloc()`. Note that a large memory fragmentation can trigger the Linux Out of Memory Killer if there is no swap space enabled in your system. Even if the swap space is enabled, the killer can be again triggered if there is not enough swap space left.
- If you still want to use the operating system's default memory management, you can set the allocator type to `STANDARD` in your native memory configuration.
- **POOLED**: This is the default option, Hazelcast's own pooling memory allocator.
  - With this option, memory blocks are managed using internal memory pools.
  - It allocates memory blocks, each of which has a 4MB page size by default, and splits them into chunks or merges them to create larger chunks when required. Sizing of these chunks follows the [buddy memory allocation](#) algorithm, i.e. power-of-two sizing.
  - It never frees memory blocks back to the operating system. It marks disposed memory blocks as available to be used later, meaning that these blocks are reusable.
  - Memory allocation and deallocation operations (except the ones requiring larger sizes than the page size) do not interact with the operating system mostly.
  - For memory allocation, it tries to find the requested memory size inside the internal memory pools. If it cannot be found, then it interacts with the operating system.
- **minimum block size**: Minimum size of the blocks in bytes to split and fragment a page block to assign to an allocation request. It is used only by the **POOLED** memory allocator. Its default value is **16 bytes**.
- **page size**: Size of the page in bytes to allocate memory as a block. It is used only by the **POOLED** memory allocator. Its default value is  $1 \ll 22 = 4194304$  Bytes, about **4 MB**.
- **metadata space percentage**: Defines the percentage of the allocated native memory that is used for internal memory structures by the High-Density Memory for tracking the used and available memory blocks. It is used only by the **POOLED** memory allocator. Its default value is **12.5**. Please note that when the memory runs out, you will get a `NativeOutOfMemoryException`; if your store has a big size of entries, you should consider increasing this percentage.

The following is the programmatic configuration example.

```
MemorySize memorySize = new MemorySize(512, MemoryUnit.MEGABYTES);
NativeMemoryConfig nativeMemoryConfig =
    new NativeMemoryConfig()
        .setAllocatorType(NativeMemoryConfig.MemoryAllocatorType.POOLED)
        .setSize(memorySize)
        .setEnabled(true)
        .setMinBlockSize(16)
        .setPageSize(1 << 20);
```

The following is the declarative configuration example.

```
<native-memory allocator-type="POOLED" enabled="true">
  <size unit="MEGABYTES" value="512"/>
  <min-block-size>16</min-block-size>
  <page-size>4194304</page-size>
  <metadata-space-percentage>12.5</metadata-space-percentage>
</native-memory>
```



You can check whether there is enough free physical memory for the requested number of bytes using the system property `hazelcast.hidensity.check.freememory`. Please see the [System Properties appendix](#) on how to use Hazelcast system properties.

## 15.2. Sizing Practices

Data in Hazelcast is both active data and backup data for high availability, so the total memory footprint is the size of active data plus the size of backup data. If you use a single backup, it means the total memory footprint is two times the active data (active data + backup data). If you use, for example, two backups, then the total memory footprint is three times the active data (active data + backup data + backup data).

If you use only heap memory, each Hazelcast member with a 4 GB heap should accommodate a maximum of 3.5 GB of total data (active and backup). If you use the High-Density Memory Store, up to 75% of the configured physical memory footprint may be used for active and backup data, with headroom of 25% for normal memory fragmentation. In both cases, however, you should also keep some memory headroom available to handle any member failure or explicit member shutdown. When a member leaves the cluster, the data previously owned by the newly offline member will be distributed among the remaining members. For this reason, we recommend that you plan to use only 60% of available memory, with 40% headroom to handle member failure or shutdown.

## 15.3. Hot Restart Persistence

### Hazelcast IMDG Enterprise HD

This chapter explains the Hazelcast's Hot Restart Persistence feature, introduced with Hazelcast 3.6. Hot Restart Persistence provides fast cluster restarts by storing the states of the cluster members on the disk. This feature is currently provided for the Hazelcast map data structure and the Hazelcast JCache implementation.

### 15.3.1. Hot Restart Persistence Overview

Hot Restart Persistence enables you to get your cluster up and running swiftly after a cluster restart. A restart can be caused by a planned shutdown (including rolling upgrades) or a sudden cluster-wide crash, e.g., power outage. For Hot Restart Persistence, required states for Hazelcast clusters and members are introduced. Please refer to the [Managing Cluster and Member States section](#) for information on the cluster and member states. The purpose of the Hot Restart Persistence is to provide a maintenance window for member operations and restart the cluster in a

fast way. It is not meant to recover the catastrophic shutdown of one member.

### 15.3.2. Hot Restart Types

The Hot Restart feature is supported for the following restart types:

- **Restart after a planned shutdown:**

- The cluster is shut down completely and restarted with the exact same previous setup and data.

You can shut down the cluster completely using the method `HazelcastInstance.getCluster().shutdown()` or you can manually change the cluster state to `PASSIVE` and then shut down each member one by one. When you send the command to shut the cluster down, i.e. `HazelcastInstance.getCluster().shutdown()`, the members that are not in the `PASSIVE` state temporarily change their states to `PASSIVE`. Then, each member shuts itself down by calling the method `HazelcastInstance.shutdown()`.

Difference between explicitly changing state to `PASSIVE` before shutdown and shutting down cluster directly via `HazelcastInstance.getCluster().shutdown()` is, on latter case when cluster is restarted, cluster state will be in the latest state before shutdown. That means if cluster is `ACTIVE` before shutdown, cluster state will automatically become `ACTIVE` after restart is completed.

- Rolling restart: The cluster is restarted intentionally member by member. For example, this could be done to install an operating system patch or new hardware.

To be able to shut down the cluster member by member as part of a planned restart, each member in the cluster should be in the `FROZEN` or `PASSIVE` state. After the cluster state is changed to `FROZEN` or `PASSIVE`, you can manually shut down each member by calling the method `HazelcastInstance.shutdown()`. When that member is restarted, it will rejoin the running cluster. After all members are restarted, the cluster state can be changed back to `ACTIVE`.

- **Restart after a cluster crash:** The cluster is restarted after all its members crashed at the same time due to a power outage, networking interruptions, etc.

### 15.3.3. Restart Process

During the restart process, each member waits to load data until all the members in the partition table are started. During this process, no operations are allowed. Once all cluster members are started, Hazelcast changes the cluster state to `PASSIVE` and starts to load data. When all data is loaded, Hazelcast changes the cluster state to its previous known state before shutdown and starts to accept the operations which are allowed by the restored cluster state.

If a member fails to either start, join the cluster in time (within the timeout), or load its data, then that member will be terminated immediately. After the problems causing the failure are fixed, that member can be restarted. If the cluster start cannot be completed in time, then all members will fail to start. Please refer to the [Configuring Hot Restart section](#) for defining timeouts.



In the case of a restart after a cluster crash, the Hot Restart feature realizes that it was not a clean shutdown and Hazelcast tries to restart the cluster with the last saved data following the process explained above. In some cases, specifically when the cluster crashes while it has an ongoing partition migration process, currently it is not possible to restore the last saved state.

### Restart of a Member in Running Cluster

Assume the following:

- You have a cluster consisting of members A, B and C with Hot Restart enabled, which is initially stable.
- Member B is killed.
- Member B restarts.

Since only a single member has failed, the cluster performed the standard High Availability routine by recovering member B's data from backups and redistributing the data among the remaining members (the members A and C in this case). Member B's persisted Hot Restart data is completely irrelevant.

Furthermore, when a member starts with existing Hot Restart data, it expects to find itself within a cluster that has been shut down as a whole and is now restarting as a whole. Since the reality is that the cluster has been running all along, member B's persisted cluster state does not match the actual state. Therefore, member B aborts initialization and shuts down.

As another scenario, assume the following:

- You have a cluster consisting of members A, B and C with Hot Restart enabled, which is initially stable.
- Member B is killed.
- Member B's Hot Restart [base directory](#) (`base-dir`) must be deleted.
- Member B restarts.

Now member B joins the cluster as a fresh, empty member. The cluster will assign some partitions to it, unrelated to the partitions it owned before going down.

### 15.3.4. Force Start

A member can crash permanently and then be unable to recover from the failure. In that case, restart process cannot be completed since some of the members do not start or fail to load their own data. In that case, you can force the cluster to clean its persisted data and make a fresh start. This process is called **force start**.

Assume the following which is a valid scenario to use force start:

- You have a cluster consisting of members A and B which is initially stable.
- Cluster transitions into `FROZEN` or `PASSIVE` state.
- Cluster gracefully shuts down.

- Member A restarts, but member B does not.
- Member A uses its Hot Restart data to initiate the Hot Restart procedure.
- Since it knows the cluster originally contained member B as well, it waits for it to join.
- This never happens.
- Now you have the choice to Force Start the cluster without member B.
- Cluster discards all Hot Restart data and starts empty.

You can trigger the force start process using the Management Center, REST API and cluster management scripts.

Please note that force start is a destructive process, which results in deletion of persisted Hot Restart data.

Please refer to the [Hot Restart functionality](#) of the Management Center section to learn how you can perform a force start using the Management Center.

### 15.3.5. Partial Start

When one or more members fail to start or have incorrect Hot Restart data (stale or corrupted data) or fail to load their Hot Restart data, cluster will become incomplete and restart mechanism cannot proceed. One solution is to use [Force Start](#) and make a fresh start with existing members. Another solution is to do a partial start.

Partial start means that the cluster will start with an incomplete member set. Data belonging to those missing members will be assumed lost and Hazelcast will try to recover missing data using the restored backups. For example, if you have minimum two backups configured for all maps and caches, then a partial start up to two missing members will be safe against data loss. If there are more than two missing members or there are maps/caches with less than two backups, then data loss is expected.

Partial start is controlled by `cluster-data-recovery-policy` configuration parameter and is not allowed by default. To enable partial start, one of the configuration values `PARTIAL_RECOVERY_MOST_RECENT` or `PARTIAL_RECOVERY_MOST_COMPLETE` should be set. Please see [Configuring Hot Restart section](#) for details.

When partial start is enabled, Hazelcast can perform a partial start automatically or manually, in case of some members are unable to restart successfully. Partial start proceeds automatically when some members fail to start and join to the cluster in `validation-timeout-seconds`. After the `validation-timeout-seconds` duration is passed, Hot Restart chooses to perform partial start with the members present in the cluster. Moreover, partial start can be requested manually using the [Management Center](#), [REST API](#) and [cluster management scripts](#) before the `validation-timeout-seconds` duration passes.

The other situation to decide to perform a partial start is failures during the data load phase. When Hazelcast learns data load result of all members which have passed the validation step, it automatically performs a partial start with the ones which have successfully restored their Hot Restart data. Please note that partial start does not expect every member to succeed in the data load

step. It completes the process when it learns data load result for every member and there is at least one member which has successfully restored its Hot Restart data. Relatedly, if it cannot learn data load result of all members before `data-load-timeout-seconds` duration, it proceeds with the ones which have already completed the data load process.

Selection of members to perform partial start among live members is done according to the `cluster-data-recovery-policy` configuration. Set of members which are not selected by the `cluster-data-recovery-policy` are called `Excluded members` and they are instructed to perform `force start`. Excluded members are allowed to join cluster only when they clean their Hot Restart data and make a fresh-new start. This is a completely automatic process. For instance, if you start the missing members after partial start is completed, they clean their Hot Restart data and join to the cluster.

Please note that partial start is a destructive process. Once it is completed, it cannot be repeated with a new configuration. For this reason, one may need to perform the partial start process manually. Automatic behavior of partial start relies on `validation-timeout-seconds` and `data-load-timeout-seconds` configuration values. If you need to control the process manually, `validation-timeout-seconds` and `data-load-timeout-seconds` properties can be set to very big values so that Hazelcast cannot make progress on timeouts automatically. Then, the overall process can be managed manually via aforementioned methods, i.e. Management Center, REST API and cluster management scripts.

### 15.3.6. Configuring Hot Restart

You can configure Hot Restart feature programmatically or declaratively. There are two steps of configuration:

1. Enabling and configuring the Hot Restart feature globally in your Hazelcast configuration: This is done using the configuration element `hot-restart-persistence`. Please see the [Global Hot Restart Configuration section](#) below.
2. Enabling and configuring the Hazelcast data structures to use the Hot Restart feature: This is done using the configuration element `hot-restart`. Please see the [Per Data Structure Hot Restart Configuration section](#) below.

#### Global Hot Restart Configuration

This is where you configure the Hot Restart feature itself using the `hot-restart-persistence` element. The following are the descriptions of its attribute and sub-elements:

- `enabled`: Attribute of the `hot-restart-persistence` element which specifies whether the feature is globally enabled in your Hazelcast configuration. Set this attribute to `true` if you want any of your data structures to use the Hot Restart feature.
- `base-dir`: Specifies the directory where the Hot Restart data will be stored. The default value for `base-dir` is `hot-restart`. You can use the default value, or you can specify the value of another folder containing the Hot Restart configuration, but it is mandatory that `base-dir` element has a value. This directory will be created automatically if it does not exist. A single `base-dir` can be used only and only by a single Hazelcast member, it cannot be shared by multiple members. An attempt to use the same `base-dir` by multiple members will make these members abort the startup process except one which wins the ownership of the directory.

- **backup-dir**: Specifies the directory under which Hot Restart snapshots (Hot Backups) will be stored. Please see the [Hot Backup section](#) for more information.
- **parallelism**: Level of parallelism in Hot Restart Persistence. There will be this many IO threads, each writing in parallel to its own files. During the Hot Restart procedure, this many IO threads will be reading the files and this many rebuilder threads will be rebuilding the Hot Restart metadata. The default value for this property is 1. This is a good default in most but not all cases. You should measure the raw IO throughput of your infrastructure and test with different values of parallelism. In some cases such as dedicated hardware higher parallelism can yield more throughput of Hot Restart. In other cases such as running on EC2, it can yield diminishing returns - more thread scheduling, more contention on IO and less efficient garbage collection.
- **validation-timeout-seconds**: Validation timeout for the Hot Restart process when validating the cluster members expected to join and the partition table on the whole cluster.
- **data-load-timeout-seconds**: Data load timeout for the Hot Restart process. All members in the cluster should finish restoring their local data before this timeout.
- **cluster-data-recovery-policy**: Specifies the data recovery policy that will be respected during Hot Restart cluster start. Valid values are;
  - **FULL\_RECOVERY\_ONLY**: Starts the cluster only when all expected members are present and correct. Otherwise, it fails. This is the default value.
  - **PARTIAL\_RECOVERY\_MOST\_RECENT**: Starts the cluster with the members which have most up-to-date partition table and successfully restored their data. All other members will leave the cluster and force start themselves. If no member restores its data successfully, cluster start fails.
  - **PARTIAL\_RECOVERY\_MOST\_COMPLETE**: Starts the cluster with the largest group of members which have the same partition table version and successfully restored their data. All other members will leave the cluster and force start themselves. If no member restores its data successfully, cluster start fails.

## Per Data Structure Hot Restart Configuration

This is where you configure the data structures of your choice, so that they can have the Hot Restart feature. This is done using the **hot-restart** configuration element. As it is explained in the [introduction](#) paragraph, Hot Restart feature is currently supported by Hazelcast map data structure and JCache implementation (**map** and **cache**), each of which has the **hot-restart** configuration element. The following are the descriptions of this element's attribute and sub-element:

- **enabled**: Attribute of the **hot-restart** element which specifies whether the Hot Restart feature is enabled for the related data structure. Its default value is **false**.
- **fsync**: Turning on **fsync** guarantees that data is persisted to the disk device when a write operation returns successful response to the caller. By default, **fsync** is turned off (**false**). That means data will be persisted to the disk device eventually, instead of on every disk write. This generally provides a better performance.

## Hot Restart Configuration Examples

The following are example configurations for a Hazelcast map and JCache implementation.

## Declarative Configuration:

An example configuration is shown below.

```
<hazelcast>
  ...
  <hot-restart-persistence enabled="true">
    <base-dir>/mnt/hot-restart</base-dir>
    <parallelism>1</parallelism>
    <validation-timeout-seconds>120</validation-timeout-seconds>
    <data-load-timeout-seconds>900</data-load-timeout-seconds>
    <cluster-data-recovery-policy>FULL_RECOVERY_ONLY</cluster-data-recovery-policy>
  </hot-restart-persistence>
  ...
  <map name="test-map">
    <hot-restart enabled="true">
      <fsync>>false</fsync>
    </hot-restart>
  </map>
  ...
  <cache name="test-cache">
    <hot-restart enabled="true">
      <fsync>>false</fsync>
    </hot-restart>
  </cache>
  ...
</hazelcast>
```

## Programmatic Configuration:

The programmatic equivalent of the above declarative configuration is shown below.

```

Config config = new Config();
HotRestartPersistenceConfig hotRestartPersistenceConfig = new
HotRestartPersistenceConfig()
.setEnabled(true)
.setBaseDir(new File("/mnt/hot-restart"))
.setParallelism(1)
.setValidationTimeoutSeconds(120)
.setDataLoadTimeoutSeconds(900)
.setClusterDataRecoveryPolicy(HotRestartClusterDataRecoveryPolicy.FULL_RECOVERY_ONLY);
config.setHotRestartPersistenceConfig(hotRestartPersistenceConfig);

MapConfig mapConfig = config.getMapConfig("test-map");
mapConfig.getHotRestartConfig().setEnabled(true);

CacheSimpleConfig cacheConfig = config.getCacheConfig("test-cache");
cacheConfig.getHotRestartConfig().setEnabled(true);

```

### 15.3.7. Moving/Copying Hot Restart Data

After Hazelcast member owning the Hot Restart data is shutdown, Hot Restart `base-dir` can be copied/moved to a different server (which may have different IP address and/or different number of CPU cores) and Hazelcast member can be restarted using the existing Hot Restart data on that new server. Having a new IP address does not affect Hot Restart, since it does not rely on the IP address of the server but instead uses `Member` UUID as a unique identifier.

This flexibility provides; - ability to replace one or more faulty servers with new ones easily without touching remaining cluster - ability to use Hot Restart on cloud environments easily. Sometimes cloud providers do not preserve IP addresses on restart or after shutdown. Also it is possible to startup whole cluster on a different set of machines. - ability to copy production data to test environment, so that a more functional test cluster can be setup

Unfortunately having different number of CPU cores is not that straightforward. Hazelcast partition threads, by default, will use a heuristic from the number of cores, e.g., `# of partition threads = # of CPU cores`. When Hazelcast member is started on a server with a different CPU core count, number of Hazelcast partition threads will change and that will make Hot Restart fail during startup. Solution is to explicitly set number of Hazelcast partition threads (`hazelcast.operation.thread.count` system property) and Hot Restart `parallelism` configuration and use the same parameters on the new server. For setting system properties see [System Properties appendix](#).

### 15.3.8. Hot Restart Persistence Design Details

Hazelcast's Hot Restart Persistence uses the log-structured storage approach. The following is a top-level design description:

- The only kind of update operation on persistent data is *appending*.

- What is appended are facts about events that happened to the data model represented by the store; either a new value was assigned to a key or a key was removed.
- Each record associated with a key makes stale the previous record that was associated with that key.
- Stale records contribute to the amount of *garbage* present in the persistent storage.
- Measures are taken to remove garbage from the storage.

This kind of design focuses almost all of the system's complexity into the garbage collection (GC) process, stripping down the client's operation to the bare necessity of guaranteeing persistent behavior: a simple file append operation. Consequently, the latency of operations is close to the theoretical minimum in almost all cases. Complications arise only during prolonged periods of maximum load; this is where the details of the GC process begin to matter.

### 15.3.9. Concurrent, Incremental, Generational GC

In order to maintain the lowest possible footprint in the update operation latency, the following properties are built into the garbage collection process:

- A dedicated thread performs the GC. In Hazelcast terms, this thread is called the Collector and the application thread is called the Mutator.
- On each update there is metadata to be maintained; this is done asynchronously by the Collector thread. The Mutator enqueues update events to the Collector's work queue.
- The Collector keeps draining its work queue at all times, including the time it goes through the GC cycle. Updates are taken into account at each stage in the GC cycle, preventing the copying of already dead records into compacted files.
- All GC-induced I/O competes for the same resources as the Mutator's update operations. Therefore, measures are taken to minimize the impact of I/O done during GC:
  - data is never read from files, but from RAM;
  - a heuristic scheme is employed which minimizes the number of bytes written to disk for each kilobyte of reclaimed garbage;
  - measures are also taken to achieve a good interleaving of Collector and Mutator operations, minimizing latency outliers perceived by the Mutator.

#### I/O Minimization Scheme

The success of this scheme is subject to a bet on the Weak Generational Garbage Hypothesis, which states that a new record entering the system is likely to become garbage soon. In other words, a key updated now is more likely than average to be updated again soon.

The scheme was taken from the seminal Sprite LFS paper, [Rosenblum, Ousterhout, \*The Design and Implementation of a Log-Structured File System\*](#). The following is an outline of the paper:

- Data is not written to one huge file, but to many files of moderate size (8 MB) called "chunks".
- Garbage is collected incrementally, i.e. by choosing several chunks, then copying all their live data to new chunks, then deleting the old ones.

- I/O is minimized using a collection technique which results in a bimodal distribution of chunks with respect to their garbage content: most files are either almost all live data or they are all garbage.
- The technique consists of two main principles:
  - Chunks are selected based on their *Cost-Benefit factor* (see below).
  - Records are sorted by age before copying to new chunks.

### Cost-Benefit Factor

The Cost-Benefit factor of a chunk consists of two components multiplied together:

1. The ratio of benefit (amount of garbage that can be collected) to I/O cost (amount of live data to be written).
2. The age of the data in the chunk, measured as the age of the youngest record it contains.

The essence is in the second component: given equal amount of garbage in all chunks, it will make the young ones less attractive to the Collector. Assuming the generational garbage hypothesis, this will allow the young chunks to quickly accumulate more garbage. On the flip side, it will also ensure that even files with little garbage are eventually garbage collected. This removes garbage which would otherwise linger on, thinly spread across many chunk files.

Sorting records by age will group young records together in a single chunk and will do the same for older records. Therefore the chunks will either tend to keep their data live for a longer time, or quickly become full of garbage.

### 15.3.10. Hot Restart Performance Considerations

In this section you can find performance test summaries which are results of benchmark tests performed with a single Hazelcast member running on a physical server and on AWS R3.

#### Performance on a Physical Server

The member has the following:

- An IMap data structure with High-Density Memory Store.
- Its data size is changed for each test, started from 10 GB to 500 GB (each map entry has a value of 1 KB).

The tests investigate the write and read performance of Hot Restart Persistence and are performed on HP ProLiant servers with RHEL 7 operating system using Hazelcast Simulator.

The following are the specifications of the server hardware used for the test:

- CPU: 2x Intel® Xeon® CPU E5-2687W v3 @ 3.10GHz – with 10 cores per processor. Total 20 cores, 40 with hyper threading enabled.
- Memory: 768GB 2133 MHz memory 24x HP 32GB 4Rx4 PC4-2133P-L Kit

The following are the storage media used for the test:



- A hot-pluggable 2.5 inch HDD with 1 TB capacity and 10K RPM.
- An SSD, Light Endurance PCIe Workload Accelerator.

The below table shows the test results.

Storage Drives	Reading				Writing		
	Data Size	Operation Threads	Restart time	Read Throughput	fsync	User threads	Write Throughput
SSD	500 GB	8	404 sec	1.24 GB/s	off	16	220,000 ops/sec
SSD	300 GB	8	245 sec	1.22 GB/s	off	16	240,000 ops/sec
SSD	100 GB	40	78 sec	1.28 GB/s	off	40	310,000 ops/sec
SSD	100 GB	8	76 sec	1.22 GB/s	off	16	310,000 ops/sec
SSD	10 GB	8	7 sec	~1.3 GB/s	off	16	305,000 ops/sec
SSD	10 GB	1	43 sec	0.23 GB/s	off	1	45,000 ops/sec
HDD	10 GB	8	207 sec	0.05 GB/s	off	16	36,700 ops/sec
HDD	10 GB	4	182 sec	0.05 GB/s	off	4	35,000 ops/sec
HDD	10 GB	1	130 sec	0.08 GB/s	off	1	41,800 ops/sec

### Performance on AWS R3

The member has the following:

- An IMap data structure with High-Density Memory Store.
- IMap has 40 million distinct keys, each map entry is 1 KB.
- High-Density Memory Store is 59 GiB whose 19% is metadata.
- Hot Restart is configured with `fsync` turned off.
- Data size reloaded on restart is 38 GB.

The tests investigate the write and read performance of Hot Restart Persistence and are performed on R3.2xlarge and R3.4xlarge EC2 instances using Hazelcast Simulator.

The following are the AWS storage types used for the test:

- Elastic Block Storage (EBS) General Purpose SSD (GP2).
- Elastic Block Storage with Provisioned IOPS (IO1). Provisioned 10,000 IOPS on a 340 GiB volume, enabled EBS-optimized on instance.
- SSD-backed instance store.

The below table shows the test results.

Setup		Reading		Writing	
Storage Type	op/user threads	Restart time	Effective read throughput	Throughput	Latency by pctile 3-4-5-6-7 nines
R3.2xlarge					
EBS gp2 1 TB (3,000 IOPS)	4/4	360 sec	96 MB/s	45,000 ops/sec	
EBS Provisioned 10,000 IOPS	4/4	340 sec	107 MB/s	50,000 ops/sec	3-14-150-600-825 ms
Instance store	4/4	182 sec	210 MB/s	50,000 ops/sec	3-15-240-400-800 ms
Instance store	4/10	184 sec	207 MB/s	65,000 ops/sec	--
Instance store	8/20	180 sec	210 MB/s	62,000 ops/sec	12-175-370-600-825 ms
None (HR off)	4/10	--	--	153,000 ops/sec	---
None (HR off)	8/20	--	--	180,000 ops/sec	---
R3.4xlarge					
EBS Provisioned 10,000 IOPS	4/4	160 sec	220 MB/s	66,000 ops/sec	0.2-8-47-120-420 ms
EBS Provisioned 10,000 IOPS	8/8	150 sec	230 MB/s	80,000 ops/sec	5-15-80-280-443 ms
Instance store	8/8	95 sec	420 MB/s	80,000 ops/sec	4.5-17-79-200-375 ms
Instance store	8/20	94 sec	420 MB/s	113,000 ops/sec	--
None (HR off)	4/4	--	--	91,100 ops/sec	--
None (HR off)	8/20	--	--	237,000 ops/sec	--

### 15.3.11. Hot Backup

During Hot Restart operations you can take a snapshot of the Hot Restart Store at a certain point in time. This is useful when you wish to bring up a new cluster with the same data or parts of the data. The new cluster can then be used to share load with the original cluster, to perform testing, QA or reproduce an issue on production data.

Simple file copying of a currently running cluster does not suffice and can produce inconsistent snapshots with problems such as resurrection of deleted values or missing values.

#### Configuring Hot Backup

To create snapshots you must first configure the Hot Restart backup directory. You can configure the directory programmatically or declaratively using the following configuration element:

- **backup-dir**: This element is included in the `hot-restart-persistence` and denotes the destination under which backups will be stored. If this element is not defined, hot backup will be disabled. If a directory is defined which does not exist, it will be created on the first backup. To avoid clashing data on multiple backups, each backup has a unique sequence ID which determines the name of the directory which will contain all Hot Restart data. This unique directory is created as a subdirectory of the configured `backup-dir`.

The following are examples configurations for Hot backup.

#### Declarative Configuration:

An example configuration is shown below.

```

<hazelcast>
  ...
  <hot-restart-persistence enabled="true">
    ...
    <backup-dir>/mnt/hot-backup</backup-dir>
    ...
  </hot-restart-persistence>
  ...
</hazelcast>

```

### Programmatic Configuration:

The programmatic equivalent of the above declarative configuration is shown below.

```

HotRestartPersistenceConfig hotRestartPersistenceConfig = new
HotRestartPersistenceConfig();
hotRestartPersistenceConfig.setBackupDir(new File("/mnt/hot-backup"));
...
config.setHotRestartPersistenceConfig(hotRestartPersistenceConfig);

```

### Using Hot Backup

Once configured, you can initiate a new backup via API or from the Management Center. The backup is started transactionally and cluster-wide. This means that either all or none of the members will start the same backup. The member which receives the backup request will determine a new backup sequence ID and send that information to all members. If all members respond that no other backup is currently in progress and that no other backup request has already been made, then the coordinating member will command the other members to start the actual backup process. This will create a directory under the configured `backup-dir` with the name `backup-  
<backupSeq>` and start copying the data from the original store.

The backup process is initiated nearly instantaneously on all members. Note that since there is no limitation as to when the backup process is initiated, it may be initiated during membership changes, partition table changes or during normal data update. Some of these operations may not be completed fully yet, which means that some members will backup some data while some members will backup a previous version of the same data. This will usually be solved by the anti-entropy mechanism on the new cluster which will reconcile different versions of the same data. Please check the [Achieving High Consistency of Backup Data section](#) for more information.

The duration of the backup process and the disk data usage drastically depends on what is supported by the system and the configuration. Please check the [Achieving high performance of backup process section](#) for more information on achieving better resource usage of the backup process.

Following is an example of how to trigger the Hot Backup via API:

```
HotRestartService service = instance.getCluster().getHotRestartService();
service.backup();
```

The `backupSeq` is generated by the hot backup process, but you can define your own backup sequences as shown below:

```
HotRestartService service = instance.getCluster().getHotRestartService();
long backupSeq = ...
service.backup(backupSeq);
```

Keep in mind that the backup will fail if any member contains a backup directory with the name `backup-backupSeq`, where `backupSeq` is the given sequence.

### Starting the Cluster From a Hot Backup

As mentioned in the previous section, hot backup process creates subdirectories named `backup-backupSeq` under the configured `hot backup directory` (i.e., `backup-dir`). When starting your cluster with data from a hot backup, you need to set the `base directory` (i.e., `base-dir`) to the desired backup subdirectory.

Let's say you have configured your hot backup directory as follows:

```
<hazelcast>
  ...
  <hot-restart-persistence enabled="true">
    ...
    <backup-dir>/mnt/hot-backup</backup-dir>
    ...
  </hot-restart-persistence>
  ...
</hazelcast>
```

And let's say you have a subdirectory named `backup-20180ct24` under the backup directory `/mnt/hot-backup`. When you want to start your cluster with data from this backup (`backup-20180ct24`), here is the configuration you should have for the `base-dir` while starting the cluster:

```

<hazelcast>
  ...
  <hot-restart-persistence enabled="true">
    ...
    <base-dir>backup-20180ct24</base-dir>
    <parallelism>1</parallelism>
    ...
  </hot-restart-persistence>
  ...
  <map name="test-map">
    <hot-restart enabled="true">
      <fsync>>false</fsync>
    </hot-restart>
  </map>
  ...
</hazelcast>

```

### Achieving High Consistency of Backup Data

The backup is initiated nearly simultaneously on all members but you can encounter some inconsistencies in the data. This is because some members might have and some might not have received updated values yet from executed operations, because the system could be undergoing partition and membership changes or because there are some transactions which have not yet been committed.

To achieve a high consistency of data on all members, the cluster should be put to **PASSIVE** state for the duration of the call to the backup method. See the [Cluster Member States](#) section on information on how to do this. The cluster does not need to be in **PASSIVE** state for the entire duration of the backup process, though. Because of the design, only partition metadata is copied synchronously during the invocation of the backup method. Once the backup method has returned all cluster metadata has been copied and the exact partition data which needs to be copied will have been marked. After that, the backup process continues asynchronously and you can return the cluster to the **ACTIVE** state and resume operations.

### Achieving High Performance of Backup Process

Because of the design of Hot Restart Store, we can use hard links to achieve backups/snapshots of the store. The hot backup process will use hard links whenever possible because they provide big performance benefits and because the backups share disk usage.

The performance benefit comes from the fact that Hot Restart file contents are not being duplicated (thus using disk and IO resources) but rather a new file name is created for the same contents on disk (another pointer to the same inode). Since all backups and stores share the same inode, disk usage drops.

The bigger the percentage of stable data in the Hot Restart Store (data not undergoing changes), the more files will each backup share with the operational Hot Restart Store and the less disk space it will be using. For the hot backup to use hard links, you must be running Hazelcast members on JDK

7 or higher and must satisfy all requirements for the `Files.createLink()` method to be supported.

The backup process will initially attempt to create a new hard link and if that fails for any reason it will continue by copying the data. Subsequent backups will also attempt to use hard links.

## Backup Process Progress and Completion

Only cluster and distributed object metadata is copied synchronously during the invocation of the backup method. The rest of the Hot Restart Store containing partition data will be copied asynchronously after the method call has ended. You can track the progress by API or view it from the Management Center.

An example of how to track the progress via API is shown below:

```
HotRestartService service = instance.getCluster().getHotRestartService();
BackupTaskStatus status = service.getBackupTaskStatus();
...
```

The returned object contains local member backup status:

- the backup state (NOT\_STARTED, IN\_PROGRESS, FAILURE, SUCCESS)
- the completed count
- the total count

The completed and total count can provide you a way to track the percentage of the copied data. Currently the count defines the number of copied and total local member Hot Restart Stores (defined by `HotRestartPersistenceConfig.setParallelism()`) but this can change at a later point to provide greater resolution.

Besides tracking the Hot Restart status by API, you can view the status in the Management Center and you can inspect the on-disk files for each member. Each member creates an `inprogress` file which is created in each of the copied Hot Restart Stores. This means that the backup is currently in progress. As the backup task completes the backup operation, the file will be removed. If an error occurs during the backup task, the `inprogress` file will be renamed to `failure` and it will contain a stack trace of the exception.

## Backup Task Interruption and Cancellation

Once the backup method call has returned and asynchronous copying of the partition data has started, the backup task can be interrupted. This is helpful in situations where the backup task has started at an inconvenient time. For instance, the backup task could be automatized and it could be accidentally triggered during high load on the Hazelcast instances, causing the performance of the Hazelcast instances to drop.

The backup task mainly uses disk IO, consumes little CPU and it generally does not last for a long time (although you should test it with your environment to determine the exact impact). Nevertheless, you can abort the backup tasks on all members via a cluster-wide interrupt operation. This operation can be triggered programmatically or from the Management Center.

An example of programmatic interruption is shown below:

```
HotRestartService service = instance.getCluster().getHotRestartService();
service.interruptBackupTask();
...
```

This method will send an interrupt to all members. The interrupt is ignored if the backup task is currently not in progress so you can safely call this method even though it has previously been called or when some members have already completed their local backup tasks.

You can also interrupt the local member backup task as shown below:

```
HotRestartService service = instance.getCluster().getHotRestartService();
service.interruptLocalBackupTask();
...
```

The backup task will stop as soon as possible and it will not remove the disk contents of the backup directory meaning that you must remove it manually.

## 15.4. Hazelcast Striim Hot Cache

### Hazelcast IMDG Enterprise

With Hazelcast Striim Hot Cache, you can reduce the latency of propagation of data from your backend database into your Hazelcast cache to milliseconds. You have the flexibility to run multiple applications off a single database, keeping Hazelcast cache refreshes current while adhering to low latency SLAs.

This joint solution with Hazelcast's in-memory data grid uses Striim's Change Data Capture (CDC) to solve the cache consistency problems.

When you have an application that needs to retrieve and store information in a database, you can use a Hazelcast in-memory cache for rapid access to data. There may be some other applications that make database updates; in this case, your application may show out-of-date or invalid information.

Hazelcast Striim Hot Cache solves this by using streaming CDC to synchronize the cache with the database in real time. This ensures that both the cache and your application always have the most current data.

Through CDC, Striim is able to recognize which tables and key values have changed. It immediately captures these changes with their table and key, and pushes the changes into the cache using the Hazelcast Striim writer.

To learn more, please see the [full press release](#), visit the Hazelcast Striim Hot Cache [product page](#), or download a fully loaded evaluation copy of [Striim for Hazelcast Hot Cache](#).

# 16. Hazelcast Clients

This chapter provides information about Hazelcast's client and language implementations, which are listed below:

- Java
- C++
- .NET
- Memcache
- REST
- Node.js
- Go
- Python
- Scala

## Feature Comparison for Hazelcast Clients:

Please refer to [Feature Comparison Matrix](#) to see the features implemented across the clients and language APIs.

## Sample Codes for Clients:

Please refer to [Client Code Samples](#).

## 16.1. Java Client

The Java client is the most full featured Hazelcast native client. It is offered both with Hazelcast IMDG and Hazelcast IMDG Enterprise. The main idea behind the Java client is to provide the same Hazelcast functionality by proxying each operation through a Hazelcast member. It can access and change distributed data and it can listen to distributed events of an already established Hazelcast cluster from another Java application.

Hundreds or even thousands of clients can be connected to the cluster. By default, there are `core count * 20` threads on the server side that will handle all the requests, e.g., if the server has 4 cores, there will be 40 threads.

Imagine a trading application where all the trading data are stored and managed in a Hazelcast cluster with tens of members. Swing/Web applications at the traders' desktops can use clients to access and modify the data in the Hazelcast cluster.



Starting with Hazelcast 3.5, a new Java Native Client Library is introduced in the release package. This library contains clients which use the new Hazelcast Open Binary Client Protocol.



- For 3.5.x releases: You can use the new client experimentally with the library `hazelcast-client-new`. This library does not exist for the releases before 3.5. Please do not use this library with the Hazelcast clusters from 3.6.x and higher releases since it is not compatible with those releases.
- For 3.6.x releases: You can use the new client with the library `hazelcast-client`. The old client's library is `hazelcast-client-legacy` and you can still use it.
- For 3.7.x and newer releases: There is no more old client for these releases. The only one is the `hazelcast-client` library, which includes clients implemented with the Hazelcast Open Binary Client Protocol.

### 16.1.1. Getting Started with Java Client



You do not need to set a license key for your Java clients for which you want to use Hazelcast IMDG Enterprise features. Hazelcast IMDG Enterprise license keys are required only for members.

You should include two dependencies in your classpath to start using the Hazelcast client: `hazelcast.jar` and `hazelcast-client.jar`.

After adding these dependencies, you can start using the Hazelcast client as if you are using the Hazelcast API. The differences are discussed in the below sections.

If you prefer to use maven, add the following lines to your `pom.xml`.

```
<dependency>
  <groupId>com.hazelcast</groupId>
  <artifactId>hazelcast-client</artifactId>
  <version>${LATEST_VERSION}</version>
</dependency>
<dependency>
  <groupId>com.hazelcast</groupId>
  <artifactId>hazelcast</artifactId>
  <version>${LATEST_VERSION}</version>
</dependency>
```

#### Client API

The first step is configuration. You can configure the Java client declaratively or programmatically. We will use the programmatic approach throughout this tutorial. Please refer to the [Java Client Declarative Configuration section](#) for details.

```
ClientConfig clientConfig = new ClientConfig();
clientConfig.getGroupConfig().setName("dev");
clientConfig.getNetworkConfig().addAddress("10.90.0.1", "10.90.0.2:5702");
```

The second step is to initialize the HazelcastInstance to be connected to the cluster.

```
HazelcastInstance client = HazelcastClient.newHazelcastClient(clientConfig);
```

**This client interface is your gateway to access all Hazelcast distributed objects.**

Let's create a map and populate it with some data.

```
IMap<String, Customer> mapCustomers = client.getMap("customers"); //creates the map
proxy

mapCustomers.put("1", new Customer("Joe", "Smith"));
mapCustomers.put("2", new Customer("Ali", "Selam"));
mapCustomers.put("3", new Customer("Avi", "Noyan"));
```

As a final step, if you are done with your client, you can shut it down as shown below. This will release all the used resources and will close connections to the cluster.

```
client.shutdown();
```

## Java Client Operation Modes

The client has two operation modes because of the distributed nature of the data and cluster.

**Smart Client:** In smart mode, clients connect to each cluster member. Since each data partition uses the well known and consistent hashing algorithm, each client can send an operation to the relevant cluster member, which increases the overall throughput and efficiency. Smart mode is the default mode.

**Unisocket Client:** For some cases, the clients can be required to connect to a single member instead of to each member in the cluster. Firewalls, security, or some custom networking issues can be the reason for these cases.

In unisocket client mode, the client will only connect to one of the configured addresses. This single member will behave as a gateway to the other members. For any operation requested from the client, it will redirect the request to the relevant member and return the response back to the client returned from this member.

## Handling Failures

There are two main failure cases and configurations you can perform to achieve proper behavior.

## Handling Client Connection Failure:

While the client is trying to connect initially to one of the members in the `ClientNetworkConfig.addressList`, all the members might be not available. Instead of giving up, throwing an exception and stopping the client, the client will retry as many as `connectionAttemptLimit` times.

You can configure `connectionAttemptLimit` for the number of times you want the client to retry connecting. Please see [Setting Connection Attempt Limit](#).

The client executes each operation through the already established connection to the cluster. If this connection(s) disconnects or drops, the client will try to reconnect as configured.

## Handling Retry-able Operation Failure:

While sending the requests to related members, operations can fail due to various reasons. Read-only operations are retried by default. If you want to enable retry for the other operations, you can set the `redoOperation` to `true`. Please see [Enabling Redo Operation](#).

You can set a timeout for retrying the operations sent to a member. This can be provided by using the property `hazelcast.client.invocation.timeout.seconds` in `ClientProperties`. The client will retry an operation within this given period, of course, if it is a read-only operation or you enabled the `redoOperation` as stated in the above paragraph. This timeout value is important when there is a failure resulted by either of the following causes:

- Member throws an exception.
- Connection between the client and member is closed.
- Client's heartbeat requests are timed out.

Please see the [Client System Properties section](#) for the description of the property `hazelcast.client.invocation.timeout.seconds`.

When any failure happens between a client and member (such as an exception at the member side, connection issues, etc.), an operation is retried if:

- it is certain that it has not run on the member yet, or
- if it is idempotent such as a read-only operation, i.e., retrying does not have a side effect.

If it is not certain whether the operation has run on the member, then the non-idempotent operations are not retried. However, as explained in the first paragraph of this section, you can force all client operations to be retried (`redoOperation`) when there is a failure between the client and member. But in this case, you should know that some operations may run multiple times causing conflicts. For example, assume that your client sent a `queue.offer` operation to the member and then the connection is lost. Since there will be no respond for this operation, you will not know whether it has run on the member or not. If you enabled `redoOperation`, that `queue.offer` operation may rerun and this will cause the same objects to be offered twice in the member's queue.

## Using Supported Distributed Data Structures

Most of the Distributed Data Structures are supported by the Java client. When you use clients in other languages, you should check for the exceptions.

As a general rule, you configure these data structures on the server side and access them through a proxy on the client side.

### Using Map with Java Client

You can use any [Distributed Map](#) object with the client, as shown below.

```
Imap<Integer, String> map = client.getMap("myMap");  
  
map.put(1, "Ali");  
String value= map.get(1);  
map.remove(1);
```

Locality is ambiguous for the client, so `addLocalEntryListener` and `localKeySet` are not supported. Please see the [Distributed Map section](#) for more information.

### Using MultiMap with Java Client

A MultiMap usage example is shown below.

```
MultiMap<Integer, String> multiMap = client.getMultiMap("myMultiMap");  
  
multiMap.put(1,"ali");  
multiMap.put(1,"veli");  
  
Collection<String> values = multiMap.get(1);
```

`addLocalEntryListener`, `localKeySet` and `getLocalMultiMapStats` are not supported because locality is ambiguous for the client. Please see the [Distributed MultiMap section](#) for more information.

### Using Queue with Java Client

A sample usage is shown below.

```
IQueue<String> myQueue = client.getQueue("theQueue");  
myQueue.offer("ali")
```

`getLocalQueueStats` is not supported because locality is ambiguous for the client. Please see the [Distributed Queue section](#) for more information.

### Using Topic with Java Client

`getLocalTopicStats` is not supported because locality is ambiguous for the client.

## Using Other Supported Distributed Structures

The distributed data structures listed below are also supported by the client. Since their logic is the same in both the member side and client side, you can refer to their sections as listed below.

- [Replicated Map](#)
- [MapReduce](#)
- [List](#)
- [Set](#)
- [IAtomicLong](#)
- [IAtomicReference](#)
- [ICountDownLatch](#)
- [ISemaphore](#)
- [IdGenerator](#)
- [FlakeIdGenerator](#)
- [Lock](#)

## Using Client Services

Hazelcast provides the services discussed below for some common functionalities on the client side.

### Using Distributed Executor Service

The distributed executor service is for distributed computing. It can be used to execute tasks on the cluster on a designated partition or on all the partitions. It can also be used to process entries. Please see the [Distributed Executor Service section](#) for more information.

```
IExecutorService executorService = client.getExecutorService("default");
```

After getting an instance of `IExecutorService`, you can use the instance as the interface with the one provided on the server side. Please see the [Distributed Computing chapter](#) for detailed usage.



This service is only supported by the Java client.

### Listening to Client Connection

If you need to track clients and you want to listen to their connection events, you can use the `clientConnected` and `clientDisconnected` methods of the `ClientService` class. This class must be run on the **member** side. The following is an example code.

```

ClientConfig clientConfig = new ClientConfig();
clientConfig.getGroupConfig().setName("dev");
clientConfig.getNetworkConfig().addAddress("10.90.0.1", "10.90.0.2:5702");

HazelcastInstance instance = Hazelcast.newHazelcastInstance();

final ClientService clientService = instance.getClientService();

clientService.addClientListener(new ClientListener() {
    @Override
    public void clientConnected(Client client) {
        //Handle client connected event
    }

    @Override
    public void clientDisconnected(Client client) {
        //Handle client disconnected event
    }
});

//this will trigger `clientConnected` event
HazelcastInstance client = HazelcastClient.newHazelcastClient();

final Collection<Client> connectedClients = clientService.getConnectedClients();

//this will trigger `clientDisconnected` event
client.shutdown();

```

### Finding the Partition of a Key

You use partition service to find the partition of a key. It will return all partitions. See the example code below.

```

PartitionService partitionService = client.getPartitionService();

//partition of a key
Partition partition = partitionService.getPartition(key);

//all partitions
Set<Partition> partitions = partitionService.getPartitions();

```

### Handling Lifecycle

Lifecycle handling performs the following:

- Check if the client is running.
- Shut down the client gracefully.
- Terminate the client ungracefully (forced shutdown).

- Add/remove lifecycle listeners.

```
LifecycleService lifecycleService = client.getLifecycleService();

if(lifecycleService.isRunning()){
    //it is running
}

//shutdown client gracefully
lifecycleService.shutdown();
```

## Client Listeners

You can configure listeners to listen to various event types on the client side. You can configure global events not relating to any distributed object through [Client ListenerConfig](#). You should configure distributed object listeners like map entry listeners or list item listeners through their proxies. You can refer to the related sections under each distributed data structure in this reference manual.

## Client Transactions

Transactional distributed objects are supported on the client side. Please see the [Transactions chapter](#) on how to use them.

## Async Start and Reconnect Modes

Java client can be configured to connect to a cluster in an async manner during the client start and reconnecting after a cluster disconnect. Both of these options are configured via [ClientConnectionStrategyConfig](#).

Async client start is configured by setting the configuration element `async-start` to `true`. This configuration will change the behavior of `HazelcastClient.newHazelcastClient()` call. It'll return a client instance without waiting to establish a cluster connection. Until the client connects to cluster, it will throw `HazelcastClientOfflineException` on any network dependent operations hence they won't block. If you want to check or wait the client to complete its cluster connection, you can use the built-in lifecycle listener:

```

ClientStateListener clientStateListener = new ClientStateListener(clientConfig);
HazelcastInstance client = HazelcastClient.newHazelcastClient(clientConfig);

//Client started but may not be connected to cluster yet.

//check connection status
clientStateListener.isConnected();

//blocks until client completes connect to cluster
if (clientStateListener.awaitConnected()) {
    //connected successfully
} else {
    //client failed to connect to cluster
}

```

Java client can also be configured to specify how it reconnects after a cluster disconnection. There are three options:

- A client can reject to reconnect to the cluster and trigger the client shutdown process.
- Client can open a connection to the cluster by blocking all waiting invocations.
- Client can open a connection to the cluster without blocking the waiting invocations. All invocations will receive `HazelcastClientOfflineException` during the establishment of cluster connection. If cluster connection is failed to connect, then client shutdown will be triggered.

You can refer to the [Configuring Client Connection Strategy section](#) to learn how to configure these.

### 16.1.2. Configuring Java Client

You can configure Hazelcast Java Client declaratively (XML), programmatically (API), or using client system properties.

For declarative configuration, the Hazelcast client looks at the following places for the client configuration file.

- **System property:** The client first checks if `hazelcast.client.config` system property is set to a file path, e.g., `-Dhazelcast.client.config=C:/myhazelcast.xml`.
- **Classpath:** If config file is not set as a system property, the client checks the classpath for `hazelcast-client.xml` file.

If the client does not find any configuration file, it starts with the default configuration (`hazelcast-client-default.xml`) located in the `hazelcast-client.jar` library. Before configuring the client, please try to work with the default configuration to see if it works for you. The default should be just fine for most users. If not, then consider custom configuration for your environment.

If you want to specify your own configuration file to create a `Config` object, the Hazelcast client supports the following.

- `Config cfg = new XmlClientConfigBuilder(xmlFileName).build();`



- `Config cfg = new XmlClientConfigBuilder(inputStream).build();`

For programmatic configuration of the Hazelcast Java Client, just instantiate a `ClientConfig` object and configure the desired aspects. An example is shown below.

```
ClientConfig clientConfig = new ClientConfig();
clientConfig.setGroupConfig(new GroupConfig("dev", "dev-pass"));
clientConfig.setLoadBalancer(yourLoadBalancer);
...
...
```

## Client Network

All network related configuration of Hazelcast Java Client is performed via the `network` element in the declarative configuration file, or in the class `ClientNetworkConfig` when using programmatic configuration. Let's first give the examples for these two approaches. Then we will look at its sub-elements and attributes.

### Declarative Client Network Configuration

Here is an example of configuring network for Java Client declaratively.

```

<hazelcast-client xsi:schemaLocation=
  "http://www.hazelcast.com/schema/client-config hazelcast-client-config-<version
>.xsd"
  xmlns="http://www.hazelcast.com/schema/client-config"
  xmlns:xsi="http://www.w3.org/2001/XMLSchema-instance">
...
<network>
  <cluster-members>
    <address>127.0.0.1</address>
    <address>127.0.0.2</address>
  </cluster-members>
  <outbound-ports>
    <ports>34600</ports>
    <ports>34700-34710</ports>
  </outbound-ports>
  <smart-routing>true</smart-routing>
  <redo-operation>true</redo-operation>
  <socket-interceptor enabled="true">
    <class-name>com.hazelcast.XYZ</class-name>
    <properties>
      <property name="kerberos-host">kerb-host-name</property>
      <property name="kerberos-config-file">kerb.conf</property>
    </properties>
  </socket-interceptor>
  <aws enabled="true" connection-timeout-seconds="11">
    <inside-aws>false</inside-aws>
    <access-key>my-access-key</access-key>
    <secret-key>my-secret-key</secret-key>
    <iam-role>s3access</iam-role>
    <region>us-west-1</region>
    <host-header>ec2.amazonaws.com</host-header>
    <security-group-name>hazelcast-sg</security-group-name>
    <tag-key>type</tag-key>
    <tag-value>hz-members</tag-value>
  </aws>
</network>

```

### Programmatic Client Network Configuration

Here is an example of configuring network for Java Client programmatically.

```

ClientConfig clientConfig = new ClientConfig();
ClientNetworkConfig networkConfig = clientConfig.getNetworkConfig();
networkConfig.addAddress("10.1.1.21", "10.1.1.22:5703")
    .setSmartRouting(true)
    .addOutboundPortDefinition("34700-34710")
    .setRedoOperation(true)
    .setConnectionTimeout(5000)
    .setConnectionAttemptLimit(5);

ClientAwsConfig clientAwsConfig = new ClientAwsConfig();
clientAwsConfig.setInsideAws( false )
    .setAccessKey( "my-access-key" )
    .setSecretKey( "my-secret-key" )
    .setRegion( "us-west-1" )
    .setHostHeader( "ec2.amazonaws.com" )
    .setSecurityGroupName( ">hazelcast-sg" )
    .setTagKey( "type" )
    .setTagValue( "hz-members" )
    .setIamRole( "s3access" )
    .setEnabled( true );
clientConfig.getNetworkConfig().setAwsConfig( clientAwsConfig );
HazelcastInstance client = HazelcastClient.newHazelcastClient(clientConfig);

```

### Configuring Address List

Address List is the initial list of cluster addresses to which the client will connect. The client uses this list to find an alive member. Although it may be enough to give only one address of a member in the cluster (since all members communicate with each other), it is recommended that you give the addresses for all the members.

### Declarative:

```

<hazelcast-client>
  ...
  <network>
    <cluster-members>
      <address>10.1.1.21</address>
      <address>10.1.1.22:5703</address>
    </cluster-members>
  ...
</network>
...
</hazelcast-client>

```

### Programmatic:

```
ClientConfig clientConfig = new ClientConfig();
ClientNetworkConfig networkConfig = clientConfig.getNetworkConfig();
networkConfig.addAddress("10.1.1.21", "10.1.1.22:5703");
```

If the port part is omitted, then 5701, 5702 and 5703 will be tried in random order.

You can provide multiple addresses with ports provided or not, as seen above. The provided list is shuffled and tried in random order. Its default value is **localhost**.



If you have multiple members on a single machine and you are using [unisolet clients](#), we recommend you to set explicit [ports](#) for each member. Then you should provide those ports in your client configuration when you give the member addresses (using the [address](#) configuration element or [addAddress](#) method as exemplified above). Otherwise, all the load coming from your clients may go through a single member.

### Setting Outbound Ports

You may want to restrict outbound ports to be used by Hazelcast-enabled applications. To fulfill this requirement, you can configure Hazelcast Java client to use only defined outbound ports. The following are example configurations.

#### Declarative:

```
<network>
  <outbound-ports>
    <!-- ports between 34700 and 34710 -->
    <ports>34700-34710</ports>
    <!-- comma separated ports -->
    <ports>34700,34701,34702,34703</ports>
    <ports>34700,34705-34710</ports>
  </outbound-ports>
</network>
```

#### Programmatic:

```
...
NetworkConfig networkConfig = config.getNetworkConfig();
// ports between 34700 and 34710
networkConfig.addOutboundPortDefinition("34700-34710");
// comma separated ports
networkConfig.addOutboundPortDefinition("34700,34701,34702,34703");
networkConfig.addOutboundPort(34705);
...
```



You can use port ranges and/or comma separated ports.

As shown in the programmatic configuration, you use the method `addOutboundPort` to add only one port. If you need to add a group of ports, then use the method `addOutboundPortDefinition`.

In the declarative configuration, the element `ports` can be used for both single and multiple port definitions.

### Setting Smart Routing

Smart routing defines whether the client operation mode is smart or unisocket. See [Java Client Operation Modes](#) to learn about these modes.

The following are example configurations.

#### Declarative:

```
...
<network>
...
  <smart-routing>true</smart-routing>
...
</network>
...
```

#### Programmatic:

```
ClientConfig clientConfig = new ClientConfig();
ClientNetworkConfig networkConfig = clientConfig.getNetworkConfig();
networkConfig.setSmartRouting(true);
```

Its default value is `true` (smart client mode).

Note that you need to disable smart routing (`false`) for the clients which want to use temporary permissions defined in a member. See the [Handling Permissions section](#).

### Enabling Redo Operation

It enables/disables redo-able operations as described in [Handling Retry-able Operation Failure](#). The following are the example configurations.

#### Declarative:

```
...
<network>
...
  <redo-operation>true</redo-operation>
...
</network>
```

## Programmatic:

```
ClientConfig clientConfig = new ClientConfig();
ClientNetworkConfig networkConfig = clientConfig.getNetworkConfig();
networkConfig().setRedoOperation(true);
```

Its default value is `false` (disabled).

## Setting Connection Timeout

Connection timeout is the timeout value in milliseconds for members to accept client connection requests. The following are the example configurations.

## Declarative:

```
...
<network>
...
  <connection-timeout>5000</connection-timeout>
...
</network>
```

## Programmatic:

```
ClientConfig clientConfig = new ClientConfig();
clientConfig.getNetworkConfig().setConnectionTimeout(5000);
```

Its default value is `5000` milliseconds.

## Setting Connection Attempt Limit

While the client is trying to connect initially to one of the members in the `ClientNetworkConfig.addressList`, that member might not be available at that moment. Instead of giving up, throwing an exception and stopping the client, the client will retry as many as `ClientNetworkConfig.connectionAttemptLimit` times. This is also the case when the previously established connection between the client and that member goes down. The following are example configurations.

## Declarative:

```
...
<network>
...
  <connection-attempt-limit>5</connection-attempt-limit>
...
</network>
```

## Programmatic:

```
ClientConfig clientConfig = new ClientConfig();
clientConfig.getNetworkConfig().setConnectionAttemptLimit(5);
```

Its default value is 2.

### Setting Connection Attempt Period

Connection attempt period is the duration in milliseconds between the connection attempts defined by `ClientNetworkConfig.connectionAttemptLimit`. The following are example configurations.

## Declarative:

```
...
<network>
...
  <connection-attempt-period>5000</connection-attempt-period>
...
</network>
```

## Programmatic:

```
ClientConfig clientConfig = new ClientConfig();
clientConfig.getNetworkConfig().setConnectionAttemptPeriod(5000);
```

Its default value is **3000** milliseconds.

### Setting a Socket Interceptor

#### Hazelcast IMDG Enterprise

Following is a client configuration to set a socket interceptor. Any class implementing `com.hazelcast.nio.SocketInterceptor` is a socket interceptor.

```
public interface SocketInterceptor {
    void init(Properties properties);
    void onConnect(Socket connectedSocket) throws IOException;
}
```

`SocketInterceptor` has two steps. First, it will be initialized by the configured properties. Second, it will be informed just after the socket is connected using `onConnect`.

```

SocketInterceptorConfig socketInterceptorConfig = clientConfig
    .getNetworkConfig().getSocketInterceptorConfig();

MyClientSocketInterceptor myClientSocketInterceptor = new MyClientSocketInterceptor();

socketInterceptorConfig.setEnabled(true);
socketInterceptorConfig.setImplementation(myClientSocketInterceptor);

```

If you want to configure the socket interceptor with a class name instead of an instance, see the example below.

```

SocketInterceptorConfig socketInterceptorConfig = clientConfig
    .getNetworkConfig().getSocketInterceptorConfig();

MyClientSocketInterceptor myClientSocketInterceptor = new MyClientSocketInterceptor();

socketInterceptorConfig.setEnabled(true);

//These properties are provided to interceptor during init
socketInterceptorConfig.setProperty("kerberos-host", "kerb-host-name");
socketInterceptorConfig.setProperty("kerberos-config-file", "kerb.conf");

socketInterceptorConfig.setClassName(MyClientSocketInterceptor.class.getName());

```



Please see the [Socket Interceptor section](#) for more information.

### Configuring Network Socket Options

You can configure the network socket options using `SocketOptions`. It has the following methods.

- `socketOptions.setKeepAlive(x)`: Enables/disables the `SO_KEEPALIVE` socket option. Its default value is `true`.
- `socketOptions.setTcpNoDelay(x)`: Enables/disables the `TCP_NODELAY` socket option. Its default value is `true`.
- `socketOptions.setReuseAddress(x)`: Enables/disables the `SO_REUSEADDR` socket option. Its default value is `true`.
- `socketOptions.setLingerSeconds(x)`: Enables/disables `SO_LINGER` with the specified linger time in seconds. Its default value is `3`.
- `socketOptions.setBufferSize(x)`: Sets the `SO_SNDBUF` and `SO_RCVBUF` options to the specified value in KB for this Socket. Its default value is `32`.



```
SocketOptions socketOptions = clientConfig.getNetworkConfig().getSocketOptions();
socketOptions.setBufferSize(32);
socketOptions.setKeepAlive(true);
socketOptions.setTcpNoDelay(true);
socketOptions.setReuseAddress(true);
socketOptions.setLingerSeconds(3);
```

## Enabling Client TLS/SSL

### Hazelcast IMDG Enterprise

You can use TLS/SSL to secure the connection between the client and the members. If you want TLS/SSL enabled for the client-cluster connection, you should set `SSLConfig`. Once set, the connection (socket) is established out of an TLS/SSL factory defined either by a factory class name or factory implementation. Please see the [TLS/SSL section](#).

As explained in the [TLS/SSL section](#), Hazelcast members have `keyStores` used to identify themselves (to other members) and Hazelcast clients have `trustStore` used to define which members they can trust. Starting with Hazelcast 3.8.1 release, mutual authentication is introduced. This allows the clients also to have their `keyStores` and members to have their `trustStores` so that the members can know which clients they can trust. Please see the [Mutual Authentication section](#).

## Configuring Client for AWS

The example declarative and programmatic configurations below show how to configure a Java client for connecting to a Hazelcast cluster in AWS.

### Declarative:

```
...
<network>
  <aws enabled="true">
    <inside-aws>false</inside-aws>
    <access-key>my-access-key</access-key>
    <secret-key>my-secret-key</secret-key>
    <iam-role>s3access</iam-role>
    <region>us-west-1</region>
    <host-header>ec2.amazonaws.com</host-header>
    <security-group-name>hazelcast-sg</security-group-name>
    <tag-key>type</tag-key>
    <tag-value>hz-members</tag-value>
  </aws>
...
</network>
```

### Programmatic:

```

ClientConfig clientConfig = new ClientConfig();
ClientAwsConfig clientAwsConfig = new ClientAwsConfig();
clientAwsConfig.setInsideAws( false )
    .setAccessKey( "my-access-key" )
    .setSecretKey( "my-secret-key" )
    .setRegion( "us-west-1" )
    .setHostHeader( "ec2.amazonaws.com" )
    .setSecurityGroupName( ">hazelcast-sg" )
    .setTagKey( "type" )
    .setTagValue( "hz-members" )
    .setIamRole( "s3access" )
    .setEnabled( true );
clientConfig.getNetworkConfig().setAwsConfig( clientAwsConfig );
HazelcastInstance client = HazelcastClient.newHazelcastClient(clientConfig);

```

You can refer to the [aws element section](#) for the descriptions of above AWS configuration elements except `inside-aws` and `iam-role`, which are explained below.

If the `inside-aws` element is not set, the private addresses of cluster members will always be converted to public addresses. Also, the client will use public addresses to connect to the members. In order to use private addresses, set the `inside-aws` parameter to `true`. Also note that, when connecting outside from AWS, setting the `inside-aws` parameter to `true` will cause the client to not be able to reach the members.

IAM roles are used to make secure requests from your clients. You can provide the name of your IAM role that you created previously on your AWS console using the `iam-role` or `setIamRole()` method.

## Configuring Client Load Balancer

`LoadBalancer` allows you to send operations to one of a number of endpoints (Members). Its main purpose is to determine the next `Member` if queried. It is up to your implementation to use different load balancing policies. You should implement the interface `com.hazelcast.client.LoadBalancer` for that purpose.

If the client is configured in smart mode, only the operations that are not key-based will be routed to the endpoint that is returned by the `LoadBalancer`. If the client is not a smart client, `LoadBalancer` will be ignored.

The following are example configurations.

### Declarative:

```
<hazelcast-client>
...
<load-balancer type="random">
  yourLoadBalancer
</load-balancer>
...
</hazelcast-client>
```

### Programmatic:

```
ClientConfig clientConfig = new ClientConfig();
clientConfig.setLoadBalancer(yourLoadBalancer);
```

### Configuring Client Listeners

You can configure global event listeners using `ListenerConfig` as shown below.

```
ClientConfig clientConfig = new ClientConfig();
ListenerConfig listenerConfig = new ListenerConfig(LifecycleListenerImpl);
clientConfig.addListenerConfig(listenerConfig);
```

```
ClientConfig clientConfig = new ClientConfig();
ListenerConfig listenerConfig = new ListenerConfig(
    "com.hazelcast.example.MembershipListenerImpl");
clientConfig.addListenerConfig(listenerConfig);
```

You can add three types of event listeners.

- `LifecycleListener`
- `MembershipListener`
- `DistributedObjectListener`

### Configuring Client Connection Strategy

You can configure the client's starting mode as `async` or `sync` using the configuration element `async-start`. When it is set to `true` (async), Hazelcast will create the client without waiting a connection to the cluster. In this case, the client instance throws an exception until it connects to the cluster. If it is `false`, the client will not be created until the cluster is ready to use clients and a connection with the cluster is established. Its default value is `false` (sync)

You can also configure how the client will reconnect to the cluster after a disconnection. This is configured using the configuration element `reconnect-mode`; it has three options (`OFF`, `ON` or `ASYNC`). The option `OFF` disables the reconnection. `ON` enables reconnection in a blocking manner where all the waiting invocations will be blocked until a cluster connection is established or failed. The option `ASYNC` enables reconnection in a non-blocking manner where all the waiting invocations will

receive a `HazelcastClientOfflineException`. Its default value is `ON`.

The example declarative and programmatic configurations below show how to configure a Java client's starting and reconnecting modes.

#### Declarative:

```
<hazelcast-client>
  ...
  <connection-strategy async-start="true" reconnect-mode="ASYNC" />
  ...
</hazelcast-client>
```

#### Programmatic:

```
ClientConfig clientConfig = new ClientConfig();
clientConfig.getConnectionStrategyConfig()
    .setAsyncStart(true)
    .setReconnectMode(ClientConnectionStrategyConfig.ReconnectMode.ASYNC);
```

### Configuring Client Connection Retry

When the client tries to connect to a cluster, it considers the `connection attempt limit` and `connection attempt period`. When the client cannot connect to any member in the member list, it waits for `connection-attempt-period` between each attempt until the count of attempts reach `connection-attempt-limit`.

With the connection retry configuration, you can fine tune this connection behavior. When this configuration is enabled, `connection-attempt-period` and `connection-attempt-limit` are ignored. This configuration is used when trying to establish the initial connection and any time when the connection to cluster is broken.

Connection retry configuration is done using the `connection-retry` element when configuring declaratively or the object `ConnectionRetryConfig` when configuring programmatically. Below are the example configurations for each.

#### Declarative:

```

<hazelcast-client>
...
<connection-strategy async-start="false" reconnect-mode="ON">
  <connection-retry enabled="true">
    <initial-backoff-millis>1000</initial-backoff-millis>
    <max-backoff-millis>60000</max-backoff-millis>
    <multiplier>2</multiplier>
    <fail-on-max-backoff>true</fail-on-max-backoff>
    <jitter>0.5</jitter>
  </connection-retry>
</connection-strategy>
...
</hazelcast-client>

```

### Programmatic:

```

ClientConfig config = new ClientConfig();
ClientConnectionStrategyConfig connectionStrategyConfig = config
.getConnectionStrategyConfig();
ConnectionRetryConfig connectionRetryConfig = connectionStrategyConfig
.getConnectionRetryConfig();
connectionRetryConfig.setInitialBackoffMillis(1000)
                      .setMaxBackoffMillis(60000)
                      .setMultiplier(2)
                      .setFailOnMaxBackoff(true)
                      .setJitter(0.2)
                      .setEnabled(true);

```

The following are configuration element descriptions:

- **initial-backoff-millis**: Specifies how long to wait (backoff) after the first failure before retrying in milliseconds. Its default value is 1000 ms.
- **max-backoff-millis**: Specifies the upper limit for the backoff in milliseconds. Its default value is 30000 ms.
- **multiplier**: Factor to multiply the backoff after a failed retry. Its default value is 2.
- **fail-on-max-backoff**: Specifies whether to fail when the **max-backoff-millis** has reached or continue waiting **max-backoff-millis** at each iteration. Its default value is false.
- **jitter**: Specifies by how much to randomize backoffs. Its default value is 0.2.

A pseudo-code is as follows:

```

current_backoff_millis = INITIAL_BACKOFF_MILLIS
while (TryConnect(connectionTimeout)) != SUCCESS)
    if (fail-on-max-backoff && current_backoff_millis >= MAX_BACKOFF_MILLIS) {
        FAIL WITH EXCEPTION
    }
    randomizedSleepMillis = UniformRandom(-JITTER * current_backoff_millis, JITTER *
current_backoff_millis)
    Sleep(randomizedSleepMillis)
    current_backoff = Min(current_backoff_millis * MULTIPLIER, MAX_BACKOFF_MILLIS)

```

Note that, `TryConnect` above tries to connect any member that the client knows of, and for each connection we have a connection timeout, see the [Setting Connection Timeout section](#).

## Other Configurations

### Configuring Client Near Cache

The Hazelcast distributed map supports a local Near Cache for remotely stored entries to increase the performance of local read operations. Since the client always requests data from the cluster members, it can be helpful in some use cases to configure a Near Cache on the client side. Please refer to the [Near Cache section](#) for a detailed explanation of the Near Cache feature and its configuration.

### Client Group Configuration

Clients should provide a group name and password in order to connect to the cluster. You can configure them using `GroupConfig`, as shown below.

```

clientConfig.setGroupConfig(new GroupConfig("dev", "dev-pass"));

```

### Client Security Configuration

In the cases where the security established with `GroupConfig` is not enough and you want your clients connecting securely to the cluster, you can use `ClientSecurityConfig`. This configuration has a `credentials` parameter to set the IP address and UID. Please see `ClientSecurityConfig.java` in our code.

### Client Serialization Configuration

For the client side serialization, use Hazelcast configuration. Please refer to the [Serialization chapter](#).

### ExecutorPoolSize

Hazelcast has an internal executor service (different from the data structure **Executor Service**) that has threads and queues to perform internal operations such as handling responses. This parameter specifies the size of the pool of threads which perform these operations laying in the executor's queue. If not configured, this parameter has the value as `5 * core size of the client` (i.e.

it is 20 for a machine that has 4 cores).

## ClassLoader

You can configure a custom `ClassLoader`. It will be used by the serialization service and to load any class configured in configuration, such as event listeners or `ProxyFactories`.

## Configuring Reliable Topic at Client Side

Normally when a client uses a Hazelcast data structure, that structure is configured at the member side and the client makes use of that configuration. For the Reliable Topic structure, this is not the case; since it is backed by Ringbuffer, you should configure it at the client side. The class used for this configuration is `ClientReliableTopicConfig`.

Here is an example programmatic configuration snippet:

```
Config config = new Config();
RingbufferConfig ringbufferConfig = new RingbufferConfig("default");
ringbufferConfig.setCapacity(10000000)
    .setTimeToLiveSeconds(5);
config.addRingBufferConfig(ringbufferConfig);

ClientConfig clientConfig = new ClientConfig();
ClientReliableTopicConfig topicConfig = new ClientReliableTopicConfig("default");
clientConfig.addReliableTopicConfig(topicConfig);

HazelcastInstance hz = Hazelcast.newHazelcastInstance(config);
HazelcastInstance client = HazelcastClient.newHazelcastClient(clientConfig);
ITopic topic = client.getReliableTopic(topicConfig.getName());
```

Note that, when you create a Reliable Topic structure at your client, a Ringbuffer (with the same name as the Reliable Topic) is automatically created at the member side, with its default configuration. Please see the [Configuring Ringbuffer section](#) for the defaults. You can edit that configuration according to your needs.

### 16.1.3. Java Client Failure Detectors

The client failure detectors are responsible to determine if a member in the cluster is unreachable or crashed. The most important problem in the failure detection is to distinguish whether a member is still alive but slow, or has crashed. But according to the famous [FLP result](#), it is impossible to distinguish a crashed member from a slow one in an asynchronous system. A workaround to this limitation is to use unreliable failure detectors. An unreliable failure detector allows a member to suspect that others have failed, usually based on liveness criteria but it can make mistakes to a certain degree.

Hazelcast Java client has two built-in failure detectors: Deadline Failure Detector and Ping Failure Detector. These client failure detectors work independently from the member failure detectors, e.g., you do not need to enable the member failure detectors to benefit from the client ones.

## Client Deadline Failure Detector

*Deadline Failure Detector* uses an absolute timeout for missing/lost heartbeats. After timeout, a member is considered as crashed/unavailable and marked as suspected.

*Deadline Failure Detector* has two configuration properties:

- `hazelcast.client.heartbeat.interval`: This is the interval at which client sends heartbeat messages to members.
- `hazelcast.client.heartbeat.timeout`: This is the timeout which defines when a cluster member is suspected, because it has not sent any response back to client requests.



The value of `hazelcast.client.heartbeat.interval` should be smaller than that of `hazelcast.client.heartbeat.timeout`. In addition, the value of system property `hazelcast.client.max.no.heartbeat.seconds`, which is set at the member side, should be larger than that of `hazelcast.client.heartbeat.interval`.

The following is a declarative example showing how you can configure the Deadline Failure Detector for your client (in the client's configuration XML file, e.g., `hazelcast-client.xml`):

```
<hazelcast-client>
  [...]
  <properties>
    <property name="hazelcast.client.heartbeat.timeout">60000</property>
    <property name="hazelcast.client.heartbeat.interval">5000</property>
    [...]
  </properties>
  [...]
</hazelcast-client>
```

And, the following is the equivalent programmatic configuration:

```
ClientConfig config = ...;
config.setProperty("hazelcast.client.heartbeat.timeout", "60000");
config.setProperty("hazelcast.client.heartbeat.interval", "5000");
[...]
```

## Client Ping Failure Detector

In addition to the Deadline Failure Detector, the Ping Failure Detector may be configured on your client. Please note that this detector is disabled by default. The Ping Failure Detector operates at Layer 3 of the OSI protocol and provides much quicker and more deterministic detection of hardware and other lower level events. When the JVM process has enough permissions to create RAW sockets, the implementation will choose to rely on ICMP Echo requests. This is preferred.

If there are not enough permissions, it can be configured to fallback on attempting a TCP Echo on port 7. In the latter case, both a successful connection or an explicit rejection will be treated as



"Host is Reachable". Or, it can be forced to use only RAW sockets. This is not preferred as each call creates a heavy weight socket and moreover the Echo service is typically disabled.

For the Ping Failure Detector to rely **only** on ICMP Echo requests, there are some criteria that need to be met:

- Supported OS: as of Java 1.8 only Linux/Unix environments are supported.
- The Java executable must have the `cap_net_raw` capability.
- The file `ld.conf` must be edited to overcome the rejection by the dynamic linker when loading libs from untrusted paths.
- ICMP Echo Requests must not be blocked by the receiving hosts.

The details of these requirements are explained in the [Requirements section](#) of Hazelcast members' [Ping Failure Detector](#).

If any of the above criteria isn't met, then the `isReachable` will always fallback on TCP Echo attempts on port 7.

An example declarative configuration to use the Ping Failure Detector is as follows (in the client's configuration XML file, e.g., `hazelcast-client.xml`):

```
<hazelcast-client>
  [...]
  <network>
    [...]
    <icmp-ping enabled="true">
      <timeout-milliseconds>1000</timeout-milliseconds>
      <interval-milliseconds>1000</interval-milliseconds>
      <ttl>255</ttl>
      <echo-fail-fast-on-startup>false</echo-fail-fast-on-startup>
      <max-attempts>2</max-attempts>
    </icmp-ping>
    [...]
  </network>
  [...]
</hazelcast-client>
```

And, the equivalent programmatic configuration:

```

ClientConfig config = ...;

ClientNetworkConfig networkConfig = clientConfig.getNetworkConfig();
ClientIcmpPingConfig clientIcmpPingConfig = networkConfig.getClientIcmpPingConfig();
clientIcmpPingConfig.setIntervalMilliseconds(1000)
    .setTimeoutMilliseconds(1000)
    .setTtl(255)
    .setMaxAttempts(2)
    .setEchoFailFastOnStartup(false)
    .setEnabled(true);
[...]

```

- **enabled**: Enables the legacy ICMP detection mode, works cooperatively with the existing failure detector and only kicks-in after a pre-defined period has passed with no heartbeats from a member. Its default value is **false**.
- **timeout-milliseconds**: Number of milliseconds until a ping attempt is considered failed if there was no reply. Its default value is **1000** milliseconds.
- **max-attempts**: Maximum number of ping attempts before the member gets suspected by the detector. Its default value is **3**.
- **interval-milliseconds**: Interval, in milliseconds, between each ping attempt. 1000ms (1 sec) is also the minimum interval allowed. Its default value is **1000** milliseconds.
- **ttl**: Maximum number of hops the packets should go through. Its default value is **255**. You can set to **0** to use your system's default TTL.

In the above example configuration, the Ping Failure Detector will attempt 2 pings, one every second and will wait up to 1 second for each to complete. If there is no successful ping after 2 seconds, the member will get suspected.

To enforce the [Requirements](#), the property **echo-fail-fast-on-startup** can also be set to **true**, in which case Hazelcast will fail to start if any of the requirements isn't met.

Unlike the Hazelcast members, Ping Failure Detector works always in parallel with Deadline Failure Detector on the clients. Below is a summary table of all possible configuration combinations of the Ping Failure Detector.

ICMP	Fail-Fast	Description	Linux	Windows	macOS
true	false	Parallel ping detector, works in parallel with the configured failure detector. Checks periodically if members are live (OSI Layer 3) and suspects them immediately, regardless of the other detectors.	Supported ICMP Echo if available - Falls back on TCP Echo on port 7	Supported TCP Echo on port 7	Supported ICMP Echo if available - Falls back on TCP Echo on port 7
	true	true	Parallel ping detector, works in parallel with the configured failure detector. Checks periodically if members are live (OSI Layer 3) and suspects them immediately, regardless of the other detectors.	Supported - Requires OS Configuration Enforcing ICMP Echo if available - No start up if not available	Not Supported

### 16.1.4. Client System Properties

There are some advanced client configuration properties to tune some aspects of Hazelcast Client. You can set them as property name and value pairs through declarative configuration, programmatic configuration, or JVM system property. Please see the [System Properties appendix](#) to learn how to set these properties.



When you want to reconfigure a system property, you need to restart the members for which the property is modified.

The table below lists the client configuration properties with their descriptions.

Property Name	Default Value	Type	Description
<code>hazelcast.client.event.queue.capacity</code>	1000000	string	Default value of the capacity of executor that handles incoming event packets.
<code>hazelcast.client.event.thread.count</code>	5	string	Thread count for handling incoming event packets.
<code>hazelcast.client.heartbeat.interval</code>	10000	string	Frequency of heartbeat messages sent by the clients to members.
<code>hazelcast.client.heartbeat.timeout</code>	60000	string	Timeout for the heartbeat messages sent by the client to members. If no messages pass between client and member within the given time via this property in milliseconds, the connection will be closed.
<code>hazelcast.client.max.concurrent.invocations</code>	Integer.MAX_VALUE	string	Maximum allowed number of concurrent invocations. You can apply a constraint on the number of concurrent invocations in order to prevent the system from overloading. If the maximum number of concurrent invocations is exceeded and a new invocation comes in, Hazelcast throws <code>HazelcastOverloadException</code> .
<code>hazelcast.client.invocation.timeout.seconds</code>	120	string	Period, in seconds, to give up the invocation when a member in the member list is not reachable.

Property Name	Default Value	Type	Description
<code>hazelcast.client.shuffle.member.list</code>	true	string	The client shuffles the given member list to prevent all clients to connect to the same member when this property is <code>true</code> . When it is set to <code>false</code> , the client tries to connect to the members in the given order.
<code>hazelcast.compatibility.3.6.server</code>	false	bool	When this property is true, if the client cannot know the server version, it will assume that the server has the version 3.6.x.
<code>hazelcast.invalidation.max.tolerated.miss.count</code>	10	int	If missed invalidation count is bigger than this value, relevant cached data will be made unreachable.
<code>hazelcast.invalidation.reconciliation.interval.seconds</code>	60	int	Period, in seconds, for which the clients are scanned to compare generated invalidation events with the received ones from Near Cache.
<code>hazelcast.client.statistics.enabled</code>	false	bool	If set to <code>true</code> , it enables collecting the client statistics and sending them to the cluster. When it is <code>true</code> you can monitor the clients that are connected to your Hazelcast cluster, using Hazelcast Management Center. Please refer to the <a href="#">Monitoring Clients section</a> in the Hazelcast Management Center Reference Manual for more information.

Property Name	Default Value	Type	Description
<code>hazelcast.client.statistics.period.seconds</code>	3	int	Period in seconds the client statistics are collected and sent to the cluster. Please refer to the <a href="#">Monitoring Clients</a> section in the Hazelcast Management Center Reference Manual for more information. on the client statistics.
<code>hazelcast.client.responsequeue.idlestrategy</code>	block	string	Specifies whether the response thread for internal operations at the client side will be blocked or not. If you use <code>block</code> (the default value) the thread will be blocked and need to be notified which can cause a reduction in the performance. If you use <code>backoff</code> there will be no blocking. By enabling the backoff mode and depending on your use case, you can get a 5-10% performance improvement. However, keep in mind that this will increase CPU utilization. We recommend you to use backoff with care and if you have a tool for measuring your cluster's performance.

### 16.1.5. Using High-Density Memory Store with Java Client

#### Hazelcast IMDG Enterprise HD

If you have **Hazelcast IMDG Enterprise HD**, your Hazelcast Java client's Near Cache can benefit from the High-Density Memory Store.

Let's recall the Java client's Near Cache configuration (please see the [Configuring Client Near Cache](#) section) **without** High-Density Memory Store:

```

<hazelcast-client>
  ...
  ...
  <near-cache name="MENU">
    <max-size>2000</max-size>
    <time-to-live-seconds>0</time-to-live-seconds>
    <max-idle-seconds>0</max-idle-seconds>
    <eviction-policy>LFU</eviction-policy>
    <invalidate-on-change>true</invalidate-on-change>
    <in-memory-format>OBJECT</in-memory-format>
  </near-cache>
  ...
</hazelcast-client>

```

You can configure this Near Cache to use Hazelcast's High-Density Memory Store by setting the in-memory format to NATIVE. Please see the following configuration example:

```

<hazelcast-client>
  ...
  ...
  <near-cache>
    ...
    <time-to-live-seconds>0</time-to-live-seconds>
    <max-idle-seconds>0</max-idle-seconds>
    <invalidate-on-change>true</invalidate-on-change>
    <in-memory-format>NATIVE</in-memory-format>
    <eviction size="1000" max-size-policy="ENTRY_COUNT" eviction-policy="LFU"/>
    ...
  </near-cache>
</hazelcast-client>

```

Please notice that when the in-memory format is NATIVE, i.e., High-Density Memory Store is enabled, the configuration element `<eviction>` is used to specify the eviction behavior of your client's Near Cache. In this case, the elements `<max-size>` and `<eviction-policy>` used in the configuration of a Near Cache without High-Density Memory Store do not have any impact.

The element `<eviction>` has the following attributes:

- **size**: Maximum size (entry count) of the Near Cache.
- **max-size-policy**: Maximum size policy for eviction of the Near Cache. Available values are as follows:
  - `ENTRY_COUNT`: Maximum entry count per member.
  - `USED_NATIVE_MEMORY_SIZE`: Maximum used native memory size in megabytes.
  - `USED_NATIVE_MEMORY_PERCENTAGE`: Maximum used native memory percentage.
  - `FREE_NATIVE_MEMORY_SIZE`: Minimum free native memory size to trigger cleanup.

- `FREE_NATIVE_MEMORY_PERCENTAGE`: Minimum free native memory percentage to trigger cleanup.
- `eviction-policy`: Eviction policy configuration. Its default values is `NONE`. Available values are as follows:
  - `NONE`: No items will be evicted and the property `max-size` will be ignored. You still can combine it with `time-to-live-seconds`.
  - `LRU`: Least Recently Used.
  - `LFU`: Least Frequently Used.

Keep in mind that you should have already enabled the High-Density Memory Store usage for your client, using the `<native-memory>` element in the client's configuration.

Please see the [High-Density Memory Store section](#) for more information on Hazelcast's High-Density Memory Store feature.

## 16.2. C++ Client

You can use the native C++ client to connect to Hazelcast cluster members and perform almost all operations that a member can perform. Clients differ from members in that clients do not hold data. The C++ client is by default a smart client, i.e., it knows where the data is and asks directly for the correct member. You can disable this feature (using the `ClientConfig::setSmart` method) if you do not want the clients to connect to every member.

The features of C++ clients are listed below:

- Access to distributed data structures (`IMap`, `IQueue`, `MultiMap`, `ITopic`, etc.).
- Access to transactional distributed data structures (`TransactionalMap`, `TransactionalQueue`, etc.).
- Ability to add cluster listeners to a cluster and entry/item listeners to distributed data structures.
- Distributed synchronization mechanisms with `ILock`, `ISemaphore` and `ICountDownLatch`.

Please refer to C++ client's own GitHub [repo](#) for information on setting the client up, installing and compiling it, its serialization support and APIs such as raw pointer and query.

## 16.3. .NET Client

You can use the native .NET client to connect to Hazelcast client members. You need to add `HazelcastClient3x.dll` into your .NET project references. The API is very similar to the Java native client.

Please refer to .NET client's own GitHub repo at [Hazelcast .NET Client](#) for information on configuring and starting the client.



## 16.4. REST Client

Hazelcast provides a REST interface, i.e. it provides an HTTP service in each cluster member so that you can access your `map` and `queue` using HTTP protocol. Assuming `mapName` and `queueName` are already configured in your Hazelcast, its structure is shown below.

`http://member IP address:port/hazelcast/rest/maps/mapName/key`

`http://member IP address:port/hazelcast/rest/queues/queueName`

For the operations to be performed, standard REST conventions for HTTP calls are used.



REST client request listener service is not enabled by default. You should enable it on your cluster members to use REST client. It can be enabled using the system property `hazelcast.rest.enabled`. Please refer to the [System Properties appendix](#) for the definition of this property and how to set a system property.

### 16.4.1. REST Client GET/POST/DELETE Examples

In the following GET, POST and DELETE examples, assume that your cluster members are as shown below.

```
Members [5] {  
  Member [10.20.17.1:5701]  
  Member [10.20.17.2:5701]  
  Member [10.20.17.4:5701]  
  Member [10.20.17.3:5701]  
  Member [10.20.17.5:5701]  
}
```

All of the requests below can return one of the following responses in case of a failure.

- If the HTTP request syntax is not known, the following response will be returned.



```
HTTP/1.1 400 Bad Request  
Content-Length: 0
```

- In case of an unexpected exception, the following response will be returned.

```
< HTTP/1.1 500 Internal Server Error  
< Content-Length: 0
```

## Creating/Updating Entries in a Map for REST Client

You can put a new `key1/value1` entry into a map by using POST call to <http://10.20.17.1:5701/hazelcast/rest/maps/mapName/key1> URL. This call's content body should contain the value of the key. Also, if the call contains the MIME type, Hazelcast stores this information, too.

A sample POST call is shown below.

```
$ curl -v -X POST -H "Content-Type: text/plain" -d "bar"
http://10.20.17.1:5701/hazelcast/rest/maps/mapName/foo
```

It will return the following response if successful:

```
< HTTP/1.1 200 OK
< Content-Type: text/plain
< Content-Length: 0
```

## Retrieving Entries from a Map for REST Client

If you want to retrieve an entry, you can use a GET call to <http://10.20.17.1:5701/hazelcast/rest/maps/mapName/key1>. You can also retrieve this entry from another member of your cluster, such as <http://10.20.17.3:5701/hazelcast/rest/maps/mapName/key1>.

An example of a GET call is shown below.

```
$ curl -X GET http://10.20.17.3:5701/hazelcast/rest/maps/mapName/foo
```

It will return the following response if there is a corresponding value:

```
< HTTP/1.1 200 OK
< Content-Type: text/plain
< Content-Length: 3
bar
```

This GET call returned a value, its length and also the MIME type (`text/plain`) since the POST call example shown above included the MIME type.

It will return the following if there is no mapping for the given key:

```
< HTTP/1.1 204 No Content
< Content-Length: 0
```

## Removing Entries from a Map for REST Client

You can use a DELETE call to remove an entry. A sample DELETE call is shown below with its

response.

```
$ curl -v -X DELETE http://10.20.17.1:5701/hazelcast/rest/maps/mapName/foo
```

```
< HTTP/1.1 200 OK  
< Content-Type: text/plain  
< Content-Length: 0
```

If you leave the key empty as follows, DELETE will delete all entries from the map.

```
$ curl -v -X DELETE http://10.20.17.1:5701/hazelcast/rest/maps/mapName
```

```
< HTTP/1.1 200 OK  
< Content-Type: text/plain  
< Content-Length: 0
```

### Offering Items on a Queue for REST Client

You can use a POST call to create an item on the queue. A sample is shown below.

```
$ curl -v -X POST -H "Content-Type: text/plain" -d "foo"  
http://10.20.17.1:5701/hazelcast/rest/queues/myEvents
```

The above call is equivalent to `HazelcastInstance.getQueue("myEvents").offer("foo");`.

It will return the following if successful:

```
< HTTP/1.1 200 OK  
< Content-Type: text/plain  
< Content-Length: 0
```

It will return the following if the queue is full and the item is not able to be offered to the queue:

```
< HTTP/1.1 503 Service Unavailable  
< Content-Length: 0
```

### Retrieving Items from a Queue for REST Client

You can use a DELETE call for retrieving items from a queue. Note that you should state the poll timeout while polling for queue events by an extra path parameter.

An example is shown below (**10** being the timeout value).

```
$ curl -v -X DELETE \http://10.20.17.1:5701/hazelcast/rest/queues/myEvents/10
```

The above call is equivalent to `HazelcastInstance.getQueue("myEvents").poll(10, SECONDS);`. Below is the response.

```
< HTTP/1.1 200 OK
< Content-Type: text/plain
< Content-Length: 3
foo
```

When the timeout is reached, the response will be `No Content` success, i.e. there is no item on the queue to be returned.

```
< HTTP/1.1 204 No Content
< Content-Length: 0
```

### Getting the size of the queue for REST Client

```
$ curl -v -X GET \http://10.20.17.1:5701/hazelcast/rest/queues/myEvents/size
```

The above call is equivalent to `HazelcastInstance.getQueue("myEvents").size();`. Below is a sample response.

```
< HTTP/1.1 200 OK
< Content-Type: text/plain
< Content-Length: 1
5
```

## 16.4.2. Checking the Status of the Cluster for REST Client

Besides the above operations, you can check the status of your cluster, a sample of which is shown below.

```
$ curl -v http://127.0.0.1:5701/hazelcast/rest/cluster
```

The return will be similar to the following:

```
< HTTP/1.1 200 OK
< Content-Length: 119

Members [5] {
  Member [10.20.17.1:5701] this
  Member [10.20.17.2:5701]
  Member [10.20.17.4:5701]
  Member [10.20.17.3:5701]
  Member [10.20.17.5:5701]
}

ConnectionCount: 5
AllConnectionCount: 20
```

RESTful access is provided through any member of your cluster. You can even put an HTTP load-balancer in front of your cluster members for load balancing and fault tolerance.



You need to handle the failures on REST polls as there is no transactional guarantee.

## 16.5. Memcache Client



Hazelcast Memcache Client only supports ASCII protocol. Binary Protocol is not supported.

A Memcache client written in any language can talk directly to a Hazelcast cluster. No additional configuration is required.



Memcache client request listener service is not enabled by default. You should enable it on your cluster members to use Memcache client. It can be enabled using the system property `hazelcast.memcache.enabled`. Please refer to the [System Properties appendix](#) for the definition of this property and how to set a system property.

### 16.5.1. Memcache Client Code Examples

Assume that your cluster members are as shown below.

```
Members [5] {
  Member [10.20.17.1:5701]
  Member [10.20.17.2:5701]
  Member [10.20.17.4:5701]
  Member [10.20.17.3:5701]
  Member [10.20.17.5:5701]
}
```

Assume that you have a PHP application that uses PHP Memcache client to cache things in Hazelcast. All you need to do is have your PHP Memcache client connect to one of these members. It does not matter which member the client connects to because the Hazelcast cluster looks like one giant machine (Single System Image). Here is a PHP client code example.

```
<?php
  $memcache = new Memcache;
  $memcache->connect( '10.20.17.1', 5701 ) or die ( "Could not connect" );
  $memcache->set( 'key1', 'value1', 0, 3600 );
  $get_result = $memcache->get( 'key1' ); // retrieve your data
  var_dump( $get_result ); // show it
?>
```

Notice that Memcache client connects to `10.20.17.1` and uses port `5701`. Here is a Java client code example with `SpyMemcached` client:

```
MemcachedClient client = new MemcachedClient(
  AddrUtil.getAddresses( "10.20.17.1:5701 10.20.17.2:5701" ) );
client.set( "key1", 3600, "value1" );
System.out.println( client.get( "key1" ) );
```

If you want your data to be stored in different maps, for example to utilize per map configuration, you can do that with a map name prefix as in the following example code.

```
MemcachedClient client = new MemcachedClient(
  AddrUtil.getAddresses( "10.20.17.1:5701 10.20.17.2:5701" ) );
client.set( "map1:key1", 3600, "value1" ); // store to *hz_memcache_map1
client.set( "map2:key1", 3600, "value1" ); // store to hz_memcache_map2
System.out.println( client.get( "key1" ) ); // get from hz_memcache_map1
System.out.println( client.get( "key2" ) ); // get from hz_memcache_map2
```

**hz\_memcache prefix** separates Memcache maps from Hazelcast maps. If no map name is given, it will be stored in a default map named **hz\_memcache\_default**.

An entry written with a Memcache client can be read by another Memcache client written in another language.

## 16.5.2. Unsupported Operations for Memcache

- CAS operations are not supported. In operations that get CAS parameters, such as append, CAS values are ignored.
- Only a subset of statistics are supported. Below is the list of supported statistic values.
  - cmd\_set
  - cmd\_get
  - incr\_hits
  - incr\_misses
  - decr\_hits
  - decr\_misses

## 16.6. Python Client

Python Client implementation for Hazelcast. It is implemented using the Hazelcast Open Binary Client Protocol.

See [Hazelcast Python Client](#) for its documentation.

## 16.7. Node.js Client

Node.js Client implementation for Hazelcast. It is implemented using the Hazelcast Open Binary Client Protocol.

See [Hazelcast Node.js Client](#) for its documentation.

## 16.8. Go Client

Go Client implementation for Hazelcast. It is implemented using the Hazelcast Open Binary Client Protocol.

See [Go Client](#) for its documentation.

## 16.9. Scala

The API for Hazelcast Scala is based on Scala 2.11 and Hazelcast 3.6/3.7/3.8 releases. However, these are not hard dependencies provided that you include the relevant Hazelcast dependencies.

See [Hazelcast Scala](#) for its documentation.

## 17. Serialization

Hazelcast needs to serialize the Java objects that you put into Hazelcast because Hazelcast is a distributed system. The data and its replicas are stored in different partitions on multiple cluster

members. The data you need may not be present on the local member, and in that case, Hazelcast retrieves that data from another member. This requires serialization.

Hazelcast serializes all your objects into an instance of `com.hazelcast.nio.serialization.Data`. `Data` is the binary representation of an object.

Serialization is used in the following cases:

- Adding key/value objects to a map
- Putting items in a queue/set/list
- Sending a runnable using an executor service
- Processing an entry within a map
- Locking an object
- Sending a message to a topic

Hazelcast optimizes the serialization for the basic types and their array types. You cannot override this behavior.

#### Default Types;

- Byte, Boolean, Character, Short, Integer, Long, Float, Double, String
- `byte[]`, `boolean[]`, `char[]`, `short[]`, `int[]`, `long[]`, `float[]`, `double[]`, `String[]`
- `java.util.Date`, `java.math.BigInteger`, `java.math.BigDecimal`, `java.lang.Class`

Hazelcast optimizes all of the above object types. You do not need to worry about their (de)serializations.

## 17.1. Serialization Interface Types

For complex objects, use the following interfaces for serialization and deserialization.

- `java.io.Serializable`: Please see the [Implementing Java Serializable and Externalizable](#) section.
- `java.io.Externalizable`: Please see the [Implementing Java Externalizable](#) section.
- `com.hazelcast.nio.serialization.DataSerializable`: Please see the [Implementing DataSerializable](#) section.
- `com.hazelcast.nio.serialization.IdentifiedDataSerializable`: Please see the [IdentifiedDataSerializable](#) section.
- `com.hazelcast.nio.serialization.Portable`: Please see the [Implementing Portable Serialization](#) section.
- Custom Serialization (using [StreamSerializer](#) and [ByteArraySerializer](#)).
- Global Serializer: Please see the [Global Serializer](#) section for details.

When Hazelcast serializes an object into `Data`:

1. It first checks whether the object is `null`.



2. If the above check fails, then Hazelcast checks if it is an instance of `com.hazelcast.nio.serialization.DataSerializable` or `com.hazelcast.nio.serialization.IdentifiedDataSerializable`.
3. If the above check fails, then Hazelcast checks if it is an instance of `com.hazelcast.nio.serialization.Portable`.
4. If the above check fails, then Hazelcast checks if it is an instance of one of the default types (see the [Serialization chapter introduction](#) for default types).
5. If the above check fails, then Hazelcast looks for a user-specified [Custom Serializer](#), i.e. an implementation of `ByteArraySerializer` or `StreamSerializer`. Custom serializer is searched using the input Object's Class and its parent class up to Object. If parent class search fails, all interfaces implemented by the class are also checked (excluding `java.io.Serializable` and `java.io.Externalizable`).
6. If the above check fails, then Hazelcast checks if it is an instance of `java.io.Serializable` or `java.io.Externalizable` and a Global Serializer is not registered with Java Serialization Override feature.
7. If the above check fails, Hazelcast will use the registered Global Serializer if one exists.

If all of the above checks fail, then serialization will fail. When a class implements multiple interfaces, the above steps are important to determine the serialization mechanism that Hazelcast will use. When a class definition is required for any of these serializations, you need to have all the classes needed by the application on your classpath because Hazelcast does not download them automatically, unless you are using [user code deployment](#).

## 17.2. Comparing Serialization Interfaces

The table below provides a comparison between the interfaces listed in the previous section to help you in deciding which interface to use in your applications.

Serialization Interface	Advantages	Drawbacks
Serializable	<ul style="list-style-type: none"> <li>* A standard and basic Java interface</li> <li>* Requires no implementation</li> </ul>	<ul style="list-style-type: none"> <li>* More time and CPU usage</li> <li>* More space occupancy</li> <li>* Not supported by Native clients</li> </ul>
Externalizable	<ul style="list-style-type: none"> <li>* A standard Java interface</li> <li>* More CPU and memory usage efficient than Serializable</li> </ul>	<ul style="list-style-type: none"> <li>* Serialization interface must be implemented</li> <li>* Not supported by Native clients</li> </ul>
DataSerializable	<ul style="list-style-type: none"> <li>* More CPU and memory usage efficient than Serializable</li> </ul>	<ul style="list-style-type: none"> <li>* Specific to Hazelcast</li> <li>* Not supported by Native clients</li> </ul>

Serialization Interface	Advantages	Drawbacks
IdentifiedDataSerializable	<ul style="list-style-type: none"> <li>* More CPU and memory usage efficient than Serializable</li> <li>* Reflection is not used during deserialization</li> <li>* Supported by all Native Clients</li> </ul>	<ul style="list-style-type: none"> <li>* Specific to Hazelcast</li> <li>* Serialization interface must be implemented</li> <li>* A Factory and configuration must be implemented</li> </ul>
Portable	<ul style="list-style-type: none"> <li>* More CPU and memory usage efficient than Serializable</li> <li>* Reflection is not used during deserialization</li> <li>* Versioning is supported</li> <li>* Partial deserialization is supported during Queries</li> <li>* Supported by all Native Clients</li> </ul>	<ul style="list-style-type: none"> <li>* Specific to Hazelcast</li> <li>* Serialization interface must be implemented</li> <li>* A Factory and configuration must be implemented</li> <li>* Class definition is also sent with data but stored only once per class</li> </ul>
Custom Serialization	<ul style="list-style-type: none"> <li>* Does not require class to implement an interface</li> <li>* Convenient and flexible</li> <li>* Can be based on StreamSerializer ByteArraySerializer</li> </ul>	<ul style="list-style-type: none"> <li>* Serialization interface must be implemented</li> <li>* Plug in and configuration is required</li> </ul>

Let's dig into the details of the above serialization mechanisms in the following sections.

## 17.3. Implementing Java Serializable and Externalizable

A class often needs to implement the `java.io.Serializable` interface; native Java serialization is the easiest way to do serialization.

Let's take a look at the example code below for Java Serializable.

```

public class Employee implements Serializable {
    private static final long serialVersionUID = 1L;
    private String surname;

    public Employee( String surname ) {
        this.surname = surname;
    }
}

```

Here, the fields that are non-static and non-transient are automatically serialized. To eliminate class compatibility issues, it is recommended that you add a `serialVersionUID`, as shown above. Also, when you are using methods that perform byte-content comparisons, such as `IMap.replace()`, and if byte-content of equal objects is different, you may face unexpected behaviors. For example, if the class relies on a hash map, the `replace` method may fail. The reason for this is the hash map is a serialized data structure with unreliable byte-content.

### 17.3.1. Implementing Java Externalizable

Hazelcast also supports `java.io.Externalizable`. This interface offers more control on the way fields are serialized or deserialized. Compared to native Java serialization, it also can have a positive effect on performance. With `java.io.Externalizable`, there is no need to add `serialVersionUID`.

Let's take a look at the example code below.

```

public class Employee implements Externalizable {
    private String surname;
    public Employee(String surname) {
        this.surname = surname;
    }

    @Override
    public void readExternal( ObjectInput in )
        throws IOException, ClassNotFoundException {
        this.surname = in.readUTF();
    }

    @Override
    public void writeExternal( ObjectOutput out )
        throws IOException {
        out.writeUTF(surname);
    }
}

```

You explicitly perform writing and reading of fields. Perform reading in the same order as writing.

## 17.4. Implementing DataSerializable

As mentioned in [Implementing Java Serializable & Externalizable](#), Java serialization is an easy mechanism. However, it does not control how fields are serialized or deserialized. Moreover, Java serialization can lead to excessive CPU loads since it keeps track of objects to handle the cycles and streams class descriptors. These are performance decreasing factors; thus, serialized data may not have an optimal size.

The `DataSerializable` interface of Hazelcast overcomes these issues. Here is an example of a class implementing the `com.hazelcast.nio.serialization.DataSerializable` interface.

```
public class Address implements DataSerializable {
    private String street;
    private int zipCode;
    private String city;
    private String state;

    public Address() {}

    //getters setters..

    public void writeData( ObjectDataOutput out ) throws IOException {
        out.writeUTF(street);
        out.writeInt(zipCode);
        out.writeUTF(city);
        out.writeUTF(state);
    }

    public void readData( ObjectDataInput in ) throws IOException {
        street = in.readUTF();
        zipCode = in.readInt();
        city = in.readUTF();
        state = in.readUTF();
    }
}
```

### 17.4.1. Reading and Writing and DataSerializable

Let's take a look at another example which encapsulates a `DataSerializable` field.

Since the `address` field itself is `DataSerializable`, it calls `address.writeData(out)` when writing and `address.readData(in)` when reading. Also note that you should have writing and reading of the fields occur in the same order. When Hazelcast serializes a `DataSerializable`, it writes the `className` first. When Hazelcast deserializes it, `className` is used to instantiate the object using reflection.

```

public class Employee implements DataSerializable {
    private String firstName;
    private String lastName;
    private int age;
    private double salary;
    private Address address; //address itself is DataSerializable

    public Employee() {}

    //getters setters..

    public void writeData( ObjectDataOutput out ) throws IOException {
        out.writeUTF(firstName);
        out.writeUTF(lastName);
        out.writeInt(age);
        out.writeDouble (salary);
        address.writeData (out);
    }

    public void readData( ObjectDataInput in ) throws IOException {
        firstName = in.readUTF();
        lastName = in.readUTF();
        age = in.readInt();
        salary = in.readDouble();
        address = new Address();
        // since Address is DataSerializable let it read its own internal state
        address.readData(in);
    }
}

```

As you can see, since the `address` field itself is `DataSerializable`, it calls `address.writeData(out)` when writing and `address.readData(in)` when reading. Also note that you should have writing and reading of the fields occur in the same order. While Hazelcast serializes a `DataSerializable`, it writes the `className` first. When Hazelcast deserializes it, `className` is used to instantiate the object using reflection.



Since Hazelcast needs to create an instance during deserialization, `DataSerializable` class has a no-arg constructor.



`DataSerializable` is a good option if serialization is only needed for in-cluster communication.



`DataSerializable` is not supported by non-Java clients as it uses Java reflection. If you need non-Java clients, please use `IdentifiedDataSerializable` or `Portable`.

## 17.4.2. IdentifiedDataSerializable

For a faster serialization of objects, avoiding reflection and long class names, Hazelcast recommends you implement `com.hazelcast.nio.serialization.IdentifiedDataSerializable` which is a slightly better version of `DataSerializable`.

`DataSerializable` uses reflection to create a class instance, as mentioned in [Implementing DataSerializable](#). But `IdentifiedDataSerializable` uses a factory for this purpose and it is faster during deserialization, which requires new instance creations.

### getID and getFactoryId Methods

`IdentifiedDataSerializable` extends `DataSerializable` and introduces two new methods.

- `int getId();`
- `int getFactoryId();`

`IdentifiedDataSerializable` uses `getId()` instead of class name and it uses `getFactoryId()` to load the class when given the Id. To complete the implementation, you should also implement `com.hazelcast.nio.serialization.DataSerializableFactory` and register it into `SerializationConfig`, which can be accessed from `Config.getSerializationConfig()`. Factory's responsibility is to return an instance of the right `IdentifiedDataSerializable` object, given the Id. This is currently the most efficient way of Serialization that Hazelcast supports off the shelf.

### Implementing IdentifiedDataSerializable

Let's take a look at the following example code and configuration to see `IdentifiedDataSerializable` in action.

```

public class Employee
    implements IdentifiedDataSerializable {

    private String surname;

    public Employee() {}

    public Employee( String surname ) {
        this.surname = surname;
    }

    @Override
    public void readData( ObjectDataInput in )
        throws IOException {
        this.surname = in.readUTF();
    }

    @Override
    public void writeData( ObjectDataOutput out )
        throws IOException {
        out.writeUTF( surname );
    }

    @Override
    public int getFactoryId() {
        return EmployeeDataSerializableFactory.FACTORY_ID;
    }

    @Override
    public int getId() {
        return EmployeeDataSerializableFactory.EMPLOYEE_TYPE;
    }

    @Override
    public String toString() {
        return String.format( "Employee(surname=%s)", surname );
    }
}

```

The methods `getId` and `getFactoryId` return a unique positive number within the `EmployeeDataSerializableFactory`. Now, let's create an instance of this `EmployeeDataSerializableFactory`.

```

public class EmployeeDataSerializableFactory
    implements DataSerializableFactory{

    public static final int FACTORY_ID = 1;

    public static final int EMPLOYEE_TYPE = 1;

    @Override
    public IdentifiedDataSerializable create(int typeId) {
        if ( typeId == EMPLOYEE_TYPE ) {
            return new Employee();
        } else {
            return null;
        }
    }
}

```

The only method you should implement is `create`, as seen in the above example. It is recommended that you use a `switch-case` statement instead of multiple `if-else` blocks if you have a lot of subclasses. Hazelcast throws an exception if null is returned for `typeId`.

### Registering `EmployeeDataSerializableFactory`

As the last step, you need to register `EmployeeDataSerializableFactory` declaratively (declare in the configuration file `hazelcast.xml`) as shown below. Note that `factory-id` has the same value of `FACTORY_ID` in the above code. This is crucial to enable Hazelcast to find the correct factory.

```

<hazelcast>
...
<serialization>
  <data-serializable-factories>
    <data-serializable-factory factory-id="1">
      EmployeeDataSerializableFactory
    </data-serializable-factory>
  </data-serializable-factories>
</serialization>
...
</hazelcast>

```



Please refer to the [Serialization Configuration Wrap-Up](#) section for a full description of Hazelcast Serialization configuration.

## 17.5. Implementing Portable Serialization

As an alternative to the existing serialization methods, Hazelcast offers a language/platform independent Portable serialization that has the following advantages:



- Supports multi-version of the same object type.
- Fetches individual fields without having to rely on reflection.
- Queries and indexing support without deserialization and/or reflection.

In order to support these features, a serialized Portable object contains meta information like the version and the concrete location of the each field in the binary data. This way, Hazelcast navigates in the `byte[]` and deserializes only the required field without actually deserializing the whole object. This improves the Query performance.

With multi-version support, you can have two cluster members where each has different versions of the same object. Hazelcast will store both meta information and use the correct one to serialize and deserialize Portable objects depending on the member. This is very helpful when you are doing a rolling upgrade without shutting down the cluster.

Portable serialization is totally language independent and is used as the binary protocol between Hazelcast server and clients.

### **17.5.1. Portable Serialization Example Code**

Here is example code for Portable implementation of a Foo class.

```

public class Foo implements Portable {
    final static int ID = 5;

    private String foo;

    public String getFoo() {
        return foo;
    }

    public void setFoo( String foo ) {
        this.foo = foo;
    }

    @Override
    public int getFactoryId() {
        return 1;
    }

    @Override
    public int getClassId() {
        return ID;
    }

    @Override
    public void writePortable( PortableWriter writer ) throws IOException {
        writer.writeUTF( "foo", foo );
    }

    @Override
    public void readPortable( PortableReader reader ) throws IOException {
        foo = reader.readUTF( "foo" );
    }
}

```

Similar to `IdentifiedDataSerializable`, a Portable Class must provide `classId` and `factoryId`. The Factory object creates the Portable object given the `classId`.

An example `Factory` could be implemented as follows:

```

public class MyPortableFactory implements PortableFactory {

    @Override
    public Portable create( int classId ) {
        if ( Foo.ID == classId )
            return new Foo();
        else
            return null;
    }
}

```

### 17.5.2. Registering the Portable Factory

The last step is to register the `Factory` to the `SerializationConfig`. Below are the programmatic and declarative configurations for this step.

```

Config config = new Config();
config.getSerializationConfig().addPortableFactory( 1, new MyPortableFactory() );

```

```

<hazelcast>
  <serialization>
    <portable-version>0</portable-version>
    <portable-factories>
      <portable-factory factory-id="1">
        com.hazelcast.nio.serialization.MyPortableFactory
      </portable-factory>
    </portable-factories>
  </serialization>
</hazelcast>

```

Note that the `id` that is passed to the `SerializationConfig` is the same as the `factoryId` that the `Foo` class returns.

### 17.5.3. Versioning for Portable Serialization

More than one version of the same class may need to be serialized and deserialized. For example, a client may have an older version of a class and the member to which it is connected may have a newer version of the same class.

Portable serialization supports versioning. It is a global versioning, meaning that all portable classes that are serialized through a member get the globally configured portable version.

You can declare Version in the configuration file `hazelcast.xml` using the `portable-version` element, as shown below.

```
<serialization>
  <portable-version>1</portable-version>
  <portable-factories>
    <portable-factory factory-id="1">
      PortableFactoryImpl
    </portable-factory>
  </portable-factories>
</serialization>
```

You can also use the interface `VersionedPortable` which enables to upgrade the version per class, instead of global versioning. If you need to update only one class, you can use this interface. In this case, your class should implement `VersionedPortable` instead of `Portable`, and you can give the desired version using the method `VersionedPortable.getClassVersion()`.

You should consider the following when you perform versioning.

- It is important to change the version whenever an update is performed in the serialized fields of a class, for example by incrementing the version.
- If a client performs a `Portable` deserialization on a field and then that `Portable` is updated by removing that field on the cluster side, this may lead to a problem.
- `Portable` serialization does not use reflection and hence, fields in the class and in the serialized content are not automatically mapped. Field renaming is a simpler process. Also, since the class ID is stored, renaming the `Portable` does not lead to problems.
- Types of fields need to be updated carefully. Hazelcast performs basic type upgradings, such as `int` to `float`.

### Example Portable Versioning Scenarios

Assume that a new member joins to the cluster with a class that has been modified and class' version has been upgraded due to this modification.

- If you modified the class by adding a new field, the new member's `put` operations will include that new field. If this new member tries to get an object that was put from the older members, it will get `null` for the newly added field.
- If you modified the class by removing a field, the old members get `null` for the objects that are put by the new member.
- If you modified the class by changing the type of a field, the error `IncompatibleClassChangeError` is generated unless the change was made on a built-in type or the byte size of the new type is less than or equal to the old one. The following are example allowed type conversions:
  - `long` → `int`, `byte`, `char`, `short`
  - `int` → `byte`, `char`, `short`

If you have not modify a class at all, it will work as usual.

## 17.5.4. Ordering Consistency for `writePortable`

Independent of the member-member or member-client communications, the method `writePortable()` of the classes that implement `Portable` should be consistent. This means, the fields listed under the method `writePortable()` should be in the same order for all involved members and/or clients.

Let's consider the following `Employee` class:

```
class EmployeePortable implements Portable {

    private String name;
    private int age;

    public EmployeePortable() {
    }

    public EmployeePortable(int age, String name) {
        this.age = age;
        this.name = name;
    }

    public int getFactoryId() {
        return 666;
    }

    public int getClassId() {
        return 2;
    }

    public void writePortable(PortableWriter writer) throws IOException {
        writer.writeUTF("n", name);
        writer.writeInt("a", age);
    }

    public void readPortable(PortableReader reader) throws IOException {
        name = reader.readUTF("n");
        age = reader.readInt("a");
    }

    public int getAge() {
        return age;
    }
}
```

As you see in the above example, first the `name` and then the `age` is written. This order should be preserved in other members or clients.

### 17.5.5. Null Portable Serialization

Be careful with serializing null portables. Hazelcast lazily creates a class definition of portable internally when the user first serializes. This class definition is stored and used later for deserializing that portable class. When the user tries to serialize a null portable when there is no class definition at the moment, Hazelcast throws an exception saying that `com.hazelcast.nio.serialization.HazelcastSerializationException: Cannot write null portable without explicitly registering class definition!`.

There are two solutions to get rid of this exception. Either put a non-null portable class of the same type before any other operation, or manually register a class definition in serialization configuration as shown below.

```
Config config = new Config();
final ClassDefinition classDefinition = new ClassDefinitionBuilder(Foo.factoryId, Foo
    .getClassId)
    .addUTFField("foo").build();
config.getSerializationConfig().addClassDefinition(classDefinition);
Hazelcast.newHazelcastInstance(config);
```

### 17.5.6. DistributedObject Serialization

Putting a `DistributedObject` (Hazelcast Semaphore, Queue, etc.) in a cluster member and getting it from another one is not a straightforward operation. Passing the ID and type of the `DistributedObject` can be a solution. For deserialization, you can get the object from `HazelcastInstance`. For instance, if your object is an instance of `IQueue`, you can either use `HazelcastInstance.getQueue(id)` or `Hazelcast.getDistributedObject`.

You can use the `HazelcastInstanceAware` interface in the case of a deserialization of a Portable `DistributedObject` if it gets an ID to be looked up. `HazelcastInstance` is set after deserialization, so you first need to store the ID and then retrieve the `DistributedObject` using the `setHazelcastInstance` method.



Please refer to the [Serialization Configuration Wrap-Up](#) section for a full description of Hazelcast Serialization configuration.

## 17.6. Custom Serialization

Hazelcast lets you plug in a custom serializer for serializing your objects. You can use `StreamSerializer` and `ByteArraySerializer` interfaces for this purpose.

### 17.6.1. Implementing StreamSerializer

You can use a stream to serialize and deserialize data by using `StreamSerializer`. This is a good option for your own implementations. It can also be adapted to external serialization libraries like Kryo, JSON and protocol buffers.

## StreamSerializer Example Code 1

First, let's create a simple object.

```
public class EmployeeSS {
    private String surname;
    private String name;

    public EmployeeSS( String surname ) {
        this.surname = surname;
    }

    public String getSurname() {
        return surname;
    }
    public String getName() {
        return name;
    }
}
```

Now, let's implement StreamSerializer for **Employee** class.

```
public class EmployeeStreamSerializer
    implements StreamSerializer<EmployeeSS> {

    @Override
    public int getTypeId () {
        return 1;
    }

    @Override
    public void write( ObjectDataOutput out, EmployeeSS employee )
        throws IOException {
        out.writeUTF(employee.getSurname());
    }

    @Override
    public EmployeeSS read( ObjectDataInput in )
        throws IOException {
        String surname = in.readUTF();
        return new EmployeeSS(surname);
    }

    @Override
    public void destroy () {
    }
}
```

In practice, classes may have many fields. Just make sure the fields are read in the same order as

they are written. The type ID must be unique and greater than or equal to 1. Uniqueness of the type ID enables Hazelcast to determine which serializer will be used during deserialization.

As the last step, let's register the `EmployeeStreamSerializer` in the configuration file `hazelcast.xml`, as shown below.

```
<serialization>
  <serializers>
    <serializer type-class="Employee" class-name="EmployeeStreamSerializer" />
  </serializers>
</serialization>
```



`StreamSerializer` cannot be created for well-known types, such as Long and String and primitive arrays. Hazelcast already registers these types.

### StreamSerializer Example Code 2

Let's take a look at another example implementing `StreamSerializer`.

```
public class Foo {
    private String foo;

    public String getFoo() {
        return foo;
    }

    public void setFoo( String foo ) {
        this.foo = foo;
    }
}
```

Assume that our custom serialization will serialize Foo into XML. First you need to implement a `com.hazelcast.nio.serialization.StreamSerializer`. A very simple one that uses `XMLEncoder` and `XMLDecoder` could look like the following:



```

public class FooXmlSerializer implements StreamSerializer<Foo> {

    @Override
    public int getTypeId() {
        return 10;
    }

    public void write( ObjectDataOutput out, Foo object ) throws IOException {
        ByteArrayOutputStream bos = new ByteArrayOutputStream();
        XMLEncoder encoder = new XMLEncoder( bos );
        encoder.writeObject( object );
        encoder.close();
        out.write( bos.toByteArray() );
    }

    public Foo read( ObjectDataInput in ) throws IOException {
        InputStream inputStream = (InputStream) in;
        XMLDecoder decoder = new XMLDecoder( inputStream );
        return (Foo) decoder.readObject();
    }

    public void destroy() {
    }
}

```

## Configuring StreamSerializer

Note that `typeId` must be unique because Hazelcast will use it to look up the `StreamSerializer` while it deserializes the object. The last required step is to register the `StreamSerializer` in your Hazelcast configuration. Below are the programmatic and declarative configurations for this step.

```

SerializerConfig sc = new SerializerConfig()
    .setImplementation(new FooXmlSerializer())
    .setTypeClass(Foo.class);
Config config = new Config();
config.getSerializationConfig().addSerializerConfig(sc);

```

```

<hazelcast>
  <serialization>
    <serializers>
      <serializer type-class="com.www.Foo" class-name="com.www.FooXmlSerializer" />
    </serializers>
  </serialization>
</hazelcast>

```

From now on, this Hazelcast example will use `FooXmlSerializer` to serialize `Foo` objects. In this way, you can write an adapter (`StreamSerializer`) for any Serialization framework and plug it into

Hazelcast.



Please refer to the [Serialization Configuration Wrap-Up](#) section for a full description of Hazelcast Serialization configuration.

## 17.6.2. Implementing ByteArraySerializer

`ByteArraySerializer` exposes the raw `ByteArray` used internally by Hazelcast. It is a good option if the serialization library you are using deals with `ByteArrays` instead of streams.

Let's implement `ByteArraySerializer` for the `Employee` class mentioned in [Implementing StreamSerializer](#).

```
public class EmployeeByteArraySerializer
    implements ByteArraySerializer<EmployeeSS> {

    @Override
    public void destroy () {
    }

    @Override
    public int getTypeId () {
        return 1;
    }

    @Override
    public byte[] write( EmployeeSS object )
        throws IOException {
        return object.getName().getBytes();
    }

    @Override
    public EmployeeSS read( byte[] buffer )
        throws IOException {
        String surname = new String( buffer );
        return new EmployeeSS( surname );
    }
}
```

### Configuring ByteArraySerializer

As usual, let's register the `EmployeeByteArraySerializer` in the configuration file `hazelcast.xml`, as shown below.

```
<serialization>
  <serializers>
    <serializer type-class="Employee">EmployeeByteArraySerializer</serializer>
  </serializers>
</serialization>
```



Please refer to the [Serialization Configuration Wrap-Up section](#) for a full description of Hazelcast Serialization configuration.

## 17.7. Global Serializer

The global serializer is identical to [custom serializers](#) from the implementation perspective. The global serializer is registered as a fallback serializer to handle all other objects if a serializer cannot be located for them.

By default, the global serializer does not handle `java.io.Serializable` and `java.io.Externalizable` instances. However, you can configure it to be responsible for those instances.

A custom serializer should be registered for a specific class type. The global serializer will handle all class types if all the steps in searching for a serializer fail as described in [Serialization Interface Types](#).

### Use cases

- Third party serialization frameworks can be integrated using the global serializer.
- For your custom objects, you can implement a single serializer to handle all of them.
- You can replace the internal Java serialization by enabling the `overrideJavaSerialization` option of the global serializer configuration.

Any custom serializer can be used as the global serializer. Please refer to the [Custom Serialization section](#) for implementation details.



To function properly, Hazelcast needs the Java serializable objects to be handled correctly. If the global serializer is configured to handle the Java serialization, the global serializer must properly serialize/deserialize the `java.io.Serializable` instances. Otherwise, it causes Hazelcast to malfunction.\*

### 17.7.1. Sample Global Serializer

A sample global serializer that integrates with a third party serializer is shown below.

```

public class GlobalStreamSerializer
    implements StreamSerializer<Object> {

    private SomeThirdPartySerializer someThirdPartySerializer;

    private init() {
        //someThirdPartySerializer = ...
    }

    @Override
    public int getTypeId () {
        return 123;
    }

    @Override
    public void write( ObjectDataOutput out, Object object ) throws IOException {
        byte[] bytes = someThirdPartySerializer.encode(object);
        out.writeByteArray(bytes);
    }

    @Override
    public Object read( ObjectDataInput in ) throws IOException {
        byte[] bytes = in.readByteArray();
        return someThirdPartySerializer.decode(bytes);
    }

    @Override
    public void destroy () {
        someThirdPartySerializer.destroy();
    }
}

```

Now, we can register the global serializer in the configuration file `hazelcast.xml`, as shown below.

```

<serialization>
  <serializers>
    <global-serializer override-java-serialization="true">
      GlobalStreamSerializer</global-serializer>
    </serializers>
  </serialization>

```

## 17.8. Implementing HazelcastInstanceAware

You can implement the `HazelcastInstanceAware` interface to access distributed objects for cases where an object is deserialized and needs access to `HazelcastInstance`.

Let's implement it for the `Employee` class mentioned in the [Custom Serialization section](#).

```

public class PersonAwr implements Serializable, HazelcastInstanceAware {

    private static final long serialVersionUID = 1L;

    private String name;

    private transient HazelcastInstance hazelcastInstance;

    PersonAwr(String name) {
        this.name = name;
    }

    public HazelcastInstance getHazelcastInstance() {
        return hazelcastInstance;
    }

    @Override
    public void setHazelcastInstance(HazelcastInstance hz) {
        this.hazelcastInstance = hz;
        System.out.println("hazelcastInstance set");
    }

    @Override
    public String toString() {
        return String.format("Person(name=%s)", name);
    }
}

```

After deserialization, the object is checked to see if it implements `HazelcastInstanceAware` and the method `setHazelcastInstance` is called. Notice the `hazelcastInstance` is `transient`. This is because this field should not be serialized.

It may be a good practice to inject a `HazelcastInstance` into a domain object, e.g., `Employee` in the above sample, when used together with `Runnable/Callable` implementations. These runnables/callables are executed by `IExecutorService` which sends them to another machine. And after a task is deserialized, run/call method implementations need to access `HazelcastInstance`.

We recommend you only set the `HazelcastInstance` field while using `setHazelcastInstance` method and you not execute operations on the `HazelcastInstance`. The reason is that when `HazelcastInstance` is injected for a `HazelcastInstanceAware` implementation, it may not be up and running at the injection time.

## 17.9. Untrusted Deserialization Protection

Hazelcast offers a Java deserialization protection based on whitelisting and blacklisting the class/package names. These listings support prefixes.

This protection is controlled using the configuration element `java-serialization-filter` under `serialization`, as shown in the example below. op

```

<hazelcast>
  <serialization>
    <java-serialization-filter defaults-disabled="true">
      <whitelist>
        <class>example.Foo</class>
        <package>com.acme.app</package>
        <prefix>com.hazelcast.</package>
        <prefix>java.</package>
        <prefix>javax.</package>
        <prefix>[</package>
      </whitelist>
      <blacklist>
        <class>com.acme.app.BeanComparator</class>
      </blacklist>
    </java-serialization-filter>
  </serialization>
</hazelcast>

```

As an alternative, you can also configure it programmatically using the `JavaSerializationFilterConfig` object, as shown in the below example:

```

Config config = new Config();
JavaSerializationFilterConfig javaSerializationFilterConfig = new
JavaSerializationFilterConfig();
javaSerializationFilterConfig.getWhitelist().addClasses(SomeDeserialized.class.getName
());
config.getSerializationConfig().setJavaSerializationFilterConfig(javaSerializationFilt
erConfig);

```



Untrusted deserialization protection is not enabled by default. You can enable it simply by setting the element `java-serialization-filter` or using a non-null `JavaSerializationFilterConfig` object.

The protection uses a whitelist as the default configuration. When this list is not explicitly provided, the following default prefixes are used for the whitelist:

- `java`
- `com.hazelcast.`
- `[` (for primitives and arrays)

If you do not want to use the default whitelist prefixes, you must set the `defaults-disabled` attribute to true.

Once the protection is enabled, the following filtering rules are used when objects are deserialized.

- When whitelist is not provided:
  - if the deserialized object's `getClass().getName()` is blacklisted or

`getClass().getPackage().getName()` is blacklisted, then deserialization fails;

- deserialization is allowed otherwise.
- When whitelist is provided:
  - if the deserialized object's `getClass().getName()` or `getClass().getPackage().getName()` is blacklisted, then deserialization fails;
  - if the deserialized object's `getClass().getName()` or `getClass().getPackage().getName()` is whitelisted, then deserialization is allowed;
  - deserialization fails otherwise.

When deserialization fails, a `SecurityException` is thrown.



Note that the safest way to provide a protection against untrusted deserialization is using whitelisting (also keep in mind that maintaining such a whitelist can be difficult).

## 17.10. Serialization Configuration Wrap-Up

This section summarizes the configuration of serialization options, explained in the above sections, into all-in-one examples. The following are example serialization configurations.

### Declarative:

```
<serialization>
  <portable-version>2</portable-version>
  <use-native-byte-order>true</use-native-byte-order>
  <byte-order>BIG_ENDIAN</byte-order>
  <enable-compression>true</enable-compression>
  <enable-shared-object>false</enable-shared-object>
  <allow-unsafe>true</allow-unsafe>
  <data-serializable-factories>
    <data-serializable-factory factory-id="1001">
      abc.xyz.Class
    </data-serializable-factory>
  </data-serializable-factories>
  <portable-factories>
    <portable-factory factory-id="9001">
      xyz.abc.Class
    </portable-factory>
  </portable-factories>
  <serializers>
    <global-serializer>abc.Class</global-serializer>
    <serializer type-class="Employee" class-name="com.EmployeeSerializer">
    </serializer>
  </serializers>
  <check-class-def-errors>true</check-class-def-errors>
</serialization>
```

## Programmatic:

```
Config config = new Config();
SerializationConfig srzConfig = config.getSerializationConfig();
srzConfig.setPortableVersion( "2" ).setUseNativeByteOrder( true );
srzConfig.setAllowUnsafe( true ).setEnableCompression( true );
srzConfig.setCheckClassDefErrors( true );

GlobalSerializerConfig globSrzcConfig = srzConfig.getGlobalSerializerConfig();
globSrzcConfig.setClassName( "abc.Class" );

SerializerConfig serializerConfig = srzConfig.getSerializerConfig();
serializerConfig.setTypeClass( "Employee" )
    .setClassName( "com.EmployeeSerializer" );
```

Serialization configuration has the following elements.

- **portable-version**: Defines versioning of the portable serialization. Portable version differentiates two of the same classes that have changes, such as adding/removing field or changing a type of a field.
- **use-native-byte-order**: Set to **true** to use native byte order for the underlying platform. Its default value is **false**.
- **byte-order**: Defines the byte order that the serialization will use: **BIG\_ENDIAN** or **LITTLE\_ENDIAN**. Its default value is **BIG\_ENDIAN**.
- **enable-compression**: Enables compression if default Java serialization is used. Its default value is **false**.
- **enable-shared-object**: Enables shared object if default Java serialization is used. Its default value is **false**.
- **allow-unsafe**: Set to **true** to allow **unsafe** to be used. Its default value is **false**.
- **data-serializable-factory**: Custom classes implementing `com.hazelcast.nio.serialization.DataSerializableFactory` to be registered. These can be used to speed up serialization/deserialization of objects.
- **portable-factory**: The `PortableFactory` class to be registered.
- **global-serializer**: The global serializer class to be registered if no other serializer is applicable. This element has the optional boolean attribute **override-java-serialization**. If set to **true**, the Java serialization step is assumed to be handled by the global serializer. Java Serializable and Externalizable is prior to global serializer by default (**false**).
- **serializer**: The class name of the serializer implementation.
- **check-class-def-errors**: When set to **true**, the serialization system will check for class definitions error at start and will throw a `SerializationException` with an error definition.



# 18. Management

This chapter provides information on managing and monitoring your Hazelcast cluster. It gives detailed instructions related to gathering statistics, monitoring via JMX protocol and managing the cluster with useful utilities.

## 18.1. Getting Member Statistics

You can get various statistics from your distributed data structures via the Statistics API. Since the data structures are distributed in the cluster, the Statistics API provides statistics for the local portion (1/Number of Members in the Cluster) of data on each member.

### 18.1.1. Map Statistics

To get local map statistics, use the `getLocalMapStats()` method from the `IMap` interface. This method returns a `LocalMapStats` object that holds local map statistics.

Below is an example code where the `getLocalMapStats()` method and the `getOwnedEntryCount()` method get the number of entries owned by this member.

```
HazelcastInstance hazelcastInstance = Hazelcast.newHazelcastInstance();
IMap<String, String> customers = hazelcastInstance.getMap( "customers" );
LocalMapStats mapStatistics = customers.getLocalMapStats();
System.out.println( "number of entries owned on this member = "
    + mapStatistics.getOwnedEntryCount() );
```



Since Hazelcast IMDG 3.8 `getOwnedEntryMemoryCost()` method is now supported for NATIVE in-memory format as well.

The following are some of the metrics that you can access via the `LocalMapStats` object.

- Number of entries owned by the member (`getOwnedEntryCount()`).
- Number of backup entries held by the member (`getBackupEntryCount()`).
- Number of backups per entry (`getBackupCount()`).
- Memory cost (number of bytes) of owned entries in the member (`getOwnedEntryMemoryCost()`).
- Creation time of the map on the member (`getCreationTime()`).
- Number of hits (reads) of the locally owned entries (`getHits()`).
- Number of get and put operations on the map (`getPutOperationCount()` and `getGetOperationCount()`).
- Number of queries executed on the map (`getQueryCount()` and `getIndexedQueryCount()`). May be imprecise for queries involving partition predicates (`PartitionPredicate`) on off-heap storage.

Please refer to [LocalMapStats Javadoc](#) to see all the metrics.

## 18.1.2. Map Index Statistics

To access map index statistics, if you are using indexes to speed up map queries, use the `getIndexStats()` method of the `LocalMapStats` interface returned by `IMap.getLocalMapStats()`.

Below is an example where the `getIndexStats()` method is used to examine an average selectivity of index hits:

```
HazelcastInstance hazelcastInstance = Hazelcast.newHazelcastInstance();
IMap<String, String> customers = hazelcastInstance.getMap("customers");
customers.addIndex("name", true); // or add the index using the map config
LocalMapStats mapStatistics = customers.getLocalMapStats();
Map<String, LocalIndexStats> indexStats = mapStatistics.getIndexStats();
LocalIndexStats nameIndexStats = indexStats.get("name");
System.out.println("average name index hit selectivity on this member = "
    + nameIndexStats.getAverageHitSelectivity());
```

The following are some of the metrics that you can obtain via the `LocalIndexStats` interface:

- Number of queries and hits into an index (`getQueryCount()` and `getHitCount()`). Number of hits and queries may differ since a single query may hit the same index more than once.
- Average index hit latency measured in nanoseconds (`getAverageHitLatency()`).
- Average index hit selectivity (`getAverageHitSelectivity()`). Returned values are in the range from 0.0 to 1.0. Values close to 1.0 indicate a high selectivity meaning the index is efficient; values close to 0.0 indicate a low selectivity meaning the index efficiency is approaching an efficiency of a simple full scan.
- Number of index insert, update and remove operations (`getInsertCount()`, `getUpdateCount()` and `getRemoveCount()`).
- Total latencies of insert, update and remove operations (`getTotalInsertLatency()`, `getTotalUpdateLatency()`, `getTotalRemoveLatency()`). To compute an average latency divide the returned value by the number of operations of a corresponding type.
- Memory cost of an index (`getMemoryCost()`). For on-heap storages, this memory cost metric value is a best-effort approximation and doesn't indicate a precise on-heap memory usage of an index.

Refer to [LocalIndexStats Javadoc](#) to see all the metrics.

To compute an aggregated value of `getAverageHitSelectivity()` for all cluster members, you can use a simple averaging computation as shown below:

$$(s(1) + s(2) + \dots + s(n)) / n$$

In this computation,  $s(i)$  is an average hit selectivity on the member  $i$  and  $n$  is the total number of cluster members.

A more advanced solution is to compute a weighted average as shown below:

$$(s(1) * h(1) + s(2) * h(2) + \dots + s(n) * h(n)) / (h(1) + h(2) + \dots + h(n))$$

Here,  $s(i)$  is an average hit selectivity on the member  $i$ ,  $h(i)$  is a hit count (`getHitCount()`) on the member  $i$  and  $n$  is the total number of cluster members. This more advanced solution may produce more precise results in unstable dynamic clusters where new members do not have enough statistics accumulated. The same technique may be applied to the `getAverageHitLatency()` metric.

Accuracy and reliability notes:

- Values returned by `getAverageHitSelectivity()` have an accuracy of around 1% for on-heap storages.
- Values returned by `getQueryCount()` and `getHitCount()` may be imprecise for queries involving partition predicates (`PartitionPredicate`) on off-heap storage.
- Index statistics may be imprecise after a new cluster member addition or the existing member removal until enough fresh statistics is accumulated on a new owner of an index or its partition.

### 18.1.3. Near Cache Statistics

To get Near Cache statistics, use the `getNearCacheStats()` method from the `LocalMapStats` object. This method returns a `NearCacheStats` object that holds Near Cache statistics.

Below is an example code where the `getNearCacheStats()` method and the `getRatio` method from `NearCacheStats` get a Near Cache hit/miss ratio.

```
HazelcastInstance hazelcastInstance = Hazelcast.newHazelcastInstance();
IMap<String, String> customers = hazelcastInstance.getMap( "customers" );
LocalMapStats mapStatistics = customers.getLocalMapStats();
NearCacheStats nearCacheStatistics = mapStatistics.getNearCacheStats();
System.out.println( "Near Cache hit/miss ratio = "
    + nearCacheStatistics.getRatio() );
```

The following are some of the metrics that you can access via the `NearCacheStats` object. This behavior applies to both client and member Near Caches.

- Creation time of the Near Cache map on the member (`getCreationTime()`).
- Number of entries owned by the member (`getOwnedEntryCount()`).
- Memory cost (number of bytes) of owned entries in the Near Cache (`getOwnedEntryMemoryCost()`).
- Number of hits (reads) of the locally owned entries (`getHits()`).

Please refer to [NearCacheStats Javadoc](#) to see all the metrics.

### 18.1.4. Multimap Statistics

To get MultiMap statistics, use the `getLocalMultiMapStats()` method from the `MultiMap` interface. This method returns a `LocalMultiMapStats` object that holds local MultiMap statistics.

Below is an example code where the `getLocalMultiMapStats()` method and the `getLastUpdateTime` method from `LocalMultiMapStats` get the last update time.

```
HazelcastInstance hazelcastInstance = Hazelcast.newHazelcastInstance();
MultiMap<String, String> customers = hazelcastInstance.getMultiMap( "customers" );
LocalMultiMapStats multiMapStatistics = customers.getLocalMultiMapStats();
System.out.println( "last update time = "
    + multiMapStatistics.getLastUpdateTime() );
```

The following are some of the metrics that you can access via the `LocalMultiMapStats` object.

- Number of entries owned by the member (`getOwnedEntryCount()`).
- Number of backup entries held by the member (`getBackupEntryCount()`).
- Number of backups per entry (`getBackupCount()`).
- Memory cost (number of bytes) of owned entries in the member (`getOwnedEntryMemoryCost()`).
- Creation time of the multimap on the member (`getCreationTime()`).
- Number of hits (reads) of the locally owned entries (`getHits()`).
- Number of get and put operations on the map (`getPutOperationCount()` and `getGetOperationCount()`).

Please refer to [LocalMultiMapStats Javadoc](#) to see all the metrics.

### 18.1.5. Queue Statistics

To get local queue statistics, use the `getLocalQueueStats()` method from the `IQueue` interface. This method returns a `LocalQueueStats` object that holds local queue statistics.

Below is an example code where the `getLocalQueueStats()` method and the `getAvgAge` method from `LocalQueueStats` get the average age of items.

```
HazelcastInstance node = Hazelcast.newHazelcastInstance();
IQueue<Integer> orders = node.getQueue( "orders" );
LocalQueueStats queueStatistics = orders.getLocalQueueStats();
System.out.println( "average age of items = "
    + queueStatistics.getAvgAge() );
```

The following are some of the metrics that you can access via the `LocalQueueStats` object.

- Number of owned items in the member (`getOwnedItemCount()`).
- Number of backup items in the member (`getBackupItemCount()`).
- Minimum and maximum ages of the items in the member (`getMinAge()` and `getMaxAge()`).
- Number of offer, put and add operations (`getOfferOperationCount()`).

Please refer to [LocalQueueStats Javadoc](#) to see all the metrics.

### 18.1.6. Topic Statistics

To get local topic statistics, use the `getLocalTopicStats()` method from the `ITopic` interface. This method returns a `LocalTopicStats` object that holds local topic statistics.

Below is an example code where the `getLocalTopicStats()` method and the `getPublishOperationCount` method from `LocalTopicStats` get the number of publish operations.

```
HazelcastInstance hazelcastInstance = Hazelcast.newHazelcastInstance();
ITopic<Object> news = hazelcastInstance.getTopic( "news" );
LocalTopicStats topicStatistics = news.getLocalTopicStats();
System.out.println( "number of publish operations = "
    + topicStatistics.getPublishOperationCount() );
```

The following are the metrics that you can access via the `LocalTopicStats` object.

- Creation time of the topic on the member (`getCreationTime()`).
- Total number of published messages of the topic on the member (`getPublishOperationCount()`).
- Total number of received messages of the topic on the member (`getReceiveOperationCount()`).

Please refer to [here](#) for its Javadoc.

### 18.1.7. Executor Statistics

To get local executor statistics, use the `getLocalExecutorStats()` method from the `IExecutorService` interface. This method returns a `LocalExecutorStats` object that holds local executor statistics.

Below is an example code where the `getLocalExecutorStats()` method and the `getCompletedTaskCount` method from `LocalExecutorStats` get the number of completed operations of the executor service.

```
HazelcastInstance hazelcastInstance = Hazelcast.newHazelcastInstance();
IExecutorService orderProcessor = hazelcastInstance.getExecutorService(
    "orderProcessor" );
LocalExecutorStats executorStatistics = orderProcessor.getLocalExecutorStats();
System.out.println( "completed task count = "
    + executorStatistics.getCompletedTaskCount() );
```

The following are some of the metrics that you can access via the `LocalExecutorStats` object.

- Number of pending operations of the executor service (`getPendingTaskCount()`).
- Number of started operations of the executor service (`getStartedTaskCount()`).
- Number of completed operations of the executor service (`getCompletedTaskCount()`).

Please refer to [LocalExecutorStats Javadoc](#) to see all the metrics.

## 18.2. JMX API per Member

Hazelcast members expose various management beans which include statistics about distributed data structures and the states of Hazelcast member internals.

The metrics are local to the members, i.e., they do not reflect cluster wide values.

You can find the JMX API definition below with descriptions and the API methods in parenthesis.

### Atomic Long ( `IAtomicLong` )

- Name ( `name` )
- Current Value ( `currentValue` )
- Set Value ( `set(v)` )
- Add value and Get ( `addAndGet(v)` )
- Compare and Set ( `compareAndSet(e,v)` )
- Decrement and Get ( `decrementAndGet()` )
- Get and Add ( `getAndAdd(v)` )
- Get and Increment ( `getAndIncrement()` )
- Get and Set ( `getAndSet(v)` )
- Increment and Get ( `incrementAndGet()` )
- Partition key ( `partitionKey` )

### Atomic Reference ( `IAtomicReference` )

- Name ( `name` )
- Partition key ( `partitionKey` )

### Countdown Latch ( `ICountDownLatch` )

- Name ( `name` )
- Current count ( `count` )
- Countdown ( `countDown()` )
- Partition key ( `partitionKey` )

### Executor Service ( `IExecutorService` )

- Local pending operation count ( `localPendingTaskCount` )
- Local started operation count ( `localStartedTaskCount` )
- Local completed operation count ( `localCompletedTaskCount` )
- Local cancelled operation count ( `localCancelledTaskCount` )
- Local total start latency ( `localTotalStartLatency` )

- Local total execution latency ( `localTotalExecutionLatency` )

### List ( `IList` )

- Name ( `name` )
- Clear list ( `clear` )

### Lock ( `ILock` )

- Name ( `name` )
- Lock Object ( `lockObject` )
- Partition key ( `partitionKey` )

### Map ( `IMap` )

- Name ( `name` )
- Size ( `size` )
- Config ( `config` )
- Owned entry count ( `localOwnedEntryCount` )
- Owned entry memory cost ( `localOwnedEntryMemoryCost` )
- Backup entry count ( `localBackupEntryCount` )
- Backup entry cost ( `localBackupEntryMemoryCost` )
- Backup count ( `localBackupCount` )
- Creation time ( `localCreationTime` )
- Last access time ( `localLastAccessTime` )
- Last update time ( `localLastUpdateTime` )
- Hits ( `localHits` )
- Locked entry count ( `localLockedEntryCount` )
- Dirty entry count ( `localDirtyEntryCount` )
- Put operation count ( `localPutOperationCount` )
- Get operation count ( `localGetOperationCount` )
- Remove operation count ( `localRemoveOperationCount` )
- Total put latency ( `localTotalPutLatency` )
- Total get latency ( `localTotalGetLatency` )
- Total remove latency ( `localTotalRemoveLatency` )
- Max put latency ( `localMaxPutLatency` )
- Max get latency ( `localMaxGetLatency` )
- Max remove latency ( `localMaxRemoveLatency` )
- Event count ( `localEventOperationCount` )

- Other (keySet,entrySet etc..) operation count ( `localOtherOperationCount` )
- Total operation count ( `localTotal` )
- Heap Cost ( `localHeapCost` )
- Clear ( `clear()` )
- Values ( `values(p)` )
- Entry Set ( `entrySet(p)` )

### MultiMap ( `MultiMap` )

- Name ( `name` )
- Size ( `size` )
- Owned entry count ( `localOwnedEntryCount` )
- Owned entry memory cost ( `localOwnedEntryMemoryCost` )
- Backup entry count ( `localBackupEntryCount` )
- Backup entry cost ( `localBackupEntryMemoryCost` )
- Backup count ( `localBackupCount` )
- Creation time ( `localCreationTime` )
- Last access time ( `localLastAccessTime` )
- Last update time ( `localLastUpdateTime` )
- Hits ( `localHits` )
- Locked entry count ( `localLockedEntryCount` )
- Put operation count ( `localPutOperationCount` )
- Get operation count ( `localGetOperationCount` )
- Remove operation count ( `localRemoveOperationCount` )
- Total put latency ( `localTotalPutLatency` )
- Total get latency ( `localTotalGetLatency` )
- Total remove latency ( `localTotalRemoveLatency` )
- Max put latency ( `localMaxPutLatency` )
- Max get latency ( `localMaxGetLatency` )
- Max remove latency ( `localMaxRemoveLatency` )
- Event count ( `localEventOperationCount` )
- Other (keySet,entrySet etc..) operation count ( `localOtherOperationCount` )
- Total operation count ( `localTotal` )
- Clear ( `clear()` )

### Replicated Map ( `ReplicatedMap` )



- Name ( `name` )
- Size ( `size` )
- Config ( `config` )
- Owned entry count ( `localOwnedEntryCount` )
- Creation time ( `localCreationTime` )
- Last access time ( `localLastAccessTime` )
- Last update time ( `localLastUpdateTime` )
- Hits ( `localHits` )
- Put operation count ( `localPutOperationCount` )
- Get operation count ( `localGetOperationCount` )
- Remove operation count ( `localRemoveOperationCount` )
- Total put latency ( `localTotalPutLatency` )
- Total get latency ( `localTotalGetLatency` )
- Total remove latency ( `localTotalRemoveLatency` )
- Max put latency ( `localMaxPutLatency` )
- Max get latency ( `localMaxGetLatency` )
- Max remove latency ( `localMaxRemoveLatency` )
- Event count ( `localEventOperationCount` )
- Replication event count ( `localReplicationEventCount` )
- Other (keySet,entrySet etc..) operation count ( `localOtherOperationCount` )
- Total operation count ( `localTotal` )
- Clear ( `clear()` )
- Values ( `values()` )
- Entry Set ( `entrySet()` )

## Queue ( `IQueue` )

- Name ( `name` )
- Config ( `QueueConfig` )
- Partition key ( `partitionKey` )
- Owned item count ( `localOwnedItemCount` )
- Backup item count ( `localBackupItemCount` )
- Minimum age ( `localMinAge` )
- Maximum age ( `localMaxAge` )
- Average age ( `localAveAge` )
- Offer operation count ( `localOfferOperationCount` )

- Rejected offer operation count ( `localRejectedOfferOperationCount` )
- Poll operation count ( `localPollOperationCount` )
- Empty poll operation count ( `localEmptyPollOperationCount` )
- Other operation count ( `localOtherOperationsCount` )
- Event operation count ( `localEventOperationCount` )
- Clear ( `clear()` )

### **Semaphore ( `ISemaphore` )**

- Name ( `name` )
- Available permits ( `available` )
- Partition key ( `partitionKey` )
- Drain ( `drain()` )
- Shrink available permits by given number ( `reduce(v)` )
- Release given number of permits ( `release(v)` )

### **Set ( `ISet` )**

- Name ( `name` )
- Partition key ( `partitionKey` )
- Clear ( `clear()` )

### **Topic ( `ITopic` )**

- Name ( `name` )
- Config ( `config` )
- Creation time ( `localCreationTime` )
- Publish operation count ( `localPublishOperationCount` )
- Receive operation count ( `localReceiveOperationCount` )

### **Hazelcast Instance ( `HazelcastInstance` )**

- Name ( `name` )
- Version ( `version` )
- Build ( `build` )
- Configuration ( `config` )
- Configuration source ( `configSource` )
- Group name ( `groupName` )
- Network Port ( `port` )
- Cluster-wide Time ( `clusterTime` )

- Size of the cluster ( `memberCount` )
- List of members ( `Members` )
- Running state ( `running` )
- Shutdown the member ( `shutdown()` )
- **Node ( `HazelcastInstance.Node` )**
- Address ( `address` )
- Master address ( `masterAddress` )
- **Event Service ( `HazelcastInstance.EventService` )**
  - Event thread count ( `eventThreadCount` )
  - Event queue size ( `eventQueueSize` )
  - Event queue capacity ( `eventQueueCapacity` )
- **Operation Service ( `HazelcastInstance.OperationService` )**
  - Response queue size ( `responseQueueSize` )
  - Operation executor queue size ( `operationExecutorQueueSize` )
  - Running operation count ( `runningOperationsCount` )
  - Remote operation count ( `remoteOperationCount` )
  - Executed operation count ( `executedOperationCount` )
  - Operation thread count ( `operationThreadCount` )
- **Proxy Service ( `HazelcastInstance.ProxyService` )**
  - Proxy count ( `proxyCount` )
- **Partition Service ( `HazelcastInstance.PartitionService` )**
  - Partition count ( `partitionCount` )
  - Active partition count ( `activePartitionCount` )
  - Cluster Safe State ( `isClusterSafe` )
  - LocalMember Safe State ( `isLocalMemberSafe` )
- **Connection Manager ( `HazelcastInstance.ConnectionManager` )**
  - Client connection count ( `clientConnectionCount` )
  - Active connection count ( `activeConnectionCount` )
  - Connection count ( `connectionCount` )
- **Client Engine ( `HazelcastInstance.ClientEngine` )**
  - Client endpoint count ( `clientEndpointCount` )
- **System Executor ( `HazelcastInstance.ManagedExecutorService` )**
  - Name ( `name` )
  - Work queue size ( `queueSize` )
  - Thread count of the pool ( `poolSize` )

- Maximum thread count of the pool ( `maximumPoolSize` )
- Remaining capacity of the work queue ( `remainingQueueCapacity` )
- Is shutdown ( `isShutdown` )
- Is terminated ( `isTerminated` )
- Completed task count ( `completedTaskCount` )
- **Async Executor ( `HazelcastInstance.ManagedExecutorService` )**
  - Name ( `name` )
  - Work queue size ( `queueSize` )
  - Thread count of the pool ( `poolSize` )
  - Maximum thread count of the pool ( `maximumPoolSize` )
  - Remaining capacity of the work queue ( `remainingQueueCapacity` )
  - Is shutdown ( `isShutdown` )
  - Is terminated ( `isTerminated` )
  - Completed task count ( `completedTaskCount` )
- **Scheduled Executor ( `HazelcastInstance.ManagedExecutorService` )**
  - Name ( `name` )
  - Work queue size ( `queueSize` )
  - Thread count of the pool ( `poolSize` )
  - Maximum thread count of the pool ( `maximumPoolSize` )
  - Remaining capacity of the work queue ( `remainingQueueCapacity` )
  - Is shutdown ( `isShutdown` )
  - Is terminated ( `isTerminated` )
  - Completed task count ( `completedTaskCount` )
- **Client Executor ( `HazelcastInstance.ManagedExecutorService` )**
  - Name ( `name` )
  - Work queue size ( `queueSize` )
  - Thread count of the pool ( `poolSize` )
  - Maximum thread count of the pool ( `maximumPoolSize` )
  - Remaining capacity of the work queue ( `remainingQueueCapacity` )
  - Is shutdown ( `isShutdown` )
  - Is terminated ( `isTerminated` )
  - Completed task count ( `completedTaskCount` )
- **Query Executor ( `HazelcastInstance.ManagedExecutorService` )**
  - Name ( `name` )
  - Work queue size ( `queueSize` )

- Thread count of the pool ( `poolSize` )
- Maximum thread count of the pool ( `maximumPoolSize` )
- Remaining capacity of the work queue ( `remainingQueueCapacity` )
- Is shutdown ( `isShutdown` )
- Is terminated ( `isTerminated` )
- Completed task count ( `completedTaskCount` )
- **IO Executor ( `HazelcastInstance.ManagedExecutorService` )**
  - Name ( `name` )
  - Work queue size ( `queueSize` )
  - Thread count of the pool ( `poolSize` )
  - Maximum thread count of the pool ( `maximumPoolSize` )
  - Remaining capacity of the work queue ( `remainingQueueCapacity` )
  - Is shutdown ( `isShutdown` )
  - Is terminated ( `isTerminated` )
  - Completed task count ( `completedTaskCount` )

## 18.3. Monitoring with JMX

You can monitor your Hazelcast members via the JMX protocol.

To achieve this, first add the following system properties to enable [JMX agent](#):

- `-Dcom.sun.management.jmxremote`
- `-Dcom.sun.management.jmxremote.port=_portNo\_\_` (to specify JMX port, the default is `1099`) **(optional)**
- `-Dcom.sun.management.jmxremote.authenticate=false` (to disable JMX auth) **(optional)**

Then enable the Hazelcast property `hazelcast.jmx` (please refer to the [System Properties appendix](#)) using one of the following ways:

- By declarative configuration:

```
<properties>
  <property name="hazelcast.jmx">true</property>
</properties>
```

- By programmatic configuration:

```
config.setProperty("hazelcast.jmx", "true");
```

- By Spring XML configuration:

```
<hz:properties>
  <hz: property name="hazelcast.jmx">true</hz:property>
</hz:properties>
```

- By setting the system property `-Dhazelcast.jmx=true`

### 18.3.1. MBean Naming for Hazelcast Data Structures

Hazelcast set the naming convention for MBeans as follows:

```
final ObjectName mapMBeanName = new ObjectName(
    "com.hazelcast:instance=_hzInstance_1_dev,type=IMap,name=trial");
```

The MBeans name consists of the Hazelcast instance name, the type of the data structure and that data structure's name. In the above sample, `_hzInstance_1_dev` is the instance name, we connect to an IMap with the name `trial`.

### 18.3.2. Connecting to JMX Agent

One of the ways you can connect to JMX agent is using `jconsole`, `jvisualvm` (with MBean plugin) or another JMX compliant monitoring tool.

The other way to connect is to use a custom JMX client.

First, you need to specify the URL where the Hazelcast JMX service is running. Please see the following sample code snippet. The `port` in this sample should be the one that you define while setting the JMX remote port number (if different than the default port `1099`).

```
// Parameters for connecting to the JMX Service
int port = 1099;
String hostname = InetAddress.getLocalHost().getHostName();
JMXServiceURL url = new JMXServiceURL("service:jmx:rmi://" + hostname + ":" + port +
    "/jndi/rmi://" + hostname + ":" + port + "/jmxrmi");
```

Then use the URL you acquired to connect to the JMX service and get the `JMXConnector` object. Using this object, get the `MBeanServerConnection` object. The `MBeanServerConnection` object will enable you to use the MBean methods. Please see the example code below.

```
// Connect to the JMX Service
JMXConnector jmx = JMXConnectorFactory.connect(url, null);
MBeanServerConnection mbsc = jmx.getMBeanServerConnection();
```

Once you get the `MBeanServerConnection` object, you can call the getter methods of MBeans as follows:

```
System.out.println("\nTotal entries on map " + mbsc.getAttribute(mapMBeanName, "name")
+ " : "
                + mbsc.getAttribute(mapMBeanName, "localOwnedEntryCount"));
```

## 18.4. Cluster Utilities

This section provides information on programmatic utilities you can use to listen to the cluster events, to change the state of your cluster, to check whether the cluster and/or members are safe before shutting down a member and to define the minimum number of cluster members required for the cluster to remain up and running. It also gives information on the Hazelcast Lite Member.

### 18.4.1. Getting Member Events and Member Sets

Hazelcast allows you to register for membership events so you will be notified when members are added or removed. You can also get the set of cluster members.

The following example code does the above: registers for member events, notifies when members are added or removed and gets the set of cluster members.

```
public class SampleGetMemberEventsAndSets {

    public static void main(String[] args) {
        HazelcastInstance hazelcastInstance = Hazelcast.newHazelcastInstance();
        Cluster cluster = hazelcastInstance.getCluster();
        cluster.addMembershipListener( new MembershipListener() {
            public void memberAdded( MembershipEvent membershipEvent ) {
                System.out.println( "MemberAdded " + membershipEvent );
            }

            public void memberRemoved( MembershipEvent membershipEvent ) {
                System.out.println( "MemberRemoved " + membershipEvent );
            }
        } );

        Member localMember = cluster.getLocalMember();
        System.out.println( "my inetAddress= " + localMember.getInetAddress() );

        Set setMembers = cluster.getMembers();
        for ( Member member : setMembers ) {
            System.out.println( "isLocalMember " + member.getLocalMember() );
            System.out.println( "member.inetAddress " + member.getInetAddress() );
            System.out.println( "member.port " + member.getPort() );
        }
    }
}
```



Please refer to the [Membership Listener section](#) for more information on membership events.

## 18.4.2. Managing Cluster and Member States

Starting with Hazelcast 3.6, Hazelcast introduces cluster and member states in addition to the default **ACTIVE** state. This section explains these states of Hazelcast clusters and members which you can use to allow or restrict the designated cluster/member operations.

### Cluster States

By changing the state of your cluster, you can allow/restrict several cluster operations or change the behavior of those operations. You can use the methods `changeClusterState()` and `shutdown()` which are in the [Cluster interface](#) to change your cluster's state.

Hazelcast clusters have the following states:

- **ACTIVE:** This is the default cluster state. Cluster continues to operate without restrictions.
- **NO\_MIGRATION:**
  - In this state, migrations (partition rebalancing) and backup replications are not allowed. In other words, there will be no data movement between Hazelcast members. However, in case of member failures, backup replicas can be still promoted to the primaries to maintain availability and migration listeners can be notified for these promotion migrations. Please note that promoting a backup replica to the primary replica is a local operation and does not transfer partition data between Hazelcast members.
  - The cluster accepts new members.
  - All other operations are allowed.
  - You cannot change the state of a cluster to **NO\_MIGRATION** when migration/replication tasks are being performed.
  - When you want to add multiple new members to the cluster, you can first change the cluster state to **NO\_MIGRATION**, then start the new members. Once all of them join to the cluster, you can change the cluster state back to **ACTIVE**. Then, the cluster will rebalance partition replica distribution at once.
- **FROZEN:**
  - In this state, the partition table is frozen and partition assignments are not performed.
  - The cluster does not accept new members.
  - If a member leaves, it can join back. Its partition assignments (both primary and backup replicas) remain the same until either it joins back or the cluster state is changed to **ACTIVE**. When it joins back to the cluster, it will own all previous partition assignments as it was. On the other hand, when the cluster state changes to **ACTIVE**, re-partitioning starts and unassigned partition replicas are assigned to the active members.
  - All other operations in the cluster, except migration, continue without restrictions.
  - You cannot change the state of a cluster to **FROZEN** when migration/replication tasks are being



performed.

- You can make use of **FROZEN** state along with the [Hot Restart Persistence](#) feature. You can change the cluster state to **FROZEN**, then restart some of your members using the Hot Restart feature. The data on the restarting members will not be accessible but you will be able to access to the data that is stored in other members. Basically, **FROZEN** cluster state allows you do perform maintenance on your members with degrading availability partially.
- **PASSIVE:**
  - In this state, the partition table is frozen and partition assignments are not performed.
  - The cluster does not accept new members.
  - If a member leaves while the cluster is in this state, the member will be removed from the partition table if cluster state moves back to **ACTIVE**.
  - This state rejects ALL operations immediately EXCEPT the read-only operations like `map.get()` and `cache.get()`, replication and cluster heartbeat tasks.
  - You cannot change the state of a cluster to **PASSIVE** when migration/replication tasks are being performed.
  - You can make use of **PASSIVE** state along with the [Hot Restart Persistence](#) feature. Please see [Cluster Shutdown API](#) for more info.
- **IN\_TRANSITION:**
  - This state shows that the state of the cluster is in transition.
  - You cannot set your cluster's state as **IN\_TRANSITION** explicitly.
  - It is a temporary and intermediate state.
  - During this state, your cluster does not accept new members and migration/replication tasks are paused.



All in-cluster methods are fail-fast, i.e., when a method fails in the cluster, it throws an exception immediately (it will not be retried).

The following snippet is from the **Cluster** interface showing the methods used to manage your cluster's states.

```
public interface Cluster {  
    ...  
    ...  
    ClusterState getClusterState();  
    void changeClusterState(ClusterState newState);  
    void changeClusterState(ClusterState newState, TransactionOptions  
transactionOptions);  
    void shutdown();  
    void shutdown(TransactionOptions transactionOptions);  
}
```

Please refer to the [Cluster interface](#) for information on these methods.

## Cluster Member States

Hazelcast cluster members have the following states:

- **ACTIVE**: This is the initial member state. The member can execute and process all operations. When the state of the cluster is **ACTIVE** or **FROZEN**, the members are in the **ACTIVE** state.
- **PASSIVE**: In this state, member rejects all operations EXCEPT the read-only ones, replication and migration operations, heartbeat operations and the join operations as explained in the [Cluster States section](#) above. A member can go into this state when either of the following happens:
  1. Until the member's shutdown process is completed after the method `Node.shutdown(boolean)` is called. Note that, when the shutdown process is completed, member's state changes to **SHUT\_DOWN**.
  2. Cluster's state is changed to **PASSIVE** using the method `changeClusterState()`.
- **SHUT\_DOWN**: A member goes into this state when the member's shutdown process is completed. The member in this state rejects all operations and invocations. A member in this state cannot be restarted.

### 18.4.3. Using the Script `cluster.sh`

You can use the script `cluster.sh`, which comes with the Hazelcast package, to get/change the state of your cluster, to shutdown your cluster and to force your cluster to clean its persisted data and make a fresh start. The latter is the Force Start operation of Hazelcast's Hot Restart Persistence feature. Please refer to the [Force Start section](#).



The script `cluster.sh` uses `curl` command and `curl` must be installed to be able to use the script.

The script `cluster.sh` needs the following parameters to operate according to your needs. If these parameters are not provided, the default values are used.

Parameter	Default Value	Description
<code>-o</code> or <code>--operation</code>	<code>get-state</code>	Executes a cluster-wide operation. Operations can be the following: <ul style="list-style-type: none"><li>• IMDG Open Source operations: <code>get-state</code>, <code>change-state</code>, <code>shutdown</code> and <code>get-cluster-version</code>.</li><li>• IMDG Enterprise operations: <code>force-start</code>, <code>partial-start</code> and <code>change-cluster-version</code>.</li></ul>
<code>-s</code> or <code>--state</code>	None	Updates the state of the cluster to a new state. New state can be <code>active</code> , <code>no_migration</code> , <code>frozen</code> , <code>passive</code> . This is used with the operation <code>change-state</code> . This parameter has no default value; when you use this, you should provide a valid state.

Parameter	Default Value	Description
<code>-a</code> or <code>--address</code>	<code>127.0.0.1</code>	Defines the IP address of a cluster member. If you want to manage your cluster remotely, you should use this parameter to provide the IP address of a member to this script.
<code>-p</code> or <code>--port</code>	<code>5701</code>	Defines on which port Hazelcast is running on the local or remote machine. Its default value is <code>5701</code> .
<code>-g</code> or <code>--groupname</code>	<code>dev</code>	Defines the name of a cluster group which is used for a simple authentication. Please see the <a href="#">Creating Cluster Groups section</a> .
<code>-P</code> or <code>--password</code>	<code>dev-pass</code>	Defines the password of a cluster group (valid only for Hazelcast releases older than 3.8.2). Please see the <a href="#">Creating Cluster Groups section</a> .
<code>-v</code> or <code>--version</code>	None	Defines the cluster version to change to. To be used in conjunction with <code>change-cluster-version</code> operation.

The script `cluster.sh` is self-documented; you can see the parameter descriptions using the command `sh cluster.sh -h` or `sh cluster.sh --help`.



You can perform the above operations using the Hot Restart tab of Hazelcast Management Center or using the REST API. Please see the [Hot Restart](#) and [Using REST API for Cluster Management](#).

### Example Usages for `cluster.sh`

Let's say you have a cluster running on remote machines and one Hazelcast member is running on the IP `172.16.254.1` and on the port `5702`. The group name and password of the cluster are `test` and `test`.

#### Getting the cluster state:

To get the state of the cluster, use the following command:

```
sh cluster.sh -o get-state -a 172.16.254.1 -p 5702 -g test -P test
```

The following also gets the cluster state, using the alternative parameter names, e.g., `--port` instead of `-p`:

```
sh cluster.sh --operation get-state --address 172.16.254.1 --port 5702 --groupname test --password test
```

#### Changing the cluster state:

To change the state of the cluster to `frozen`, use the following command:

```
sh cluster.sh -o change-state -s frozen -a 172.16.254.1 -p 5702 -g test -P test
```

Similarly, you can use the following command for the same purpose:

```
sh cluster.sh --operation change-state --state frozen --address 172.16.254.1 --port 5702 --groupname test --password test
```

### **Shutting down the cluster:**

To shutdown the cluster, use the following command:

```
sh cluster.sh -o shutdown -a 172.16.254.1 -p 5702 -g test -P test
```

Similarly, you can use the following command for the same purpose:

```
sh cluster.sh --operation shutdown --address 172.16.254.1 --port 5702 --groupname test --password test
```

### **Partial starting the cluster:**

To partial start the cluster when Hot Restart is enabled, use the following command:

```
sh cluster.sh -o partial-start -a 172.16.254.1 -p 5702 -g test -P test
```

Similarly, you can use the following command for the same purpose:

```
sh cluster.sh --operation partial-start --address 172.16.254.1 --port 5702 --groupname test --password test
```

### **Force starting the cluster:**

To force start the cluster when Hot Restart is enabled, use the following command:

```
sh cluster.sh -o force-start -a 172.16.254.1 -p 5702 -g test -P test
```

Similarly, you can use the following command for the same purpose:

```
sh cluster.sh --operation force-start --address 172.16.254.1 --port 5702 --groupname test --password test
```

### **Getting the current cluster version:**

To get the cluster version, use the following command:

```
sh cluster.sh -o get-cluster-version -a 172.16.254.1 -p 5702 -g test -P test
```

The following also gets the cluster state, using the alternative parameter names, e.g., `--port` instead of `-p`:

```
sh cluster.sh --operation get-cluster-version --address 172.16.254.1 --port 5702 --groupname test --password test
```

### **Changing cluster version:**

Learn more about when you should change the cluster version in [Rolling Member Upgrades chapter](#).

To change the cluster version to 3.9, use the following command:

```
sh cluster.sh -o change-cluster-version -v 3.9 -a 172.16.254.1 -p 5702 -g test -P test
```

Cluster version is always in `major.minor` format, using other formats will result in a failure.



Currently, this script is not supported on the Windows platforms.

#### 18.4.4. Using REST API for Cluster Management

Besides the Management Center's Hot Restart `tab` and the script `cluster.sh`, you can also use REST API to manage your cluster's state. The following are the operations you can perform.

Table 4. REST API calls

##### IMDG Open Source commands

- *Getting the cluster state:*

To get the state of the cluster, use the following command:

```
curl --data "${GROUPNAME}&${PASSWORD}" http
://127.0.0.1:5701/hazelcast/rest/management/cluster/state
```

- *Changing the cluster state:*

To change the state of the cluster to `frozen`, use the following command:

```
curl --data "${GROUPNAME}&${PASSWORD}&${STATE}" http
://127.0.0.1:${PORT}/hazelcast/rest/management/cluster/changeState
```

- *Shutting down the cluster:*

To shutdown the cluster, use the following command:

```
curl --data "${GROUPNAME}&${PASSWORD}" http
://127.0.0.1:${PORT}/hazelcast/rest/management/cluster/clusterShutdown
```

- *Querying the current cluster version:*

To get the current cluster version, use the following `curl` command:

```
$ curl http://127.0.0.1:${PORT}/hazelcast/rest/management/cluster/version
{"status":"success","version":"3.9"}
```

## IMDG Enterprise commands

- *Partial starting the cluster:*

To partial start the cluster when Hot Restart is enabled, use the following command:

```
curl --data "${GROUPNAME}&${PASSWORD}" http
://127.0.0.1:${PORT}/hazelcast/rest/management/cluster/partialStart/
```

- *Force starting the cluster:*

To force start the cluster when Hot Restart is enabled, use the following command:

```
curl --data "${GROUPNAME}&${PASSWORD}" http
://127.0.0.1:${PORT}/hazelcast/rest/management/cluster/forceStart/
```



You can also perform the above operations (partialStart and forceStart) using the Hot Restart tab of Hazelcast Management Center or using the script `cluster.sh`. Please see the [Hot Restart](#) and `cluster.sh`.

- *Initiating Hot Backup:*

To initiate the Hot Backup, use the following `curl` command:

```
curl --data "${GROUPNAME}&${PASSWORD}" http
://127.0.0.1:${PORT}/hazelcast/rest/management/cluster/hotBackup
```

- *Changing the cluster version:*

To upgrade the cluster version, after having upgraded all members of your cluster to a new minor version, use the following `curl` command:

```
$ curl --data "${GROUPNAME}&${PASSWORD}&${CLUSTER_VERSION}" http
://127.0.0.1:${PORT}/hazelcast/rest/management/cluster/version
```

For example, assuming the default group name and password, issue the following command to any member of the cluster to upgrade from cluster version 3.8 to 3.9:

```
$ curl --data "dev&dev-pass&3.9" http
://127.0.0.1:5701/hazelcast/rest/management/cluster/version
{"status":"success","version":"3.9"}
```

## 18.4.5. Enabling Lite Members

You can also perform the above cluster version operations using Hazelcast Management Center or using the script `cluster.sh`. Please see the [Rolling Member Upgrades](#) and `cluster.sh`. Lite members are the Hazelcast cluster members that do not store data. These members are used mainly to execute tasks and register listeners and they do not have partitions.

You can form your cluster to include the regular Hazelcast members to store data and Hazelcast lite members to run heavy computations. The presence of the lite members do not affect the operations performed on the other members in the cluster. You can directly submit your tasks to the lite members, register listeners on them and invoke operations for the Hazelcast data structures on them such as `map.put()` and `map.get()`.

### Configuring Lite Members

You can enable a cluster member to be a lite member using declarative or programmatic configuration.

#### Declarative Configuration:

```
<hazelcast>
  <lite-member enabled="true">
</hazelcast>
```

#### Programmatic Configuration:

```
Config config = new Config();
config.setLiteMember(true);
```

### Promoting Lite Members to Data Member

Lite members can be promoted to data members using the `Cluster` interface. When they are promoted, cluster partitions are rebalanced and ownerships of some portion of the partitions are assigned to the newly promoted data members.

```
Config config = new Config();
config.setLiteMember(true);

HazelcastInstance hazelcastInstance = Hazelcast.newHazelcastInstance(config);
Cluster cluster = hazelcastInstance.getCluster();
cluster.promoteLocalLiteMember();
```



A data member cannot be downgraded to a lite member back.

## 18.4.6. Defining Member Attributes

You can define various member attributes on your Hazelcast members. You can use these member attributes to tag your members as your business logic requirements.

To define member attribute on a member, you can either:

- provide `MemberAttributeConfig` to your `Config` object,
- or provide member attributes at runtime via attribute setter methods on the `Member` interface.

For example, you can tag your members with their CPU characteristics and you can route CPU intensive tasks to those CPU-rich members:

```
public class SampleMemberAttributes {

    public static void main(String[] args) {
        MemberAttributeConfig fourCore = new MemberAttributeConfig();
        memberAttributeConfig.setIntAttribute( "CPU_CORE_COUNT", 4 );
        MemberAttributeConfig twelveCore = new MemberAttributeConfig();
        memberAttributeConfig.setIntAttribute( "CPU_CORE_COUNT", 12 );
        MemberAttributeConfig twentyFourCore = new MemberAttributeConfig();
        memberAttributeConfig.setIntAttribute( "CPU_CORE_COUNT", 24 );

        Config member1Config = new Config();
        config.setMemberAttributeConfig( fourCore );
        Config member2Config = new Config();
        config.setMemberAttributeConfig( twelveCore );
        Config member3Config = new Config();
        config.setMemberAttributeConfig( twentyFourCore );

        HazelcastInstance member1 = Hazelcast.newHazelcastInstance( member1Config );
        HazelcastInstance member2 = Hazelcast.newHazelcastInstance( member2Config );
        HazelcastInstance member3 = Hazelcast.newHazelcastInstance( member3Config );

        IExecutorService executorService = member1.getExecutorService( "processor" );

        executorService.execute( new CPUIntensiveTask(), new MemberSelector() {
            @Override
            public boolean select(Member member) {
                int coreCount = (int) member.getIntAttribute( "CPU_CORE_COUNT" );
                // Task will be executed at either member2 or member3
                if ( coreCount > 8 ) {
                    return true;
                }
                return false;
            }
        } );

        HazelcastInstance member4 = Hazelcast.newHazelcastInstance();
        // We can also set member attributes at runtime.
        member4.setIntAttribute( "CPU_CORE_COUNT", 2 );
    }
}
```



For another example, you can tag some members with a filter so that a member in the cluster can load classes from those tagged members. Please see the [User Code Deployment section](#) for more information.

You can also configure your member attributes through declarative configuration and start your member afterwards. Here is how you can use the declarative approach:

```
<member-attributes>
  <attribute name="CPU_CORE_COUNT">4</attribute-name>
</member-attributes>
```

### 18.4.7. Safety Checking Cluster Members

To prevent data loss when shutting down a cluster member, Hazelcast provides a graceful shutdown feature. You perform this shutdown by calling the method `HazelcastInstance.shutdown()`.

Starting with Hazelcast 3.7, the master member migrates all of the replicas owned by the shutdown-requesting member to the other running (not initiated shutdown) cluster members. After these migrations are completed, the shutting down member will not be the owner or a backup of any partition anymore. It means that you can shutdown any number of Hazelcast members in a cluster concurrently with no data loss.

Please note that the process of shutting down members waits for a predefined amount of time for the master to migrate their partition replicas. You can specify this graceful shutdown timeout duration using the property `hazelcast.graceful.shutdown.max.wait`. Its default value is 10 minutes. If migrations are not completed within this duration, shutdown may continue non-gracefully and lead to data loss. Therefore, you should choose your own timeout duration considering the size of data in your cluster.

#### Ensuring Safe State with PartitionService

With the improvements in graceful shutdown procedure in Hazelcast 3.7, the following methods are not needed to perform graceful shutdown. Nevertheless, you can use them to check the current safety status of the partitions in your cluster.

```
public interface PartitionService {
    ...
    ...
    boolean isClusterSafe();
    boolean isMemberSafe(Member member);
    boolean isLocalMemberSafe();
    boolean forceLocalMemberToBeSafe(long timeout, TimeUnit unit);
}
```

The method `isClusterSafe` checks whether the cluster is in a safe state. It returns `true` if there are no active partition migrations and all backups are in sync for each partition.

The method `isMemberSafe` checks whether a specific member is in a safe state. It checks if all

backups of partitions of the given member are in sync with the primary ones. Once it returns `true`, the given member is safe and it can be shut down without data loss.

Similarly, the method `isLocalMemberSafe` does the same check for the local member. The method `forceLocalMemberToBeSafe` forces the owned and backup partitions to be synchronized, making the local member safe.



If you want to use the above methods, please note that they are available starting with Hazelcast 3.3.



For more code samples please refer to [PartitionService Code Samples](#).

## 18.5. Diagnostics

Starting with Hazelcast 3.7, Hazelcast offers an extended set of diagnostics plugins for both Hazelcast members and clients. A dedicated log file is used to write the diagnostics content, and a rolling file approach is used to prevent taking up too much disk space.

### 18.5.1. Enabling Diagnostics Logging

To enable diagnostics logging, you should specify the following properties on the member side:

```
-Dhazelcast.diagnostics.enabled=true
-Dhazelcast.diagnostics.metric.level=info
-Dhazelcast.diagnostics.invocation.sample.period.seconds=30
-Dhazelcast.diagnostics.pending.invocations.period.seconds=30
-Dhazelcast.diagnostics.slowoperations.period.seconds=30
-Dhazelcast.diagnostics.storelatency.period.seconds=60
```

At the client side you should specify the following properties:

```
-Dhazelcast.diagnostics.enabled=true
-Dhazelcast.diagnostics.metric.level=info
```

### 18.5.2. Diagnostics Log File

You can use the following property to specify the location of the diagnostics log file:

```
-Dhazelcast.diagnostics.directory=/your/log/directory
```

The name of the log file has the following format:

```
diagnostics-<host IP>#<port>-<unique ID>.log
```

The name of the log file can be prefixed with a custom string as shown below:

```
-Dhazelcast.diagnostics.filename.prefix=foobar
```

The content format of the diagnostics log file is depicted below:

```
<Date> BuildInfo[
  <log content for BuildInfo diagnostics plugin>]
<Date> SystemProperties[
  <log content for SystemProperties diagnostics plugin>]
<Date> ConfigProperties[
  <log content for ConfigProperties diagnostics plugin>]
<Date> Metrics[
  <log content for Metrics diagnostics plugin>]
<Date> SlowOperations[
  <log content for SlowOperations diagnostics plugin>]
<Date> HazelcastInstance[
  <log content for HazelcastInstance diagnostics plugin>]
...
...
...
```

A rolling file approach is used to prevent creating too much data. By default 10 files of 50MB each are allowed to exist. The size of the file can be changed using the following property:

```
-Dhazelcast.diagnostics.max.rolled.file.size.mb=100
```

You can also set the number of files using the following property:

```
-Dhazelcast.diagnostics.max.rolled.file.count=5
```

In Hazelcast 3.9 the default file size has been upgraded from 10MB to 50MB.

### 18.5.3. Diagnostics Plugins

As it is stated in the introduction of this section and shown in the log file content above, diagnostics utility consists of plugins such as BuildInfo, SystemProperties and HazelcastInstance.

#### BuildInfo

It shows the detailed Hazelcast build information including the Hazelcast release number, [Git](#) revision number and whether you have Hazelcast IMDG Enterprise or not.

#### SystemProperties

It shows all the properties and their values in your system used by and configured for your

Hazelcast installation. These are the properties starting with `java` (excluding `java.awt`), `hazelcast`, `sun` and `os`. It also includes the arguments that are used to startup the JVM.

## ConfigProperties

It shows the Hazelcast properties and their values explicitly set by you either on the command line (with `-D`) or by using declarative/programmatic configuration.

## Metrics

It shows a comprehensive log of what is happening in your Hazelcast system.

You can configure the level of detail and frequency of dumping information to the log file using the following properties:

- `hazelcast.diagnostics.metrics.period.seconds`: Set a value in seconds. Its default value is `60` seconds.
- `hazelcast.diagnostics.metrics.level`: Set a level. It can be `Mandatory`, `Info` and `Debug`. Its default value is `Mandatory`.

## SlowOperations

It shows the slow operations and invocations, Please refer to [SlowOperationDetector](#) for more information.

## Invocations

It shows all kinds of statistics about current and past invocations including current pending invocations, history of invocations and slow history, i.e. all samples where the invocation took more than the defined threshold. Slow history does not only include the invocations where the operations took a lot of time, but it also includes any other invocations that have been obstructed.

Using the following properties, you can configure the frequency of scanning all pending invocations and the threshold that makes an invocation to be considered as slow:

- `hazelcast.diagnostics.invocation.sample.period.seconds`: Set a value in seconds. Its default value is `60` seconds.
- `hazelcast.diagnostics.invocation.slow.threshold.seconds`: Set a value in seconds. Its default value is `5` seconds.

## HazelcastInstance

It shows the basic state of your Hazelcast cluster including the count and addresses of current members and the address of master member. It is useful to get a fast impression of the cluster without needing to analyze a lot of data.

You can configure the frequency at which the cluster information is dumped to the log file using the following property:

- `hazelcast.diagnostics.memberinfo.period.second`: Set a value in seconds. Its default value is `60`

seconds.

## SystemLog

It shows the activities in your cluster including when a connection/member is added or removed and if there is a change in the lifecycle of the cluster. It also includes the reasons for connection closings.

You can enable or disable the system log diagnostics plugin, and configure whether it shows information about partition migrations using the following properties:

- `hazelcast.diagnostics.systemlog.enabled`: Its default value is `true`.
- `hazelcast.diagnostics.systemlog.partitions`: Its default value is `false`. Please note that if you enable this, you may get a lot of log entries if you have many partitions.

## StoreLatency

It shows statistics including the count of methods for each store (`load`, `loadAll`, `loadAllKeys`, etc.), average and maximum latencies for each store method calls and latency distributions for each store. The following is an example output snippet as part of the diagnostics log file for Hazelcast MapStore:

```
17-9-2016 13:12:34 MapStoreLatency[
  map[
    loadAllKeys[
      count=1
      totalTime(us)=8
      avg(us)=8
      max(us)=8
      latency-distribution[
        0..99us=1]]
    load[
      count=100
      totalTime(us)=4,632,190
      avg(us)=46,321
      max(us)=99,178
      latency-distribution[
        0..99us=1
        1600..3199us=3
        3200..6399us=3
        6400..12799us=7
        12800..25599us=13
        25600..51199us=32
        51200..102399us=41]]]]]
```

According to your store usage, a similar output can be seen for Hazelcast JCache, Queue and Ringbuffer with persistent datastores.

You can control the StoreLatency plugin using the following properties:

- `hazelcast.diagnostics.storeLatency.period.seconds`: The frequency this plugin is writing the collected information to the disk. By default it is disabled. A sensible production value would be 60 seconds.
- `hazelcast.diagnostics.storeLatency.reset.period.seconds`: The period of resetting the statistics. If, for example, it is set as 300 (5 minutes), all the statistics are cleared for every 5 minutes. By default it is 0, meaning that statistics are not reset.

## OperationHeartbeats

It shows the deviation between member/member operation heartbeats. Every member will send to every other member, regardless if there is an operation running on behalf of that member, an operation heartbeat. It contains a listing of all `callId`s of the running operations from a given member. This plugin also works fine between members/lite-members.

Because this operation heartbeat is sent periodically; by default 1/4 of the operation call timeout of 60 seconds, we would expect an operation heartbeat to be received every 15 seconds. Operation heartbeats are high priority packets (so they overtake regular packets) and are processed by an isolated thread in the invocation monitor. If there is any deviation in the frequency of receiving these packets, it may be due to the problems such as network latencies.

The following shows an example of the output where an operation heartbeat has not been received for 37 seconds:

```
20-7-2017 11:12:55 OperationHeartbeats[
  member[10.212.1.119]:5701[
    deviation(%)=146.6666717529297
    noHeartbeat(ms)=37,000
    lastHeartbeat(ms)=1,500,538,375,603
    lastHeartbeat(date-time)=20-7-2017 11:12:55
    now(ms)=1,500,538,338,603
    now(date-time)=20-7-2017 11:12:18]]]
```

The OperationHeartbeats plugin is enabled by default since it has very little overhead and will only print to the diagnostics file if the max-deviation (explained below) is exceeded.

You can control the OperationHeartbeats plugin using the following properties:

- `hazelcast.diagnostics.operation-heartbeat.seconds`: The frequency this plugin is writing the collected information to the disk. It is configured to be 10 seconds by default. 0 disables the plugin.
- `hazelcast.diagnostics.operation-heartbeat.max-deviation-percentage`: The maximum allowed deviation percentage. Its default value is 33. For example, with a default 60 call timeout and operation heartbeat interval being 15 seconds, the maximum deviation with a deviation-percentage of 33, is 5 seconds. So there is no problem if a packet is arrived after 19 seconds, but if it arrives after 21 seconds, then the plugin will render.

## MemberHeartbeats

This plugin looks a lot like the OperationHeartbeats plugin, but instead of relying on operation heartbeats to determine the deviation, it relies on member/member cluster heartbeats. Every member will send a heartbeat to every other member periodically (by default every 5 seconds).

Just like the OperationHeartbeats, the MemberHeartbeats plugin can be used to detect if there are networking problems long before they actually lead to problems such as split-brain syndromes.

The following shows an example of the output where no member/member heartbeat has been received for 9 seconds:

```
20-7-2017 19:32:22 MemberHeartbeats[
  member[10.212.1.119]:5701[
    deviation(%)=80.0
    noHeartbeat(ms)=9,000
    lastHeartbeat(ms)=1,500,568,333,645
    lastHeartbeat(date-time)=20-7-2017 19:32:13
    now(ms)=1,500,568,342,645
    now(date-time)=20-7-2017 19:32:22]]
```

The MemberHeartbeats plugin is enabled by default since it has very little overhead and will only print to the diagnostics file if the max-deviation (explained below) is exceeded.

You can control the MemberHeartbeats plugin using the following properties:

- `hazelcast.diagnostics.member-heartbeat.seconds`: The frequency this plugin is writing the collected information to the disk. It is configured to be 10 seconds by default. 0 disables the plugin.
- `hazelcast.diagnostics.member-heartbeat.max-deviation-percentage`: The maximum allowed deviation percentage. Its default value is 100. For example, if the interval of member/member heartbeats is 5 seconds, a 100% deviation will be fine with heartbeats arriving up to 5 seconds after they are expected. So a heartbeat arriving after 9 seconds will not be rendered, but a heartbeat received after 11 seconds will be rendered.

## OperationThreadSamples

This plugin samples the operation threads and checks the running operations/tasks. Hazelcast has the [slow operation detector](#) which is useful for very slow operations. But it may not be efficient for high volumes of not too slow operations. Using the OperationThreadSamples plugin it is more clear to see which operations are actually running.

You can control the OperationThreadSamples plugin using the following properties:

- `hazelcast.diagnostics.operationthreadsamples.period.seconds`: The frequency this plugin is writing the collected information to the disk. An efficient value for production would be 30, 60 or more seconds. 0, which is the default value, disables the plugin.
- `hazelcast.diagnostics.operationthreadsamples.sampler.period.millis`: The period in milliseconds between taking samples. The lower the value, the higher the overhead but also the

higher the precision. Its default value is 100 ms.

- `hazelcast.diagnostics.operationthreadsamples.includeName`: Specifies whether the data structures' name pointed to by the operation (if available) should be included in the name of the samples. Its default value is false.

The following shows an example of the output when the property `hazelcast.diagnostics.operationthreadsamples.includeName` is false:

```
28-08-2018 07:40:07 1535442007330 OperationThreadSamples[
  Partition[
    com.hazelcast.map.impl.operation.MapSizeOperation=304623
85.6927%
    com.hazelcast.map.impl.operation.PutOperation=33061 9.300304%
    com.hazelcast.map.impl.operation.GetOperation=17799 5.0069904
%]
  Generic[
    com.hazelcast.client.impl.ClientEngineImpl
$PriorityPartitionSpecificRunnable=2308 35.738617%
    com.hazelcast.nio.Packet=1767 27.361412%
    com.hazelcast.internal.cluster.impl.operations.JoinRequestOp
=821 12.712914%
    com.hazelcast.spi.impl.operationsservice.impl.operations
.PartitionIteratingOperation=278 4.3047385%
    com.hazelcast.internal.cluster.impl.operations.HeartbeatOp=93
1.4400743%
    com.hazelcast.internal.cluster.impl.operations.OnJoinOp=89
1.3781357%
    com.hazelcast.internal.cluster.impl.operations.WhoisMasterOp
=75 1.1613503%
    com.hazelcast.client.impl.operations.ClientReAuthOperation=33
0.51099414%]]
```

As can be seen above, the `MapSizeOperations` run on the operation threads most of the time.

## WanDiagnostics

The WAN diagnostics plugin provides information about the WAN replication.

It is disabled by default and can be configured using the following property:

- `hazelcast.diagnostics.wan.period.seconds`: The frequency this plugin is writing the collected information to the disk. 0 disables the plugin.

The following shows an example of the output:



```

10-11-2017 14:11:32 1510319492497 WanBatchSenderLatency[
  targetClusterGroupName[
    [127.0.0.1]:5801[
      count=1
      totalTime(us)=2,010,567
      avg(us)=2,010,567
      max(us)=2,010,567
      latency-distribution[
        1638400..3276799us=1]]
    [127.0.0.1]:5802[
      count=1
      totalTime(us)=1,021,867
      avg(us)=1,021,867
      max(us)=1,021,867
      latency-distribution[
        819200..1638399us=1]]]]]

```

## 18.6. Health Check and Monitoring

Hazelcast provides the HTTP-based Health Check endpoint, Health Check script and Health Monitoring utility.

### 18.6.1. Health Check

This is Hazelcast's HTTP based health check implementation which provides basic information about your cluster and member (on which it is launched).

First, you need to enable the health check. To do this, set the `hazelcast.http.healthcheck.enabled` system property to `true`. By default, it is `false`.

Now you retrieve information about your cluster's health status (member state, cluster state, cluster size, etc.) by launching `http://<your member's host IP>:5701/hazelcast/health` on your preferred browser.

An example output is given below:

```

Hazelcast::NodeState=ACTIVE
Hazelcast::ClusterState=ACTIVE
Hazelcast::ClusterSafe=TRUE
Hazelcast::MigrationQueueSize=0
Hazelcast::ClusterSize=2

```

Please refer to the [Managing Cluster and Member States section](#) to learn more about each state of a Hazelcast cluster and member.

## 18.6.2. Health Check Script

The `healthcheck.sh` script comes with the Hazelcast package. Internally, it uses the HTTP-based Health Check endpoint and that is why you also need to set the `hazelcast.http.healthcheck.enabled` system property to `true`.

You can use the script to check health parameters in the following manner:

```
$ ./healthcheck.sh <parameters>
```

The following parameters can be used:

- `-o, --operation`: Health check operation. It can be `all`, `node-state`, `cluster-state`, `cluster-safe`, `migration-queue-size` and `cluster-size`.
- `-a, --address`: Defines which IP address Hazelcast member is running on. Its default value is `127.0.0.1`.
- `-p, --port`: Defines which port Hazelcast member is running on. Its default value is `5701`.
- `-h, --help`: Lists the parameter descriptions along with a usage example.

### *Example 1: Checking Member State of a Healthy Cluster:*

Assuming the member is deployed under the address `127.0.0.1:5701` and it is in the healthy state, the following output is expected:

```
$ ./healthcheck.sh -a 127.0.0.1 -p 5701 -o node-state  
ACTIVE
```

### *Example 2: Checking Safety of a Non-Existing Cluster:*

Assuming there is no member running under the address `127.0.0.1:5701`, the following output is expected:

```
$ ./healthcheck.sh -a 127.0.0.1 -p 5701 -o cluster-safe  
Error while checking health of hazelcast cluster on ip 127.0.0.1 on port 5701.  
Please check that cluster is running and that health check is enabled (property set to  
true: 'hazelcast.http.healthcheck.enabled' or 'hazelcast.rest.enabled').
```

## 18.6.3. Health Monitor

Health monitor periodically prints logs in your console to provide information about your member's state. By default, it is enabled when you start your cluster.

You can set the interval of health monitoring using the `hazelcast.health.monitoring.delay.seconds` system property. Its default value is 30 seconds.

The system property `hazelcast.health.monitoring.level` is used to configure the monitoring's log

level. If it is set to OFF, the monitoring will be disabled. If it is set to NOISY, monitoring logs are always printed for the defined intervals. When it is SILENT, which is the default value, monitoring logs are printed only when the values exceed some predefined thresholds. These thresholds are related to memory and CPU percentages, and can be configured using the `hazelcast.health.monitoring.threshold.memory.percentage` and `hazelcast.health.monitoring.threshold.cpu.percentage` system properties, whose default values are both 70.

The following is an example monitoring output

```
Sep 08, 2017 5:02:28 PM com.hazelcast.internal.diagnostics.HealthMonitor

INFO: [192.168.2.44]:5701 [host-name] [3.9] processors=4, physical.memory.total=16.0G,
physical.memory.free=5.5G, swap.space.total=0, swap.space.free=0, heap.memory.used
=102.4M,

heap.memory.free=249.1M, heap.memory.total=351.5M, heap.memory.max=3.6G, heap.memory
.used/total=29.14%, heap.memory.used/max=2.81%, minor.gc.count=4, minor.gc.time=68ms,
major.gc.count=1,

major.gc.time=41ms, load.process=0.44%, load.system=1.00%, load.systemAverage=315.48%,
thread.count=97, thread.peakCount=98, cluster.timeDiff=0, event.q.size=0, executor.q
.async.size=0,

executor.q.client.size=0, executor.q.query.size=0, executor.q.scheduled.size=0,
executor.q.io.size=0, executor.q.system.size=0, executor.q.operations.size=0,

executor.q.priorityOperation.size=0, operations.completed.count=226, executor.q
.mapLoad.size=0, executor.q.mapLoadAllKeys.size=0, executor.q.cluster.size=0,
executor.q.response.size=0,

operations.running.count=0, operations.pending.invocations.percentage=0.00%,
operations.pending.invocations.count=0, proxy.count=0, clientEndpoint.count=1,

connection.active.count=2, client.connection.count=1, connection.count=1
```



Please see the [Configuring with System Properties section](#) to learn how to set system properties.

#### 18.6.4. Using Health Check on F5 BIG-IP LTM

The F5® BIG-IP® Local Traffic Manager™ (LTM) can be used as a load balancer for Hazelcast cluster members. This section describes how you can configure a health monitor to check the Hazelcast member states.

##### Monitor Types

Following types of monitors can be used to track Hazelcast cluster members:

- **HTTP Monitor:** A custom HTTP monitor enables you to send a command to Hazelcast’s Health Check API using HTTP requests. This is a good choice if SSL/TLS is not enabled in your cluster.
- **HTTPS Monitor:** A custom HTTPS monitor enables you to verify the health of Hazelcast cluster members by sending a command to Hazelcast’s Health Check API using Secure Socket Layer (SSL) security. This is a good choice if SSL/TLS is enabled in your cluster.
- **TCP\\_HALF\\_OPEN Monitor:** A TCP\\_HALF\\_OPEN monitor is a very basic monitor that only checks that the TCP port used by Hazelcast is open and responding to connection requests. It does not interact with the Hazelcast Health Check API. The TCP\\_HALF\\_OPEN monitor can be used with or without SSL/TLS.

## Configuration

After signing in to the BIG-IP LTM User Interface, follow F5’s [instructions](#) to create a new monitor. Next, apply the following configuration according to your monitor type.

### HTTP/HTTPS Monitors



Please note that you should enable the Hazelcast health check for HTTP/HTTPS monitors to run. To do this, set the `hazelcast.http.healthcheck.enabled` system property to true. By default, it is false.

### Using a GET request:

- Set the “Send String” as follows:

```
GET /hazelcast/health HTTP/1.1\r\n\r\nHost: [HOST-ADDRESS-OF-HAZELCAST-MEMBER] \r\n\r\nConnection: Close\r\n\r\n
```

- Set the “Receive String” as follows:

```
Hazelcast::NodeState=ACTIVE\nHazelcast::ClusterState=ACTIVE\nHazelcast::ClusterSafe=TRUE\nHazelcast::MigrationQueueSize=0\nHazelcast::ClusterSize=(^[^s]+)\n
```

The BIG-IP LTM monitors accept regular expressions in these strings allowing you to configure them as needed. The example provided above will remain green even if the cluster size changes.

### Using a HEAD request:

- Set the “Send String” as follows:

```
HEAD /hazelcast/health HTTP/1.1\r\n\r\nHost: [HOST-ADDRESS-OF-HAZELCAST-MEMBER] \r\n\r\nConnection: Close\r\n\r\n
```

- Set the “Receive String” as follows:

200 OK

As you can see, the HEAD request only checks for a **200 OK** response. A Hazelcast cluster member will send this status code when it is alive and running without issue. This provides a very basic health check. For increased flexibility, we recommend using the GET request API.

#### TCP\_HALF\_OPEN Monitors

- Set the "Type" as **TCP Half Open**.
- Optionally, set the "Alias Service Port" as the port of Hazelcast cluster member if you want to specify the port in the monitor.

## 18.7. Management Center

Hazelcast Management Center enables you to monitor and manage your cluster members running Hazelcast. In addition to monitoring the overall state of your clusters, you can also analyze and browse your data structures in detail, update map configurations and take thread dumps from members. You can run scripts (JavaScript, Groovy, etc.) and commands on your members with its scripting and console modules.

Please refer to [Hazelcast Management Center Documentation](#) for its usage details.

### 18.7.1. Toggle Scripting Support

The support for script execution is enabled in the Hazelcast IMDG Open Source edition and disabled in the Hazelcast IMDG Enterprise edition by default. The reason is security. Script engines allow to access the underlying system on the members (files and other resources). Scripts access the system, on which the member runs, with permissions of the running user.

The scripting can be allowed or prevented by specifying the `hazelcast.mancenter.scripting.enabled` system property within Hazelcast the member configuration file, under the `properties` element:

```
<properties>
  <property name="hazelcast.mancenter.scripting.enabled">>false</property>
</properties>
```



This property only works in patch releases for Hazelcast IMDG 3.11 (starting with 3.11.1). The feature is controlled by the `scripting-enabled` attribute of the `management-center` element from Hazelcast IMDG 3.12 onward.

## 18.8. Clustered JMX and REST via Management Center

### Hazelcast IMDG Enterprise

Please refer to [Hazelcast Management Center Documentation](#) for information on Clustered JMX and

Clustered REST (via Management Center) features.

## 19. Security

### Hazelcast IMDG Enterprise Feature

This chapter describes the security features of Hazelcast. These features allow you to perform security activities, such as intercepting socket connections and remote operations executed by the clients, encrypting the communications between the members at socket level and using SSL socket communication. All of the Security features explained in this chapter are the features of Hazelcast IMDG Enterprise edition.

### 19.1. Enabling JAAS Security

With Hazelcast's extensible, JAAS based security feature, you can:

- authenticate both cluster members and clients,
- and perform access control checks on client operations. Access control can be done according to endpoint principal and/or endpoint address.

You can enable security declaratively or programmatically, as shown below.

```
<hazelcast xsi:schemaLocation="http://www.hazelcast.com/schema/config
  http://www.hazelcast.com/schema/config/hazelcast-config-3.9.xsd"
  xmlns="http://www.hazelcast.com/schema/config"
  xmlns:xsi="http://www.w3.org/2001/XMLSchema-instance">

  ...

  <security enabled="true">
    ...
  </security>
</hazelcast>
```

```
Config cfg = new Config();
SecurityConfig securityCfg = cfg.getSecurityConfig();
securityCfg.setEnabled( true );
```

Also, see the [Setting License Key section](#) for information on how to set your Hazelcast IMDG Enterprise license.

### 19.2. Socket Interceptor

#### Hazelcast IMDG Enterprise Feature

Hazelcast allows you to intercept socket connections before a member joins a cluster or a client

connects to a member of a cluster. This allow you to add custom hooks to join and perform connection procedures (like identity checking using Kerberos, etc.).

To use the socket interceptor, implement `com.hazelcast.nio.MemberSocketInterceptor` for members and `com.hazelcast.nio.SocketInterceptor` for clients.

The following is an example socket interceptor implementation for the member side.

```
public static class MySocketInterceptor implements MemberSocketInterceptor {

    private String memberId;

    public MySocketInterceptor() {
    }

    @Override
    public void onAccept(Socket socket) throws IOException {
        socket.getOutputStream().write(memberId.getBytes());
        byte[] bytes = new byte[1024];
        int len = socket.getInputStream().read(bytes);
        String otherMemberId = new String(bytes, 0, len);
        if (!otherMemberId.equals("secondMember")) {
            throw new RuntimeException("Not a known member!!!");
        }
    }

    @Override
    public void init(Properties properties) {
        memberId = properties.getProperty("member-id");
    }

    @Override
    public void onConnect(Socket socket) throws IOException {
        socket.getOutputStream().write(memberId.getBytes());
        byte[] bytes = new byte[1024];
        int len = socket.getInputStream().read(bytes);
        String otherMemberId = new String(bytes, 0, len);
        if (!otherMemberId.equals("firstMember")) {
            throw new RuntimeException("Not a known member!!!");
        }
    }
}
```

You can declaratively configure this socket interceptor as follows:

```

<hazelcast>
  ...
  <network>
    ...
    <socket-interceptor enabled="true">
      <class-name>com.hazelcast.examples.MySocketInterceptor</class-name>
      <properties>
        <property name="kerberos-host">kerb-host-name</property>
        <property name="kerberos-config-file">kerb.conf</property>
      </properties>
    </socket-interceptor>
  </network>
  ...
</hazelcast>

```

The following is an example configuration of the above socket interceptor for the client side.

```

public static void main(String[] args) {

    Config config = createConfig();
    Hazelcast.newHazelcastInstance(config);

    ClientConfig clientConfig = createClientConfig();
    HazelcastClient.newHazelcastClient(clientConfig);
}

private static Config createConfig() {
    Config config = new Config();
    //config.setLicenseKey(ENTERPRISE_LICENSE_KEY);
    config.setProperty("hazelcast.wait.seconds.before.join", "0");

    SocketInterceptorConfig interceptorConfig = new SocketInterceptorConfig();
    interceptorConfig.setEnabled(true).setClassName(MySocketInterceptor.class.getName());
    config.getNetworkConfig().setSocketInterceptorConfig(interceptorConfig);

    return config;
}

private static ClientConfig createClientConfig() {
    ClientConfig clientConfig = new ClientConfig();
    //clientConfig.setLicenseKey(ENTERPRISE_LICENSE_KEY);
    SocketInterceptorConfig interceptorConfig = new SocketInterceptorConfig();
    interceptorConfig.setEnabled(true).setClassName(MySocketInterceptor.class.getName());
    clientConfig.getNetworkConfig().setSocketInterceptorConfig(interceptorConfig);
    return clientConfig;
}

```



## 19.3. Security Interceptor

### Hazelcast IMDG Enterprise Feature

Hazelcast allows you to intercept every remote operation executed by the client. This lets you add a very flexible custom security logic. To do this, implement `com.hazelcast.security.SecurityInterceptor`.

```
private static class MySecurityInterceptor implements SecurityInterceptor {

    @Override
    public void before(Credentials credentials, String objectType, String objectName,
String methodName,
        Parameters parameters) throws AccessControlException {
        if (objectName.equals(DENIED_MAP_NAME)) {
            throw new RuntimeException("Denied Map!!!");
        }
        if (methodName.equals(DENIED_METHOD)) {
            throw new RuntimeException("Denied Method!!!");
        }
        Object firstParam = parameters.get(0);
        Object secondParam = parameters.get(1);
        if (firstParam.equals(DENIED_KEY)) {
            throw new RuntimeException("Denied Key!!!");
        }
        if (secondParam.equals(DENIED_VALUE)) {
            throw new RuntimeException("Denied Value!!!");
        }
    }

    @Override
    public void after(Credentials credentials, String objectType, String objectName,
String methodName,
        Parameters parameters) {
        System.err.println("qwe c: " + credentials + "\t\tt: " + objectType + "\t\tt: "
+ objectName
            + "\t\tm: " + methodName + "\t\tt1: " + parameters.get(0) + "\t\tt2: "
+ parameters.get(1));
    }
}
```

The `before` method will be called before processing the request on the remote server. The `after` method will be called after the processing. Exceptions thrown while executing the `before` method will propagate to the client, but exceptions thrown while executing the `after` method will be suppressed.

## 19.4. Encryption

### Hazelcast IMDG Enterprise Feature

Hazelcast offers features which allow to reach a required privacy on communication level by enabling encryption. Encryption is based on [Java Cryptography Architecture](#).

There are two different encryption features:

- TLS protocol
  - transport level encryption
  - supported by members and clients
  - TCP-only (i.e. Multicast join messages are not encrypted)
  - Please see the [TLS/SSL section](#) for details.
- Symmetric encryption for Hazelcast member protocol
  - only supported by members; communication with clients is not encrypted
  - Multicast join messages are encrypted too

The preferred and recommended feature is the TLS protocol as it's a standard way how to protect communication on transport level.

Symmetric encryption for Hazelcast member protocol can be configured with cipher algorithms implemented by security providers and accessed through Java Cryptography Architecture. Check documentation of your Java version to learn about supported algorithm names. Some examples:

- AES
- PBESWithMD5AndDES
- DES/ECB/PKCS5Padding
- Blowfish

Hazelcast uses MD5 message-digest algorithm as the cryptographic hash function. You can also use the salting process by giving a salt and password which are then concatenated and processed with MD5, and the resulting output is stored with the salt.

In symmetric encryption, each member uses the same key, so the key is shared. Here is an example configuration for symmetric encryption.

```
<hazelcast>
...
<network>
...
  <symmetric-encryption enabled="true">
    <algorithm>AES</algorithm>
    <salt>thesalt</salt>
    <password>thepass</password>
    <iteration-count>175</iteration-count>
  </symmetric-encryption>
</network>
...
</hazelcast>
```

You set the encryption algorithm, the salt value to use for generating the secret key, the password to use when generating the secret key and the iteration count to use when generating the secret key. You also need to set `enabled` to true. Note that all members should have the same encryption configuration.

## 19.5. TLS/SSL

### Hazelcast IMDG Enterprise Feature



You cannot use TLS/SSL when [Hazelcast Encryption](#) is enabled.

One of the offers of Hazelcast is the SSL (Secure Sockets Layer) protocol which you can use to establish an encrypted communication across your cluster with key stores and trust stores. Note that, if you are developing applications using Java 8, you will be using its successor TLS (Transport Layer Security).



It is NOT recommended to reuse the key stores and trust stores for external applications.

### 19.5.1. TLS/SSL for Hazelcast Members

Hazelcast allows you to encrypt socket level communication between Hazelcast members and between Hazelcast clients and members, for end to end encryption. To use it, you need to implement `com.hazelcast.nio.ssl.SSLContextFactory` and configure the SSL section in the network configuration.

The following is the implementation code snippet:

```
public class MySSLContextFactory implements SSLContextFactory {
    public void init( Properties properties ) throws Exception {
    }

    public SSLContext getSSLContext() {
        ...
        SSLContext sslCtx = SSLContext.getInstance( "the protocol to be used" );
        return sslCtx;
    }
}
```

The following is the base declarative configuration for the implemented `SSLContextFactory`:

```

<hazelcast>
  ...
  <network>
    ...
    <ssl enabled="true">
      <factory-class-name>
        com.hazelcast.examples.MySSLContextFactory
      </factory-class-name>
      <properties>
        <property name="foo">bar</property>
      </properties>
    </ssl>
  </network>
  ...
</hazelcast>

```

Hazelcast provides a default `SSLContextFactory`, `com.hazelcast.nio.ssl.BasicSSLContextFactory`, which uses the configured keystore to initialize `SSLContext`; see the following example configuration for TLS/SSL.

```

<hazelcast>
  ...
  <network>
    ...
    <ssl enabled="true">
      <factory-class-name>
        com.hazelcast.nio.ssl.BasicSSLContextFactory
      </factory-class-name>
      <properties>
        <property name="keyStore">/opt/hazelcast-keystore.p12</property>
        <property name="keyStorePassword">secret.123</property>
        <property name="keyStoreType">PKCS12</property>
        <property name="trustStore">/opt/hazelcast-truststore.p12</property>
        <property name="trustStorePassword">changeit</property>
        <property name="trustStoreType">PKCS12</property>
        <property name="protocol">TLSv1.2</property>
        <property name="mutualAuthentication">REQUIRED</property>
      </properties>
    </ssl>
  </network>
  ...
</hazelcast>

```

Here are the descriptions for the properties:

- `keyStore`: Path of your keystore file.
- `keyStorePassword`: Password to access the key from your keystore file.

- **keyManagerAlgorithm**: Name of the algorithm based on which the authentication keys are provided.
- **keyStoreType**: Type of the keystore. Its default value is **JKS**. Another commonly used type is the **PKCS12**. Available keystore/truststore types depend on your Operating system and the Java runtime.
- **trustStore**: Path of your truststore file. The file truststore is a keystore file that contains a collection of certificates trusted by your application.



When you enable TLS/SSL and do not provide the **trustStore** property, the default trusted certificates are used, i.e., the Java provided list of trusted CA certificates.

- **trustStorePassword**: Password to unlock the truststore file.
- **trustManagerAlgorithm**: Name of the algorithm based on which the trust managers are provided.
- **trustStoreType**: Type of the truststore. Its default value is **JKS**. Another commonly used type is the **PKCS12**. Available keystore/truststore types depend on your Operating system and the Java runtime.
- **mutualAuthentication**: Mutual authentication configuration. It's empty by default which means the client side of connection is not authenticated. Available values are:
  - **REQUIRED** - server forces usage of a trusted client certificate
  - **OPTIONAL** - server asks for a client certificate, but it doesn't require it

Please see the [Mutual Authentication section](#).

- **ciphersuites**: Comma-separated list of cipher suite names allowed to be used. Its default value are all supported suites in your Java runtime.
- **protocol**: Name of the algorithm which is used in your TLS/SSL. Its default value is **TLS**. Available values are:
  - **TLS**
  - **TLSv1**
  - **TLSv1.1** (from Java 8)
  - **TLSv1.2** (from Java 8)
  - **TLSv1.3** (from Java 11)

For the **protocol** property, we recommend you to provide TLS with its version information, e.g., **TLSv1.2**. Note that if you write only **TLS**, your application will choose the TLS version according to your Java version.

## Other Property Configuration Options

You can set all the properties presented in this section as system properties using the **javax.net.ssl** prefix, e.g., **javax.net.ssl.keyStore** and **javax.net.ssl.keyStorePassword**.

See below equivalent examples:

```
System.setProperty("javax.net.ssl.trustStore", "/user/home/hazelcast.ts");
```

Or,

```
-Djavax.net.ssl.trustStore=/user/home/hazelcast.ts
```

This way of TLS/SSL configuration is then system wide in your Java runtime.

## 19.5.2. TLS/SSL for Hazelcast Clients

The TLS configuration in Hazelcast clients is very similar to member configuration.

```
<hazelcast-client>
...
<network>
...
<ssl enabled="true">
  <factory-class-name>
    com.hazelcast.nio.ssl.BasicSSLContextFactory
  </factory-class-name>
  <properties>
    <property name="keyStore">/opt/hazelcast-client.keystore</property>
    <property name="keyStorePassword">clientsSecret</property>
    <property name="trustStore">/opt/hazelcast-client.truststore</property>
    <property name="trustStorePassword">changeit</property>
    <property name="protocol">TLSv1.2</property>
  </properties>
</ssl>
</network>
...
</hazelcast-client>
```

The same `BasicSSLContextFactory` properties used for members are available on clients. Clients don't need to set `mutualAuthentication` property as it's used in configuring the server side of TLS connections.

## 19.5.3. Mutual Authentication

TLS connections have two sides: the one opening the connection (TLS client) and the one accepting the connection (TLS server). By default only the TLS server proves its identity by presenting a certificate to the TLS client. The mutual authentication means that also the TLS clients prove their identity to TLS servers.

Hazelcast members can be on both sides of TLS connection - TLS servers and TLS clients. Hazelcast clients are always on the client side of a TLS connection.

By default Hazelcast members have `keyStore` used to identify themselves to the clients and other

members. Both Hazelcast members and Hazelcast clients have trustStore used to define which members they can trust.

When the mutual authentication feature is enabled, Hazelcast clients need to provide keyStore. A client proves its identity by providing its certificate to Hazelcast member it's connecting to. The member only accepts the connection if the client's certificate is present in the member's trustStore.

To enable mutual authentication, set `mutualAuthentication` property value to `REQUIRED` on member side:

```
Config cfg = new Config();
Properties props = new Properties();

props.setProperty("mutualAuthentication", "REQUIRED");
props.setProperty("keyStore", "/opt/hazelcast.keystore");
props.setProperty("keyStorePassword", "123456");
props.setProperty("trustStore", "/opt/hazelcast.truststore");
props.setProperty("trustStorePassword", "123456");

cfg.getNetworkConfig().setSSLConfig(new SSLConfig().setEnabled(true).setProperties
(props));
Hazelcast.newHazelcastInstance(cfg);
```

And at the client side, you need to set client identity by providing the keystore:

```
clientSslProps.setProperty("keyStore", "/opt/client.keystore");
clientSslProps.setProperty("keyStorePassword", "123456");
```

The property `mutualAuthentication` has two options:

- **REQUIRED**: Server asks for client certificate. If the client does not provide a keystore or the provided keys is not verified against member's truststore, the client will not be authenticated.
- **OPTIONAL**: Server asks for client certificate, but client is not required to provide any valid certificate.



When a new client is introduced with a new keystore, the truststore at the member side should be updated accordingly to include new clients' information to be able to accept it.

Please see the below example snippet to see the full configuration at the client side:

```

ClientConfig config = new ClientConfig();
Properties clientSslProps = new Properties();
clientSslProps.setProperty("keyStore", "/opt/client.keystore");
clientSslProps.setProperty("keyStorePassword", "123456");
clientSslProps.setProperty("trustStore", "/opt/client.truststore");
clientSslProps.setProperty("trustStorePassword", "123456");

config.getNetworkConfig().setSSLConfig(new SSLConfig().setEnabled(true).setProperties
(clientSslProps));
HazelcastClient.newHazelcastClient(config);

```

If the mutual authentication is not required, the Hazelcast members will accept all incoming TLS connections without verifying if the connecting side is trusted. Therefore it's recommended to require the mutual authentication in Hazelcast members configuration.

### 19.5.4. TLS/SSL Performance Improvements for Java

TLS/SSL can have a significant impact on performance. There are a few ways to increase the performance.

The first thing that can be done is making sure that AES intrinsics are used. Modern CPUs (2010 or newer Westmere) have hardware support for AES encryption/decryption and if a Java 8 or newer JVM is used, the JIT will automatically make use of these AES instructions. They can also be explicitly enabled using `-XX:+UseAES -XX:+UseAESIntrinsics`, or disabled using `-XX:-UseAES -XX:-UseAESIntrinsics`.

A lot of encryption algorithms make use of padding because they encrypt/decrypt in fixed sized blocks. If not enough data is available for a block, the algorithm relies on random number generation to pad. Under Linux, the JVM automatically makes use of `/dev/random` for the generation of random numbers. `/dev/random` relies on entropy to be able to generate random numbers. However if this entropy is insufficient to keep up with the rate requiring random numbers, it can slow down the encryption/decryption since `/dev/random` will block; it could block for minutes waiting for sufficient entropy. This can be fixed by adding the following system property `-Djava.security.egd=file:/dev/./urandom`. For a more permanent solution, modify `<JAVA_HOME>/jre/lib/security/java.security` file, look for the `securerandom.source=/dev/urandom` and change it to `securerandom.source=file:/dev/./urandom`. Switching to `/dev/urandom` could be controversial because the `/dev/urandom` will not block if there is a shortage of entropy and the returned random values could theoretically be vulnerable to a cryptographic attack. If this is a concern in your application, use `/dev/random` instead.

Another way to increase performance for the Java smart client is to make use of Hazelcast 3.8. In Hazelcast 3.8, the Java smart client automatically makes use of extra I/O threads for encryption/decryption and this have a significant impact on the performance. This can be changed using the `hazelcast.client.io.input.thread.count` and `hazelcast.client.io.output.thread.count` client system properties. By default it is 1 input thread and 1 output thread. If TLS/SSL is enabled, it will default to 3 input threads and 3 output threads. Having more client I/O threads than members in the cluster will not lead to an increased performance. So with a 2-member cluster, 2 in and 2 out threads will give the best performance.



### 19.5.5. TLS/SSL Debugging

To assist with TLS/SSL issues, the following system property can be used:

```
-Djavax.net.debug=all
```

The property will provide a lot of logging output including the TLS/SSL handshake, that can be used to determine the cause of the problem. For more information please see [Debugging TSL/SSL Connections](#).

### 19.5.6. TLS/SSL for Hazelcast Management Center

In order to use secured communication between cluster and Management Center, you have to configure the cluster, see [Connecting Hazelcast members to Management Center](#).

## 19.6. Integrating OpenSSL / BoringSSL

### Hazelcast IMDG Enterprise Feature



You cannot integrate OpenSSL into Hazelcast when [Hazelcast Encryption](#) is enabled.

TLS/SSL in Java is normally provided by the JRE. However, the performance overhead can be significant; even with AES intrinsics enabled. If you are using a x86\_64 system (Linux, Mac, Windows), Hazelcast supports native integration for TLS/SSL which can provide significant performance improvements. There are two supported native TLS/SSL libraries available through [netty-tcnative](#) libraries:

- OpenSSL
  - dynamically linked;
  - prerequisites: `libapr`, `openssl` packages installed on your system;
- BoringSSL - Google managed fork of the OpenSSL
  - statically linked;
  - easier to get started with;
  - benefits: reduced code footprint, additional features

The native TLS integration can be used on clients and/or members. For best performance, it is recommended to install on a client and member and configure the appropriate cipher suite(s).

Check [netty-tcnative](#) page for installation details.

### 19.6.1. Netty Libraries

For the native TLS/SSL integration in Java, the [Netty](#) library is used.

Make sure the following libraries from the Netty framework are on the classpath:

- `netty-handler` and its dependencies
- one of `tc-native` implementations
  - either BoringSSL: `netty-tcnative-boringssl-static-{tcnative_version}.jar`
  - or OpenSSL: `netty-tcnative-{tcnative_version}-{os_arch}.jar`



It is very important that the version of Netty JAR(s) corresponds to a very specific version of `netty-tcnative`. In case of doubt, the simplest thing to do is to download the `netty-<version>.tar.bz2` file from the [Netty](#) website and check which `netty-tcnative` version is used for that Netty release.

### 19.6.2. Using BoringSSL

The statically linked BoringSSL binaries are included within the `netty-tcnative` libraries. There is no need to install additional software on supported systems.

Example Maven dependencies:

```
<dependencies>
  <dependency>
    <groupId>io.netty</groupId>
    <artifactId>netty-tcnative-boringssl-static</artifactId>
    <version>2.0.12.Final</version>
  </dependency>
  <dependency>
    <groupId>io.netty</groupId>
    <artifactId>netty-handler</artifactId>
    <version>4.1.27.Final</version>
  </dependency>
</dependencies>
```

### 19.6.3. Using OpenSSL

Install OpenSSL. Make sure that you are installing 1.0.1 or newer release. Please refer to its documentation at [github.com/openssl](https://github.com/openssl).

Install Apache Portable Runtime (APR) library. Please refer to [apr.apache.org](https://apr.apache.org).

For RHEL:

```
sudo yum -y install apr openssl
```

For Ubuntu:

```
sudo apt-get -y install libapr1 openssl
```

For Alpine Linux:

```
apk add --update apr openssl
```

Example Maven dependencies (for Linux):

```
<dependencies>
  <dependency>
    <groupId>io.netty</groupId>
    <artifactId>netty-tcnative</artifactId>
    <version>2.0.12.Final</version>
    <classifier>linux-x86_64</classifier>
  </dependency>
  <dependency>
    <groupId>io.netty</groupId>
    <artifactId>netty-handler</artifactId>
    <version>4.1.27.Final</version>
  </dependency>
</dependencies>
```

#### 19.6.4. Configuring Hazelcast for OpenSSL

Configuring OpenSSL in Hazelcast is straight forward. On the client and/or member side, the following snippet enables TLS/SSL using OpenSSL:

```
<network>
  ...
  <ssl enabled="true">
    <factory-class-name>com.hazelcast.nio.ssl.OpenSSLFactory</factory-class-
name>

    <properties>
      <property name="protocol">TLSv1.2</property>
      <property name="trustCertCollectionFile">trusted-certs.pem</property>
      <!-- If the TLS mutual authentication is not used,
         then the key configuration is not needed on client side. -->
      <property name="keyFile">privkey.pem</property>
      <property name="keyCertChainFile">chain.pem</property>
    </properties>
  </ssl>
</network>
```

The configuration is similar to a regular TLS/SSL integration. The main difference is the `OpenSSLFactory` factory class and following new properties:

- `keyFile`: Path of your PKCS#8 key file in PEM format.
- `keyPassword`: Password to access the key file when it's encrypted.
- `keyCertChainFile`: Path to an X.509 certificate chain file in PEM format.
- `trustCertCollectionFile`: Path to an X.509 certificate collection file in PEM format.

These new properties take precedence over `keyStore` and `trustStore` configurations. Using `keyStores`

and trustStores together with OpenSSL causes problems on some Java versions, therefore we recommend to use the OpenSSL native way.

Other supported properties are:

- **keyStore**: Path of your keystore file.
  - *Using the **keyStore** property is not recommended, use **keyFile** and **keyCertChainFile** instead*
- **keyStorePassword**: Password to access the key from your keystore file.
- **keyStoreType**: Type of the keystore. Its default value is **JKS**. Another commonly used type is the **PKCS12**. Available keystore/truststore types depend on your Operating system and the Java runtime.
- **keyManagerAlgorithm**: Name of the algorithm based on which the authentication keys are provided.
- **trustManagerAlgorithm**: Name of the algorithm based on which the trust managers are provided.
- **trustStore**: Path of your truststore file. The file truststore is a keystore file that contains a collection of certificates trusted by your application. Its type should be **JKS**.
  - *Using the **trustStore** property is not recommended, use **trustCertCollectionFile** instead*
- **trustStorePassword**: Password to unlock the truststore file.
- **trustStoreType**: Type of the truststore. Its default value is **JKS**. Another commonly used type is the **PKCS12**. Available keystore/truststore types depend on your Operating system and the Java runtime.
- **ciphersuites**: Comma-separated list of cipher suite names allowed to be used.
- **protocol**: Name of the algorithm which is used in your TLS/SSL. Its default value is **TLSv1.2**. Available values are:
  - **TLS**
  - **TLSv1**
  - **TLSv1.1**
  - **TLSv1.2**
  - **SSL (insecure!)**
  - **SSLv2 (insecure!)**
  - **SSLv3 (insecure!)**

All of the algorithms listed above support Java 6 and higher versions. For the **protocol** property, we recommend you to provide SSL or TLS with its version information, e.g., **TLSv1.2**. Note that if you provide only **SSL** or **TLS** as a value for the **protocol** property, they will be converted to **SSLv3** and **TLSv1.2**, respectively. We strongly recommend to avoid SSL protocols.

### 19.6.5. Configuring Cipher Suites

To get the best performance, the correct **cipher suites** need to be configured. Each cipher suite has different performance and security characteristics and depending on the hardware and selected

cipher suite, the overhead of TLS can range from dramatic to almost negligible.

The cipher suites are configured using the `ciphersuites` property as shown below:

```
<ssl enabled="true">
  <factory-class-name>...</factory-class-name>

  <properties>
    <property name="keyStore">upload/hazelcast.keystore</property>
    ...
    <property name="ciphersuites">TLS_ECDHE_RSA_WITH_AES_128_CBC_SHA256,
      TLS_ECDH_RSA_WITH_3DES_EDE_CBC_SHA</property>
  </properties>
</ssl>
```

The `ciphersuites` property accepts a comma separated list (spaces, enters, tabs are filtered out) of cipher suites in the order of preference.

You can configure a member and client with different cipher suites; but there should be at least one shared cipher suite.

One of the cipher suites that gave very low overhead but still provides solid security is the 'TLS\_ECDHE\_RSA\_WITH\_AES\_128\_GCM\_SHA256'. However in our measurements this cipher suite only performs well using OpenSSL; using the regular Java TLS integration, it performs badly. So keep that in mind when configuring a client using regular SSL and a member using OpenSSL.

Please check with your security expert to determine which cipher suites are appropriate and run performance tests to see which ones perform well in your environment.

If you don't configure the cipher suites, then both client and/or member will determine a cipher suite by themselves during the TLS/SSL handshake. This can lead to suboptimal performance and lower security than required.

### 19.6.6. Other Ways of Configuring Properties

You can set all the properties presented in this section using the `javax.net.ssl` prefix, e.g., `javax.net.ssl.keyStore` and `javax.net.ssl.keyStorePassword`.

Also note that these properties can be specified using the related Java system properties and also Java's `-D` command line option. This is very useful if you require a more flexible configuration e.g. when doing performance tests.

See below examples equivalent to each other:

```
System.setProperty("javax.net.ssl.trustStore", "/user/home/hazelcast.ts");
```

Or,

```
-Djavax.net.ssl.trustStore=/user/home/hazelcast.ts
```

Another two examples equivalent to each other:

```
System.setProperty("javax.net.ssl.ciphersuites",  
"TLS_ECDHE_RSA_WITH_AES_128_CBC_SHA256,TLS_ECDH_RSA_WITH_3DES_EDE_CBC_SHA");
```

Or,

```
-Djavax.net.ssl.ciphersuites=TLS_ECDHE_RSA_WITH_AES_128_CBC_SHA256  
,TLS_ECDH_RSA_WITH_3DES_EDE_CBC_SHA
```

## 19.7. Credentials

### Hazelcast IMDG Enterprise Feature

One of the key elements in Hazelcast security is the `Credentials` object, which carries all credentials of an endpoint (member or client). `Credentials` is an interface which extends `Serializable`. You can either implement the three methods in the `Credentials` interface, or you can extend the `AbstractCredentials` class, which is an abstract implementation of `Credentials`.

Hazelcast calls the `Credentials.setEndpoint()` method when an authentication request arrives at the member before authentication takes place. Here are the methods of `Credentials` interface (see its [Javadoc](#)):

```
public interface Credentials extends Serializable {  
    String getEndpoint();  
    void setEndpoint( String endpoint ) ;  
    String getPrincipal() ;  
}
```

Here is the snippet from the abstract implementation of `Credentials` (see its [Javadoc](#)):

```
public abstract class AbstractCredentials implements Credentials, DataSerializable {  
    private transient String endpoint;  
    private String principal;  
    ...  
}
```

`UsernamePasswordCredentials`, a custom implementation of `Credentials`, is in the Hazelcast `com.hazelcast.security` package. `UsernamePasswordCredentials` is used for default configuration during the authentication process of both members and clients.

```
public class UsernamePasswordCredentials extends Credentials {
    private byte[] password;
    ...
}
```

## 19.8. Validating Secrets Using Strength Policy

### Hazelcast IMDG Enterprise Feature

Hazelcast IMDG Enterprise offers a secret validation mechanism including a strength policy. The term "secret" here refers to the symmetric encryption password, salt and other passwords and keys.

For this validation, Hazelcast IMDG Enterprise comes with the class `DefaultSecretStrengthPolicy` to identify all possible weaknesses of secrets and to display a warning in the system logger. Note that, by default, no matter how weak the secrets are, the cluster members will still start after logging this warning; however, this is configurable (please see the “Enforcing the Secret Strength Policy” section).

Requirements (rules) for the secrets are as follows:

- Minimum length of eight characters; and
- Large keyspace use, ensuring the use of at least three of the following:
  - mixed case;
  - alpha;
  - numerals;
  - special characters; and
  - no dictionary words.

The rules “Minimum length of eight characters” and “no dictionary words” can be configured using the following system properties:

`hazelcast.security.secret.policy.min.length`: Set the minimum secret length. The default is 8 characters.

Example:

```
-Dhazelcast.security.secret.policy.min.length=10
```

`hazelcast.security.dictionary.policy.wordlist.path`: Set the path of a wordlist available in the file system. The default is `/usr/share/dict/words`.

Example:

```
-Dhazelcast.security.dictionary.policy.wordlist.path="/Desktop/myWordList"
```

### 19.8.1. Using a Custom Secret Strength Policy

You can implement `SecretStrengthPolicy` to develop your custom strength policy for a more flexible or strict security. After you implement it, you can use the following system property to point to your custom class:

`hazelcast.security.secret.strength.default.policy.class`: Set the full name of the custom class.

Example:

```
-Dhazelcast.security.secret.strength.default.policy.class="com.impl.myStrengthPolicy"
```

### 19.8.2. Enforcing the Secret Strength Policy

By default, secret strength policy is NOT enforced. This means, if a weak secret is detected, an informative warning will be showed in the system logger and the members will continue to initialize. However, you can enforce the policy using the following system property so that the members will not be started until the weak secret errors are fixed:

`hazelcast.security.secret.strength.policy.enforced`: Set to “true” to enforce the secret strength policy. The default is “false”. To enforce:

```
-Dhazelcast.security.secret.strength.policy.enforced=true
```

The following is a sample warning when secret strength policy is NOT enforced, i.e., the above system property is set to “false”:

```
@@@@@@@@@@@@@@@@@@@@@@@@@@@@@@@@@@@@ SECURITY WARNING @@@@@@@@@@@@@@@@@@@@@@@@@@@@@@@@@@
Group password does not meet the current policy and complexity requirements.
*Must not be set to the default.
@@@@@@@@@@@@@@@@@@@@@@@@@@@@@@@@@@@@@@@@@@@@@@@@@@@@@@@@@@@@@@@@@@@@@@@@@@@@@@@@@@@@
```

The following is a sample warning when secret strength policy is enforced, i.e., the above system property is set to “true”:



```

WARNING: [192.168.2.112]:5701 [dev] [3.9-SNAPSHOT]
@@@@@@@@@@@@@@@@@@@@@@@@@@@@@@@@@@@@ SECURITY WARNING @@@@@@@@@@@@@@@@@@@@@@@@@@@@@@@@@
Symmetric Encryption Password does not meet the current policy and complexity
requirements.
*Must contain at least 1 number.
*Must contain at least 1 special character.
Group Password does not meet the current policy and complexity requirements.
*Must not be set to the default.
*Must have at least 1 lower and 1 upper case characters.
*Must contain at least 1 number.
*Must contain at least 1 special character.
Symmetric Encryption Salt does not meet the current policy and complexity
requirements.
*Must contain 8 or more characters.
*Must contain at least 1 number.
*Must contain at least 1 special character.
@@@@@@@@@@@@@@@@@@@@@@@@@@@@@@@@@@@@@@@@@@@@@@@@@@@@@@@@@@@@@@@@@@@@@@@@@@@@@@@@@@@@
Exception in thread "main" com.hazelcast.security.WeakSecretException: Weak secrets
found in configuration, check output above for more details.
at com.hazelcast.security.impl.WeakSecretsConfigChecker.evaluateAndReport
(WeakSecretsConfigChecker.java:49)
at com.hazelcast.instance.EnterpriseNodeExtension.printNodeInfo
(EnterpriseNodeExtension.java:197)
at com.hazelcast.instance.Node.<init>(Node.java:194)
at com.hazelcast.instance.HazelcastInstanceImpl.createNode(HazelcastInstanceImpl.java
:163)
at com.hazelcast.instance.HazelcastInstanceImpl.<init>(HazelcastInstanceImpl.java:130)
at com.hazelcast.instance.HazelcastInstanceFactory.constructHazelcastInstance
(HazelcastInstanceFactory.java:195)
at com.hazelcast.instance.HazelcastInstanceFactory.newHazelcastInstance
(HazelcastInstanceFactory.java:174)
at com.hazelcast.instance.HazelcastInstanceFactory.newHazelcastInstance
(HazelcastInstanceFactory.java:124)
at com.hazelcast.core.Hazelcast.newHazelcastInstance(Hazelcast.java:58)

```

## 19.9. ClusterLoginModule

### Hazelcast IMDG Enterprise Feature

All security attributes are carried in the `Credentials` object. `Credentials` is used by `LoginModule` s during the authentication process. User supplied attributes from `LoginModule` 's are accessed by `CallbackHandler` s. To access the `Credentials` object, Hazelcast uses its own specialized `CallbackHandler`. During initialization of `LoginModules`, Hazelcast passes this special `CallbackHandler` into the `LoginModule.initialize()` method.

Your implementation of `LoginModule` should create an instance of `com.hazelcast.security.CredentialsCallback` and call the `handle(Callback[] callbacks)` method of `CallbackHandler` during the login process.

`CredentialsCallback.getCredentials()` returns the supplied `Credentials` object.

```
public abstract class CustomLoginModule implements LoginModule {

    protected boolean loginSucceeded;
    CallbackHandler callbackHandler;
    Subject subject;
    Credentials credentials;

    public void initialize( Subject subject, CallbackHandler callbackHandler,
                          Map<String, ?> sharedState, Map<String, ?> options ) {
        this.subject = subject;
        this.callbackHandler = callbackHandler;
    }

    public final boolean login() throws LoginException {
        CredentialsCallback callback = new CredentialsCallback();
        try {
            callbackHandler.handle( new Callback[] { callback } );
            credentials = callback.getCredentials();
        } catch ( Exception e ) {
            throw new LoginException( e.getMessage() );
        }
        //...
        return loginSucceeded;
    }
    //...
}
```

To use the default Hazelcast permission policy, you must create an instance of `com.hazelcast.security.ClusterPrincipal` that holds the `Credentials` object and you must add it to `Subject.principals` on `LoginModule.commit()` as shown below.

```
public class MyCustomLoginModule implements LoginModule {

    ...
    public boolean commit() throws LoginException {
        ...
        Principal principal = new ClusterPrincipal( credentials );
        subject.getPrincipals().add( principal );
        return true;
    }
    ...
}
```

Hazelcast has an abstract implementation of `LoginModule` that does callback and cleanup operations and holds the resulting `Credentials` instance. `LoginModule`'s extending `ClusterLoginModule` can access `Credentials`, `Subject`, `LoginModule` instances and options and `sharedState` maps. Extending the `ClusterLoginModule` is recommended instead of implementing all required stuff.

```
public abstract class ClusterLoginModule implements LoginModule {
    protected abstract boolean onLogin() throws LoginException;
    protected abstract boolean onCommit() throws LoginException;
    protected abstract boolean onAbort() throws LoginException;
    protected abstract boolean onLogout() throws LoginException;
}
```

### 19.9.1. Enterprise Integration

Using the above API, you can implement a `LoginModule` that performs authentication against the Security System of your choice, such as an LDAP store like [Apache Directory](#) or some other corporate standard you might have. For example, you may wish to have your clients send an identification token in the `Credentials` object. This token can then be sent to your back-end security system via the `LoginModule` that runs on the cluster side.

Additionally, the same system may authenticate the user and also then return the roles that are attributed to the user. These roles can then be used for data structure authorization.



Please refer to [JAAS Reference Guide](#) for further information.

## 19.10. Cluster Member Security

### Hazelcast IMDG Enterprise Feature

Hazelcast supports standard Java Security (JAAS) based authentication between cluster members. To implement it, you configure one or more `LoginModules` and an instance of `com.hazelcast.security.ICredentialsFactory`. Although Hazelcast has default implementations using cluster groups and `UsernamePasswordCredentials` on authentication, it is recommended that you implement the `LoginModules` and an instance of `com.hazelcast.security.ICredentialsFactory` according to your specific needs and environment.

```

<security enabled="true">
  <member-credentials-factory
    class-name="com.hazelcast.examples.MyCredentialsFactory">
    <properties>
      <property name="property1">value1</property>
      <property name="property2">value2</property>
    </properties>
  </member-credentials-factory>
  <member-login-modules>
    <login-module usage="REQUIRED"
      class-name="com.hazelcast.examples.MyRequiredLoginModule">
      <properties>
        <property name="property3">value3</property>
      </properties>
    </login-module>
    <login-module usage="SUFFICIENT"
      class-name="com.hazelcast.examples.MySufficientLoginModule">
      <properties>
        <property name="property4">value4</property>
      </properties>
    </login-module>
    <login-module usage="OPTIONAL"
      class-name="com.hazelcast.examples.MyOptionalLoginModule">
      <properties>
        <property name="property5">value5</property>
      </properties>
    </login-module>
  </member-login-modules>
  ...
</security>

```

You can define as many as LoginModules as you want in configuration. They are executed in the order listed in configuration. The `usage` attribute has 4 values: 'required', 'requisite', 'sufficient' and 'optional' as defined in `javax.security.auth.login.AppConfigurationEntry.LoginModuleControlFlag`.

```

package com.hazelcast.security;
/**
 * ICredentialsFactory is used to create Credentials objects to be used
 * during member authentication before connection accepted by master member.
 */
public interface ICredentialsFactory {

    void configure( GroupConfig groupConfig, Properties properties );

    Credentials newCredentials();

    void destroy();
}

```

Properties defined in the configuration are passed to the `ICredentialsFactory.configure()` method as `java.util.Properties` and to the `LoginModule.initialize()` method as `java.util.Map`.

## 19.11. Native Client Security

### Hazelcast IMDG Enterprise Feature

Hazelcast's Client security includes both authentication and authorization.

#### 19.11.1. Authentication

The authentication mechanism works the same as cluster member authentication. To implement client authentication, you configure a `Credential` and one or more `LoginModules`. The client side also needs a factory object as in member side, e.g., the `ICredentialsFactory` given in the [Cluster Member Security](#) section above.

```
<security enabled="true">
  <client-login-modules>
    <login-module usage="REQUIRED"
      class-name="com.hazelcast.examples.MyRequiredClientLoginModule">
      <properties>
        <property name="property3">value3</property>
      </properties>
    </login-module>
    <login-module usage="SUFFICIENT"
      class-name="com.hazelcast.examples.MySufficientClientLoginModule">
      <properties>
        <property name="property4">value4</property>
      </properties>
    </login-module>
    <login-module usage="OPTIONAL"
      class-name="com.hazelcast.examples.MyOptionalClientLoginModule">
      <properties>
        <property name="property5">value5</property>
      </properties>
    </login-module>
  </client-login-modules>
  ...
</security>
```

You can define as many as `LoginModules` as you want in the configuration. Those are executed in the order given in configuration. The `usage` attribute has 4 values: 'required', 'requisite', 'sufficient' and 'optional' as defined in `javax.security.auth.login.AppConfigurationEntry.LoginModuleControlFlag`.

```
ClientConfig clientConfig = new ClientConfig();
clientConfig.setCredentials( new UsernamePasswordCredentials( "dev", "dev-pass" ) );
HazelcastInstance client = HazelcastClient.newHazelcastClient( clientConfig );
```



See an implementation and configuration example [here](#).

## 19.11.2. Authorization

Hazelcast client authorization is configured by a client permission policy. Hazelcast has a default permission policy implementation that uses permission configurations defined in the Hazelcast security configuration. Default policy permission checks are done against instance types (map, queue, etc.), instance names (map, queue, name, etc.), instance actions (put, read, remove, add, etc.), client endpoint addresses and client principal defined by the Credentials object. The default permission policy allows to use comma separated names in the principal attribute configuration. Instance and principal names and endpoint addresses can be defined as wildcards(\*). Please see the [Network Configuration section](#) and [Using Wildcards section](#).

```
<security enabled="true">
  <client-permissions>
    <!-- Principals 'admin' and 'root' from endpoint '127.0.0.1' have all permissions. -->
    -->
    <all-permissions principal="admin,root">
      <endpoints>
        <endpoint>127.0.0.1</endpoint>
      </endpoints>
    </all-permissions>

    <!-- Principals named 'dev' from all endpoints have 'create', 'destroy',
      'put', 'read' permissions for map named 'myMap'. -->
    <map-permission name="myMap" principal="dev">
      <actions>
        <action>create</action>
        <action>destroy</action>
        <action>put</action>
        <action>read</action>
      </actions>
    </map-permission>

    <!-- All principals from endpoints '127.0.0.1' or matching to '10.10.*.*'
      have 'put', 'read', 'remove' permissions for map
      whose name matches to 'com.foo.entity.*'. -->
    <map-permission name="com.foo.entity.*">
      <endpoints>
        <endpoint>10.10.*.*</endpoint>
        <endpoint>127.0.0.1</endpoint>
      </endpoints>
      <actions>
        <action>put</action>
        <action>read</action>
        <action>remove</action>
      </actions>
    </map-permission>
  </client-permissions>
</security>
```

```

<!-- Principals named 'dev' from endpoints matching to either
      '192.168.1.1-100' or '192.168.2.*'
      have 'create', 'add', 'remove' permissions for all queues. -->
<queue-permission name="*" principal="dev">
  <endpoints>
    <endpoint>192.168.1.1-100</endpoint>
    <endpoint>192.168.2.*</endpoint>
  </endpoints>
  <actions>
    <action>create</action>
    <action>add</action>
    <action>remove</action>
  </actions>
</queue-permission>

<!-- All principals from all endpoints have transaction permission.-->
<transaction-permission />
</client-permissions>
</security>

```

You can also define your own policy by implementing `com.hazelcast.security.IPermissionPolicy`.

```

package com.hazelcast.security;
/**
 * IPermissionPolicy is used to determine any Subject's
 * permissions to perform a security sensitive Hazelcast operation.
 *
 */
public interface IPermissionPolicy {
    void configure( SecurityConfig securityConfig, Properties properties );

    PermissionCollection getPermissions( Subject subject,
                                        Class<? extends Permission> type );

    void destroy();
}

```

Permission policy implementations can access the client permissions that are in the configuration by using the `SecurityConfig.getClientPermissionConfigs()` method when Hazelcast calls `configure(SecurityConfig securityConfig, Properties properties)`.

The `IPermissionPolicy.getPermissions(Subject subject, Class<? extends Permission> type)` method is used to determine a client request that has been granted permission to perform a security-sensitive operation.

Permission policy should return a `PermissionCollection` containing permissions of the given type for the given `Subject`. The Hazelcast access controller will call `PermissionCollection.implies(Permission)` on returning `PermissionCollection` and it will decide whether or not the current `Subject` has permission to access the requested resources.

### 19.11.3. Permissions

The following is the list of client permissions that can be configured on the member:

- All Permission

```
<all-permissions principal="principal">
  <endpoints>
    ...
  </endpoints>
</all-permissions>
```

- Map Permission

```
<map-permission name="name" principal="principal">
  <endpoints>
    ...
  </endpoints>
  <actions>
    ...
  </actions>
</map-permission>
```

Actions: all, create, destroy, put, read, remove, lock, intercept, index, listen

- Queue Permission

```
<queue-permission name="name" principal="principal">
  <endpoints>
    ...
  </endpoints>
  <actions>
    ...
  </actions>
</queue-permission>
```

Actions: all, create, destroy, add, remove, read, listen

- Multimap Permission



```
<multimap-permission name="name" principal="principal">
  <endpoints>
    ...
  </endpoints>
  <actions>
    ...
  </actions>
</multimap-permission>
```

Actions: all, create, destroy, put, read, remove, listen, lock

- Topic Permission

```
<topic-permission name="name" principal="principal">
  <endpoints>
    ...
  </endpoints>
  <actions>
    ...
  </actions>
</topic-permission>
```

Actions: create, destroy, publish, listen

- List Permission

```
<list-permission name="name" principal="principal">
  <endpoints>
    ...
  </endpoints>
  <actions>
    ...
  </actions>
</list-permission>
```

Actions: all, create, destroy, add, read, remove, listen

- Set Permission

```
<set-permission name="name" principal="principal">
  <endpoints>
    ...
  </endpoints>
  <actions>
    ...
  </actions>
</set-permission>
```

Actions: all, create, destroy, add, read, remove, listen

- Lock Permission

```
<lock-permission name="name" principal="principal">
  <endpoints>
    ...
  </endpoints>
  <actions>
    ...
  </actions>
</lock-permission>
```

Actions: all, create, destroy, lock, read

- AtomicLong Permission

```
<atomic-long-permission name="name" principal="principal">
  <endpoints>
    ...
  </endpoints>
  <actions>
    ...
  </actions>
</atomic-long-permission>
```

Actions: all, create, destroy, read, modify

- CountdownLatch Permission

```
<countdown-latch-permission name="name" principal="principal">
  <endpoints>
    ...
  </endpoints>
  <actions>
    ...
  </actions>
</countdown-latch-permission>
```

Actions: all, create, destroy, modify, read

- IdGenerator Permission

```
<id-generator-permission name="name" principal="principal">
  <endpoints>
    ...
  </endpoints>
  <actions>
    ...
  </actions>
</id-generator-permission>
```

Actions: all, create, destroy, modify, read

- FlakeIdGenerator Permission

```
<flake-id-generator-permission name="name" principal="principal">
  <endpoints>
    ...
  </endpoints>
  <actions>
    ...
  </actions>
</flake-id-generator-permission>
```

Actions: all, create, destroy, modify

- Semaphore Permission

```
<semaphore-permission name="name" principal="principal">
  <endpoints>
    ...
  </endpoints>
  <actions>
    ...
  </actions>
</semaphore-permission>
```

Actions: all, create, destroy, acquire, release, read

- Executor Service Permission

```
<executor-service-permission name="name" principal="principal">
  <endpoints>
    ...
  </endpoints>
  <actions>
    ...
  </actions>
</executor-service-permission>
```

Actions: all, create, destroy

- Transaction Permission

```
<transaction-permission principal="principal">
  <endpoints>
    ...
  </endpoints>
</transaction-permission>
```

- Cache Permission

```
<cache-permission name="/hz/cache-name" principal="principal">
  <endpoints>
    ...
  </endpoints>
  <actions>
    ...
  </actions>
</cache-permission>
```

Actions: all, create, destroy, put, read, remove, listen

- User Code Deployment Permission

```
<user-code-deployment-permission principal="principal">
  <endpoints>
    ...
  </endpoints>
  <actions>
    ...
  </actions>
</user-code-deployment-permission>
```

Actions: all, deploy



The name provided in `cache-permission` must be the Hazelcast distributed object name corresponding to the `Cache` as described in [JCache - Hazelcast Instance Integration](#).

### Handling Permissions When a New Member Joins

By default, the set of permissions defined in the leader member of a cluster is distributed to the newly joining members, overriding their own permission configurations, if any. However, you can configure a new member to be joined, so that it keeps its own set of permissions and even send these to the existing members in the cluster. This can be done dynamically, i.e., without needing to restart the cluster, using the `hazelcast.security.permissions.operation.on-join` system property. Using this property, you can choose whether a new member joining to a cluster will apply the client permissions stored in its own configuration, or use the ones defined in the cluster.

You can set the `hazelcast.security.permissions.operation.on-join` system property to the following values:

- **RECEIVE**: Applies the permissions from the leader member in the cluster before join. This is the default value.
- **SEND**: Doesn't apply the permissions from the leader member before join. If the security is enabled, then it refreshes or replaces the cluster wide permissions with the ones in the new member after the join is complete. This option is suitable for the scenarios where you need to replace the cluster wide permissions without restarting the cluster.
- **NONE**: Neither applies pre-join permissions, nor sends the local permissions to other members. It means that the new member does not send its own permission definitions to the cluster, but keeps them when it joins. However, after the join, when you update the permissions in the other cluster members, those updates are also sent to the newly joining member. Therefore, this option is suitable for the scenarios where you need to elevate privileges temporarily on a single member (preferably a [lite member](#)) for a limited time period. The clients which want to use these temporary permissions have to access the cluster through this single new member, meaning that you need to disable [smart routing](#) for such clients.

Note that, the `create` and `destroy` permissions will not work when using the **NONE** option, since the distributed objects need to be created/destroyed on all the members.

# 20. Performance

This chapter provides information on the performance features of Hazelcast including near cache, slow operations detector, back pressure and data affinity. Moreover, the chapter describes the best performance practices for Hazelcast deployed on Amazon EC2. It also describes the threading models for I/O, events, executors and operations.

## 20.1. Data Affinity

Data affinity ensures that related entries exist on the same member. If related data is on the same member, operations can be executed without the cost of extra network calls and extra wire data. This feature is provided by using the same partition keys for related data.

### 20.1.1. PartitionAware

#### Co-location of related data and computation

Hazelcast has a standard way of finding out which member owns/manages each key object. The following operations will be routed to the same member, since all of them are operating based on the same key "key1".

```
HazelcastInstance hazelcastInstance = Hazelcast.newHazelcastInstance();
Map mapA = hazelcastInstance.getMap( "mapA" );
Map mapB = hazelcastInstance.getMap( "mapB" );
Map mapC = hazelcastInstance.getMap( "mapC" );

// since map names are different, operation will be manipulating
// different entries, but the operation will take place on the
// same member since the keys ("key1") are the same
mapA.put( "key1", value );
mapB.get( "key1" );
mapC.remove( "key1" );

// lock operation will still execute on the same member
// of the cluster since the key ("key1") is same
hazelcastInstance.getLock( "key1" ).lock();

// distributed execution will execute the 'runnable' on the
// same member since "key1" is passed as the key.
hazelcastInstance.getExecutorService().executeOnKeyOwner( runnable, "key1" );
```

When the keys are the same, entries are stored on the same member. But we sometimes want to have related entries stored on the same member, such as a customer and his/her order entries. We would have a customers map with customerId as the key and an orders map with orderId as the key. Since customerId and orderId are different keys, a customer and his/her orders may fall into different members in your cluster. So how can we have them stored on the same member? We create an affinity between customer and orders. If we make them part of the same partition then

these entries will be co-located. We achieve this by making `OrderKey` s `PartitionAware`.

```
final class OrderKey implements PartitionAware, Serializable {

    private final long orderId;
    private final long customerId;

    OrderKey(long orderId, long customerId) {
        this.orderId = orderId;
        this.customerId = customerId;
    }

    long getOrderId() {
        return orderId;
    }

    @Override
    public Object getPartitionKey() {
        return customerId;
    }

    @Override
    public String toString() {
        return "OrderKey{"
            + "orderId=" + orderId
            + ", customerId=" + customerId
            + '}';
    }
}
```

Notice that `OrderKey` implements `PartitionAware` and that `getPartitionKey()` returns the `customerId`. This will make sure that the `Customer` entry and its `Order` s will be stored on the same member.

```
HazelcastInstance hazelcastInstance = Hazelcast.newHazelcastInstance();
Map mapCustomers = hazelcastInstance.getMap( "customers" );
Map mapOrders = hazelcastInstance.getMap( "orders" );

// create the customer entry with customer id = 1
mapCustomers.put( 1, customer );

// now create the orders for this customer
mapOrders.put( new OrderKey( 21, 1 ), order );
mapOrders.put( new OrderKey( 22, 1 ), order );
mapOrders.put( new OrderKey( 23, 1 ), order );
```

Assume that you have a customers map where `customerId` is the key and the customer object is the value. You want to remove one of the customer orders and return the number of remaining orders. Here is how you would normally do it.

```

public static int removeOrder( long customerId, long orderId ) throws Exception {
    IMap<Long, Customer> mapCustomers = instance.getMap( "customers" );
    IMap mapOrders = hazelcastInstance.getMap( "orders" );

    mapCustomers.lock( customerId );
    mapOrders.remove( orderId );
    Set orders = orderMap.keySet(Predicates.equal( "customerId", customerId ));
    mapCustomers.unlock( customerId );

    return orders.size();
}

```

There are couple of things you should consider.

- There are four distributed operations there: lock, remove, keySet, unlock. Can you reduce the number of distributed operations?
- The customer object may not be that big, but can you not have to pass that object through the wire? Think about a scenario where you set order count to the customer object for fast access, so you should do a get and a put, and as a result, the customer object is passed through the wire twice.

Instead, why not move the computation over to the member (JVM) where your customer data resides. Here is how you can do this with distributed executor service.

1. Send a **PartitionAware Callable** task.
2. **Callable** does the deletion of the order right there and returns with the remaining order count.
3. Upon completion of the **Callable** task, return the result (remaining order count). You do not have to wait until the task is completed; since distributed executions are asynchronous, you can do other things in the meantime.

Here is an example code.

```

HazelcastInstance hazelcastInstance = Hazelcast.newHazelcastInstance();

public int removeOrder(long customerId, long orderId) throws Exception {
    IExecutorService executorService = hazelcastInstance.getExecutorService(
"ExecutorService");

    OrderDeletionTask task = new OrderDeletionTask(customerId, orderId);
    Future<Integer> future = executorService.submit(task);
    int remainingOrders = future.get();

    return remainingOrders;
}

public static class OrderDeletionTask
    implements Callable<Integer>, PartitionAware, Serializable,
HazelcastInstanceAware {

```



```

private long orderId;
private long customerId;
private HazelcastInstance hazelcastInstance;

public OrderDeletionTask() {
}

public OrderDeletionTask(long customerId, long orderId) {
    this.customerId = customerId;
    this.orderId = orderId;
}

@Override
public Integer call() {
    IMap<Long, Customer> customerMap = hazelcastInstance.getMap("customers");
    IMap<OrderKey, Order> orderMap = hazelcastInstance.getMap("orders");

    customerMap.lock(customerId);

    Predicate predicate = Predicates.equal("customerId", customerId);
    Set<OrderKey> orderKeys = orderMap.localKeySet(predicate);
    int orderCount = orderKeys.size();
    for (OrderKey key : orderKeys) {
        if (key.orderId == orderId) {
            orderCount--;
            orderMap.delete(key);
        }
    }

    customerMap.unlock(customerId);

    return orderCount;
}

@Override
public Object getPartitionKey() {
    return customerId;
}

@Override
public void setHazelcastInstance(HazelcastInstance hazelcastInstance) {
    this.hazelcastInstance = hazelcastInstance;
}
}

```

The benefits of doing the same operation with distributed `ExecutorService` based on the key are:

- Only one distributed execution (`executorService.submit(task)`), instead of four.
- Less data is sent over the wire.

- Since lock/update/unlock cycle is done locally (local to the customer data), lock duration for the `Customer` entry is much less, thus enabling higher concurrency.

### 20.1.2. PartitioningStrategy

Another way of storing the related data on the same location is using/implementing the class `PartitioningStrategy`. Normally (if no partitioning strategy is defined), Hazelcast finds the partition of a key first by converting the object to binary and then by hashing this binary. If a partitioning strategy is defined, Hazelcast injects the key to the strategy and the strategy returns an object out of which the partition is calculated by hashing it.

Hazelcast offers the following out-of-the-box partitioning strategies:

- `DefaultPartitioningStrategy`: Default strategy. It checks whether the key implements `PartitionAware`. If it implements, the object is converted to binary and then hashed, to find the partition of the key.
- `StringPartitioningStrategy`: Works only for string keys. It uses the string after `@` character as the partition ID. For example, if you have two keys `ordergroup1@region1` and `customergroup1@region1`, both `ordergroup1` and `customergroup1` will fall into the partition where `region1` is located.
- `StringAndPartitionAwarePartitioningStrategy`: Works as the combination of the above two strategies. If the key implements `PartitionAware`, it works like the `DefaultPartitioningStrategy`. If it is a string key, it works like the `StringPartitioningStrategy`.

Following are the example configuration snippets. Note that these strategy configurations are **per map**.

#### Declarative Configuration

```
<hazelcast>
...
  <map name="name-of-the-map">
    ...
    <partition-strategy>
      com.hazelcast.partition.strategy.StringAndPartitionAwarePartitioningStrategy
    </partition-strategy>
    ...
  </map>
...
</hazelcast>
```

#### Programmatic Configuration

```

Config config = new Config();
MapConfig mapConfig = config.getMapConfig("name-of-the-map");
PartitioningStrategyConfig psConfig = mapConfig.getPartitioningStrategyConfig();
psConfig.setPartitioningStrategyClass( "StringAndPartitionAwarePartitioningStrategy"
);

// OR
psConfig.setPartitioningStrategy(YourCustomPartitioningStrategy);
...

```

You can also define your own partition strategy by implementing the class `PartitioningStrategy`. To enable your implementation, add the full class name to your Hazelcast configuration using either the declarative or programmatic approach, as sampled above.

As stated previously, above strategies are defined **per map** in your Hazelcast member. You can also define a strategy **per member** in your Hazelcast cluster. This can be done by defining the `hazelcast.partitioning.strategy.class` system property. An example declarative way of configuring this property is shown below:

```

<hazelcast>
...
  <properties>
    <property name="hazelcast.partitioning.strategy.class">
      com.hazelcast.partition.strategy.StringAndPartitionAwarePartitioningStrategy
    </property>
    ....
  </properties>
  ...
</hazelcast>

```

You can also use other system property configuring options as explained in the [Configuring with System Properties section](#).

## 20.2. Running in EC2

For the best performance of your Hazelcast in AWS EC2:

- It is best to select the newest Linux AMIs.
- HVM based instances give the best performance.
- Select at least a system with 8 vCPUs, e.g., c4.2xlarge. For an overview of all types of EC2 instances, please check <https://www.ec2instances.info>.
- Consider setting a placement group. A placement group can have a significant impact on the performance.

## 20.3. Back Pressure

Hazelcast uses operations to make remote calls. For example, a `map.get` is an operation and a `map.put` is one operation for the primary and one operation for each of the backups, i.e. `map.put` is executed for the primary and also for each backup. In most cases, there will be a natural balance between the number of threads performing operations and the number of operations being executed. However, there are two situations where this balance and operations can pile up and eventually lead to Out of Memory Exception (OOM):

- Asynchronous calls: With async calls, the system may be flooded with the requests.
- Asynchronous backups: The asynchronous backups may be piling up.

To prevent the system from crashing, Hazelcast provides back pressure. Back pressure works by:

- limiting the number of concurrent operation invocations,
- periodically making an async backup sync.

### 20.3.1. Member Side

Back pressure is disabled by default and you can enable it using the following system property:

```
hazelcast.backpressure.enabled
```

To control the number of concurrent invocations, you can configure the number of invocations allowed per partition using the following system property:

```
hazelcast.backpressure.max.concurrent.invocations.per.partition
```

The default value of this system property is 100. Using a default configuration a system is allowed to have  $(271 + 1) * 100 = 27200$  concurrent invocations (271 partitions + 1 for generic operations).

Back pressure is only applied to normal operations. System operations like heart beats and partition migration operations are not influenced by back pressure. 27200 invocations might seem like a lot, but keep in mind that executing a task on `IExecutor` or acquiring a lock also requires an operation.

If the maximum number of invocations has been reached, Hazelcast will automatically apply an exponential back off policy. This gives the system some time to deal with the load. Using the following system property, you can configure the maximum time to wait before a `HazelcastOverloadException` is thrown:

```
hazelcast.backpressure.backoff.timeout.millis
```

This system property's default value is 60000 milliseconds.

The Health Monitor keeps an eye on the usage of the invocations. If it sees a member has consumed 70% or more of the invocations, it starts to log health messages.

Apart from controlling the number of invocations, you also need to control the number of pending async backups. This is done by periodically making these backups sync instead of async. This forces all pending backups to get drained. For this, Hazelcast tracks the number of asynchronous backups

for each partition. At every **Nth** call, one synchronization is forced. This N is controlled through the following property:

`hazelcast.backpressure.syncwindow`

This system property's default value is 100. It means, out of 100 **asynchronous** backups, Hazelcast makes 1 of them a **synchronous** one. A randomization is added, so the sync window with default configuration will be between 75 and 125 invocations.

### 20.3.2. Client Side

To prevent the system at the client side from overloading, you can apply a constraint on the number of concurrent invocations. You can use the following system property at the client side for this purpose:

`hazelcast.client.max.concurrent.invocations`

This property defines the maximum allowed number of concurrent invocations. When it is not explicitly set, it has the value `Integer.MAX_VALUE` by default, which means infinite. When you set it and if the maximum number of concurrent invocations is exceeded this value, Hazelcast will throw `HazelcastOverloadException` when a new invocation comes in.

Please note that back off timeout and controlling the number of pending async backups (sync window) is not supported at the client side.



Please refer to the [System Properties appendix](#) to learn how to configure the system properties.

## 20.4. Threading Model

Your application server has its own threads. Hazelcast does not use these; it manages its own threads.

### 20.4.1. I/O Threading

Hazelcast uses a pool of threads for I/O. A single thread does not perform all the I/O. Instead, multiple threads perform the I/O. On each cluster member, the I/O threading is split up in 3 types of I/O threads:

- I/O thread for the accept requests.
- I/O threads to read data from other members/clients.
- I/O threads to write data to other members/clients.

You can configure the number of I/O threads using the `hazelcast.io.thread.count` system property. Its default value is 3 per member. If 3 is used, in total there are 7 I/O threads: 1 accept I/O thread, 3 read I/O threads and 3 write I/O threads. Each I/O thread has its own Selector instance and waits on the `Selector.select` if there is nothing to do.



You can also specify counts for input and output threads separately. There are `hazelcast.io.input.thread.count` and `hazelcast.io.output.thread.count` properties for this purpose. Please refer to the [System Properties section](#) for information on these properties and how to set them.

Hazelcast periodically scans utilization of each I/O thread and can decide to migrate a connection to a new thread if the existing thread is servicing a disproportionate number of I/O events. You can customize the scanning interval by configuring the `hazelcast.io.balancer.interval.seconds` system property; its default interval is 20 seconds. You can disable the balancing process by setting this property to a negative value.

In case of the read I/O thread, when sufficient bytes for a packet have been received, the `Packet` object is created. This `Packet` object is then sent to the system where it is de-multiplexed. If the `Packet` header signals that it is an operation/response, the `Packet` is handed over to the operation service (please see the [Operation Threading section](#)). If the `Packet` is an event, it is handed over to the event service (please see the [Event Threading section](#)).

## 20.4.2. Event Threading

Hazelcast uses a shared event system to deal with components that rely on events, such as topic, collections, listeners and Near Cache.

Each cluster member has an array of event threads and each thread has its own work queue. When an event is produced, either locally or remotely, an event thread is selected (depending on if there is a message ordering) and the event is placed in the work queue for that event thread.

The following properties can be set to alter the behavior of the system.

- `hazelcast.event.thread.count`: Number of event-threads in this array. Its default value is 5.
- `hazelcast.event.queue.capacity`: Capacity of the work queue. Its default value is 1000000.
- `hazelcast.event.queue.timeout.millis`: Timeout for placing an item on the work queue in milliseconds. Its default value is 250 milliseconds.

If you process a lot of events and have many cores, changing the value of `hazelcast.event.thread.count` property to a higher value is a good practice. This way, more events can be processed in parallel.

Multiple components share the same event queues. If there are 2 topics, say A and B, for certain messages they may share the same queue(s) and hence the same event thread. If there are a lot of pending messages produced by A, then B needs to wait. Also, when processing a message from A takes a lot of time and the event thread is used for that, B suffers from this. That is why it is better to offload processing to a dedicated thread (pool) so that systems are better isolated.

If the events are produced at a higher rate than they are consumed, the queue grows in size. To prevent overloading the system and running into an `OutOfMemoryException`, the queue is given a capacity of 1 million items. When the maximum capacity is reached, the items are dropped. This means that the event system is a 'best effort' system. There is no guarantee that you are going to get an event. Topic A might have a lot of pending messages and therefore B cannot receive messages

because the queue has no capacity and messages for B are dropped.

### 20.4.3. IExecutor Threading

Executor threading is straight forward. When a task is received to be executed on Executor E, then E will have its own `ThreadPoolExecutor` instance and the work is placed in the work queue of this executor. Thus, Executors are fully isolated, but still share the same underlying hardware - most importantly the CPUs.

You can configure the IExecutor using the `ExecutorConfig` (programmatic configuration) or using `<executor>` (declarative configuration). Please also see the [Configuring Executor Service](#) section.

### 20.4.4. Operation Threading

There are 2 types of operations:

- Operations that are aware of a certain partition, e.g., `IMap.get(key)`.
- Operations that are not partition aware, such as the `IExecutorService.executeOnMember(command, member)` operation.

Each of these operation types has a different threading model explained in the following sections.

#### Partition-aware Operations

To execute partition-aware operations, an array of operation threads is created. The default value of this array's size is the number of cores and it has a minimum value of 2. This value can be changed using the `hazelcast.operation.thread.count` property.

Each operation thread has its own work queue and it consumes messages from this work queue. If a partition-aware operation needs to be scheduled, the right thread is found using the formula below.

```
threadIndex = partitionId % partition thread-count
```

After the `threadIndex` is determined, the operation is put in the work queue of that operation thread. This means the followings:

- A single operation thread executes operations for multiple partitions; if there are 271 partitions and 10 partition threads, then roughly every operation thread executes operations for 27 partitions.
- Each partition belongs to only 1 operation thread. All operations for a partition are always handled by exactly the same operation thread.
- Concurrency control is not needed to deal with partition-aware operations because once a partition-aware operation is put in the work queue of a partition-aware operation thread, only 1 thread is able to touch that partition.

Because of this threading strategy, there are two forms of false sharing you need to be aware of:

- False sharing of the partition - two completely independent data structures share the same

partition. For example, if there is a map `employees` and a map `orders`, the method `employees.get("peter")` running on partition 25 may be blocked by the method `orders.get(1234)` also running on partition 25. If independent data structures share the same partition, a slow operation on one data structure can slow down the other data structures.

- False sharing of the partition-aware operation thread - each operation thread is responsible for executing operations on a number of partitions. For example, **thread 1** could be responsible for partitions 0, 10, 20, etc. and **thread-2** could be responsible for partitions 1, 11, 21, etc. If an operation for partition 1 takes a lot of time, it blocks the execution of an operation for partition 11 because both of them are mapped to the same operation thread.

You need to be careful with long running operations because you could starve operations of a thread. As a general rule, the partition thread should be released as soon as possible because operations are not designed as long running operations. That is why, for example, it is very dangerous to execute a long running operation using `AtomicReference.alter()` or an `IMap.executeOnKey()`, because these operations block other operations to be executed.

Currently, there is no support for work stealing. Different partitions that map to the same thread may need to wait till one of the partitions is finished, even though there are other free partition-aware operation threads available.

### Example:

Take a cluster with three members. Two members will have 90 primary partitions and one member will have 91 primary partitions. Let's say you have one CPU and four cores per CPU. By default, four operation threads will be allocated to serve 90 or 91 partitions.

### Non-Partition-aware Operations

To execute operations that are not partition-aware, e.g., `IExecutorService.executeOnMember(command, member)`, generic operation threads are used. When the Hazelcast instance is started, an array of operation threads is created. The size of this array has a default value of the number of cores divided by two with a minimum value of 2. It can be changed using the `hazelcast.operation.generic.thread.count` property.

A non-partition-aware operation thread does not execute an operation for a specific partition. Only partition-aware operation threads execute partition-aware operations.

Unlike the partition-aware operation threads, all the generic operation threads share the same work queue: `genericWorkQueue`.

If a non-partition-aware operation needs to be executed, it is placed in that work queue and any generic operation thread can execute it. The big advantage is that you automatically have work balancing since any generic operation thread is allowed to pick up work from this queue.

The disadvantage is that this shared queue can be a point of contention. You may not see this contention in production since performance is dominated by I/O and the system does not run many non-partition-aware operations.



## Priority Operations

In some cases, the system needs to run operations with a higher priority, e.g., an important system operation. To support priority operations, Hazelcast has the following features:

- For partition-aware operations: Each partition thread has its own work queue and it also has a priority work queue. The partition thread always checks the priority queue before it processes work from its normal work queue.
- For non-partition-aware operations: Next to the `genericWorkQueue`, there is also a `genericPriorityWorkQueue`. When a priority operation needs to be run, it is put in the `genericPriorityWorkQueue`. Like the partition-aware operation threads, a generic operation thread first checks the `genericPriorityWorkQueue` for work.

Since a worker thread blocks on the normal work queue (either partition specific or generic), a priority operation may not be picked up because it is not put in the queue where it is blocking. Hazelcast always sends a 'kick the worker' operation that only triggers the worker to wake up and check the priority queue.

## Operation-response and Invocation-future

When an Operation is invoked, a `Future` is returned. Please see the example code below.

```
GetOperation operation = new GetOperation( mapName, key );
Future future = operationService.invoke( operation );
future.get();
```

The calling side blocks for a reply. In this case, `GetOperation` is set in the work queue for the partition of `key`, where it eventually is executed. Upon execution, a response is returned and placed on the `genericWorkQueue` where it is executed by a "generic operation thread". This thread signals the `future` and notifies the blocked thread that a response is available. Hazelcast has a plan of exposing this `future` to the outside world, and we will provide the ability to register a completion listener so you can perform asynchronous calls.

## Local Calls

When a local partition-aware call is done, an operation is made and handed over to the work queue of the correct partition operation thread, and a `future` is returned. When the calling thread calls `get` on that `future`, it acquires a lock and waits for the result to become available. When a response is calculated, the `future` is looked up and the waiting thread is notified.

In the future, this will be optimized to reduce the amount of expensive systems calls, such as `lock.acquire()/notify()` and the expensive interaction with the operation-queue. Probably, we will add support for a caller-runs mode, so that an operation is directly run on the calling thread.

## 20.5. SlowOperationDetector

The `SlowOperationDetector` monitors the operation threads and collects information about all slow operations. An `Operation` is a task executed by a generic or partition thread (see [Operation](#)

[Threading](#)). An operation is considered as slow when it takes more computation time than the configured threshold.

The `SlowOperationDetector` stores the fully qualified classname of the operation and its stacktrace as well as operation details, start time and duration of each slow invocation. All collected data is available in the [Management Center](#).

The `SlowOperationDetector` is configured via the following system properties.

- `hazelcast.slow.operation.detector.enabled`
- `hazelcast.slow.operation.detector.log.purge.interval.seconds`
- `hazelcast.slow.operation.detector.log.retention.seconds`
- `hazelcast.slow.operation.detector.stacktrace.logging.enabled`
- `hazelcast.slow.operation.detector.threshold.millis`

Please refer to the [System Properties appendix](#) for explanations of these properties.

### 20.5.1. Logging of Slow Operations

The detected slow operations are logged as warnings in the Hazelcast log files:

```
WARN 2015-05-07 11:05:30,890 SlowOperationDetector: [127.0.0.1]:5701
    Slow operation detected: com.hazelcast.map.impl.operation.PutOperation
    Hint: You can enable the logging of stacktraces with the following config
    property: hazelcast.slow.operation.detector.stacktrace.logging.enabled
WARN 2015-05-07 11:05:30,891 SlowOperationDetector: [127.0.0.1]:5701
    Slow operation detected: com.hazelcast.map.impl.operation.PutOperation
    (2 invocations)
WARN 2015-05-07 11:05:30,892 SlowOperationDetector: [127.0.0.1]:5701
    Slow operation detected: com.hazelcast.map.impl.operation.PutOperation
    (3 invocations)
```

Stacktraces are always reported to the Management Center, but by default they are not printed to keep the log size small. If logging of stacktraces is enabled, the full stacktrace is printed every 100 invocations. All other invocations print a shortened version.

### 20.5.2. Purging of Slow Operation Logs

Since a Hazelcast cluster can run for a very long time, Hazelcast purges the slow operation logs periodically to prevent an OOME. You can configure the purge interval and the retention time for each invocation.

The purging removes each invocation whose retention time is exceeded. When all invocations are purged from a slow operation log, the log is deleted.

## 20.6. Near Cache

Map or Cache entries in Hazelcast are partitioned across the cluster members. Hazelcast clients do

not have local data at all. Suppose you read the key `k` a number of times from a Hazelcast client or `k` is owned by another member in your cluster. Then each `map.get(k)` or `cache.get(k)` will be a remote operation, which creates a lot of network trips. If you have a data structure that is mostly read, then you should consider creating a local Near Cache, so that reads are sped up and less network traffic is created.

These benefits do not come for free, please consider the following trade-offs:

- Members with a Near Cache will have to hold the extra cached data, which increases memory consumption.
- If invalidation is enabled and entries are updated frequently, then invalidations will be costly.
- Near Cache breaks the strong consistency guarantees; you might be reading stale data.

Near Cache is highly recommended for data structures that are mostly read.

In a client/server system you must enable the Near Cache separately on the client, without the need to configure it on the server. Please note that Near Cache configuration is specific to the server or client itself: a data structure on a server may not have Near Cache configured while the same data structure on a client may have Near Cache configured. They also can have different Near Cache configurations.

If you are using Near Cache, you should take into account that your hits to the keys in the Near Cache are not reflected as hits to the original keys on the primary members. This has for example an impact on IMap's maximum idle seconds or time-to-live seconds expiration. Therefore, even though there is a hit on a key in Near Cache, your original key on the primary member may expire.



Near Cache works only when you access data via `map.get(k)` or `cache.get(k)` methods. Data returned using a predicate is not stored in the Near Cache.

### 20.6.1. Hazelcast Data Structures with Near Cache Support

The following matrix shows the Hazelcast data structures with Near Cache support. Please have a look at the next section for a detailed explanation of `cache-local-entries`, `local-update-policy`, `preloader` and `serialize-keys`.

Data structure	Near Cache Support	cache-local-entries	local-update-policy	preloader	serialize-keys
IMap member	yes	yes	no	no	yes
IMap client	yes	no	no	yes	yes
JCache member	no	no	no	no	no
JCache client	yes	no	yes	yes	yes
ReplicatedMap member	no	no	no	no	no
ReplicatedMap client	yes	no	no	no	no

Data structure	Near Cache Support	cache-local-entries	local-update-policy	preloader	serialize-keys
Transactional Map member	limited	no	no	no	no
Transactional Map client	no	no	no	no	no



Even though lite members do not store any data for Hazelcast data structures, you can enable Near Cache on lite members for faster reads.

## 20.6.2. Configuring Near Cache

The following shows the configuration for the Hazelcast Near Cache.



Please keep in mind that, if you want to use near cache on a Hazelcast member, configure it on the member; if you want to use it on a Hazelcast client, configure it on the client.

### Declarative:

```
<near-cache name="myDataStructure">
  <in-memory-format>(OBJECT|BINARY|NATIVE)</in-memory-format>
  <serialize-keys>(true|false)</serialize-keys>
  <invalidate-on-change>(true|false)</invalidate-on-change>
  <time-to-live-seconds>(0..INT_MAX)</time-to-live-seconds>
  <max-idle-seconds>(0..INT_MAX)</max-idle-seconds>
  <eviction eviction-policy="(LRU|LFU|RANDOM|NONE)"
    max-size-policy="(ENTRY_COUNT
      |USED_NATIVE_MEMORY_SIZE|USED_NATIVE_MEMORY_PERCENTAGE
      |FREE_NATIVE_MEMORY_SIZE|FREE_NATIVE_MEMORY_PERCENTAGE"
    size="(0..INT_MAX)"/>
  <cache-local-entries>(false|true)</cache-local-entries>
  <local-update-policy>(INVALIDATE|CACHE_ON_UPDATE)</local-update-policy>
  <preloader enabled="(true|false)"
    directory="nearcache-example"
    store-initial-delay-seconds="(0..INT_MAX)"
    store-interval-seconds="(0..INT_MAX)"/>
</near-cache>
```

The element `<near-cache>` has an optional attribute `name` whose default value is `default`.

### Programmatic:

```

EvictionConfig evictionConfig = new EvictionConfig()
    .setMaximumSizePolicy(MaxSizePolicy.ENTRY_COUNT)
    .setEvictionPolicy(EvictionPolicy.LRU)
    .setSize( 1 );

NearCachePreloaderConfig preloaderConfig = new NearCachePreloaderConfig()
    .setEnabled(true)
    .setDirectory("nearcache-example")
    .setStoreInitialDelaySeconds( 1 )
    .setStoreIntervalSeconds( 2 );

NearCacheConfig nearCacheConfig = new NearCacheConfig()
    .setName("myDataStructure")
    .setInMemoryFormat(InMemoryFormat.BINARY)
    .setSerializeKeys(true)
    .setInvalidateOnChange(false)
    .setTimeToLiveSeconds( 1 )
    .setMaxIdleSeconds( 5 )
    .setEvictionConfig(evictionConfig)
    .setCacheLocalEntries(true)
    .setLocalUpdatePolicy(NearCacheConfig.LocalUpdatePolicy.CACHE_ON_UPDATE)
    .setPreloaderConfig(preloaderConfig);

```

The class `NearCacheConfig` is used for all supported Hazelcast data structures on members and clients.

Following are the descriptions of all configuration elements:

- **in-memory-format**: Specifies in which format data will be stored in your Near Cache. Note that a map's in-memory format can be different from that of its Near Cache. Available values are as follows:
  - **BINARY**: Data will be stored in serialized binary format (default value).
  - **OBJECT**: Data will be stored in deserialized form.
  - **NATIVE**: Data will be stored in the Near Cache that uses Hazelcast's High-Density Memory Store feature. This option is available only in Hazelcast IMDG Enterprise HD. Note that a map and its Near Cache can independently use High-Density Memory Store. For example, while your map does not use High-Density Memory Store, its Near Cache can use it.
- **serialize-keys**: Specifies if the keys of a Near Cache entry should be serialized or not. Serializing the keys has a big impact on the read performance of the Near Cache. It should just be activated when you have mutable keys, which are changed after use for the Near Cache. Its default value is **false**.
- **invalidate-on-change**: Specifies whether the cached entries are evicted when the entries are updated or removed. Its default value is **true**.
- **time-to-live-seconds**: Maximum number of seconds for each entry to stay in the Near Cache. Entries that are older than this period are automatically evicted from the Near Cache. Regardless of the eviction policy used, **time-to-live-seconds** still applies. Any integer between 0

and `Integer.MAX_VALUE`. 0 means infinite. Its default value is 0.

- `max-idle-seconds`: Maximum number of seconds each entry can stay in the Near Cache as untouched (not read). Entries that are not read more than this period are removed from the Near Cache. Any integer between 0 and `Integer.MAX_VALUE`. 0 means `Integer.MAX_VALUE`. Its default value is 0.
- `eviction`: Specifies the eviction behavior when you use High-Density Memory Store for your Near Cache. It has the following attributes:
  - `eviction-policy`: Eviction policy configuration. Available values are as follows:
    - `LRU`: Least Recently Used (default value).
    - `LFU`: Least Frequently Used.
    - `NONE`: No items will be evicted and the property `max-size` will be ignored. You still can combine it with `time-to-live-seconds` and `max-idle-seconds` to evict items from the Near Cache.
    - `RANDOM`: A random item will be evicted.
  - `max-size-policy`: Maximum size policy for eviction of the Near Cache. Available values are as follows:
    - `ENTRY_COUNT`: Maximum size based on the entry count in the Near Cache (default value).
    - `USED_NATIVE_MEMORY_SIZE`: Maximum used native memory size of the specified Near Cache in MB to trigger the eviction. If the used native memory size exceeds this threshold, the eviction is triggered. Available only for `NATIVE` in-memory format. This is supported only by Hazelcast IMDG Enterprise.
    - `USED_NATIVE_MEMORY_PERCENTAGE`: Maximum used native memory percentage of the specified Near Cache to trigger the eviction. If the native memory usage percentage (relative to maximum native memory size) exceeds this threshold, the eviction is triggered. Available only for `NATIVE` in-memory format. This is supported only by Hazelcast IMDG Enterprise.
    - `FREE_NATIVE_MEMORY_SIZE`: Minimum free native memory size of the specified Near Cache in MB to trigger the eviction. If free native memory size goes below this threshold, eviction is triggered. Available only for `NATIVE` in-memory format. This is supported only by Hazelcast IMDG Enterprise.
    - `FREE_NATIVE_MEMORY_PERCENTAGE`: Minimum free native memory percentage of the specified Near Cache to trigger eviction. If free native memory percentage (relative to maximum native memory size) goes below this threshold, eviction is triggered. Available only for `NATIVE` in-memory format. This is supported only by Hazelcast IMDG Enterprise.
  - `size`: Maximum size of the Near Cache used for `max-size-policy`. When this is reached the Near Cache is evicted based on the policy defined. Any integer between 1 and `Integer.MAX_VALUE`. This value has different defaults, depending on the data structure.
    - `IMap`: Its default value is `Integer.MAX_VALUE` for on-heap maps and 10000 for the `NATIVE` in-memory format.
    - `JCache`: Its default value is 10000.
- `cache-local-entries`: Specifies whether the local entries will be cached. It can be useful when in-

memory format for Near Cache is different from that of the map. By default, it is disabled. Is just available on Hazelcast members, not on Hazelcast clients (which have no local entries).

- **local-update-policy**: Specifies the update policy of the local Near Cache. It is available on JCache clients. Available values are as follows:
  - **INVALIDATE**: Removes the Near Cache entry on mutation. After the mutative call to the member completes but before the operation returns to the caller, the Near Cache entry is removed. Until the mutative operation completes, the readers still continue to read the old value. But as soon as the update completes the Near Cache entry is removed. Any threads reading the key after this point will have a Near Cache miss and call through to the member, obtaining the new entry. This setting provides read-your-writes consistency. This is the default setting.
  - **CACHE\_ON\_UPDATE**: Updates the Near Cache entry on mutation. After the mutative call to the member completes but before the put returns to the caller, the Near Cache entry is updated. So a remove will remove it and one of the put methods will update it to the new value. Until the update/remove operation completes, the entry's old value can still be read from the Near Cache. But before the call completes the Near Cache entry is updated. Any threads reading the key after this point will read the new entry. If the mutative operation was a remove, the key will no longer exist in the cache, both the Near Cache and the original copy in the member. The member will initiate an invalidate event to any other Near Caches, however the caller Near Cache is not invalidated as it already has the new value. This setting also provides read-your-writes consistency.
- **preloader**: Specifies if the Near Cache should store and pre-load its keys for a faster re-population after a Hazelcast client restart. Is just available on IMap and JCache clients. It has the following attributes:
  - **enabled**: Specifies whether the preloader for this Near Cache is enabled or not, **true** or **false**.
  - **directory**: Specifies the parent directory for the preloader of this Near Cache. The filenames for the preloader storage will be generated from the Near Cache name. You can additionally specify the parent directory to have multiple clients on the same machine with the same Near Cache names.
  - **store-initial-delay-seconds**: Specifies the delay in seconds until the keys of this Near Cache are stored for the first time. Its default value is **600** seconds.
  - **store-interval-seconds**: Specifies the interval in seconds in which the keys of this Near Cache are stored. Its default value is **600** seconds.

### 20.6.3. Near Cache Configuration Examples

This section shows some configuration examples for different Hazelcast data structures.

#### Near Cache Example for IMap

The following are configuration examples for IMap Near Caches for Hazelcast members and clients.

```

<hazelcast>
  <map name="mostlyReadMap">
    <in-memory-format>BINARY</in-memory-format>
    <near-cache>
      <in-memory-format>OBJECT</in-memory-format>
      <invalidate-on-change>>false</invalidate-on-change>
      <time-to-live-seconds>600</time-to-live-seconds>
      <eviction eviction-policy="NONE" max-size-policy="ENTRY_COUNT" size="5000"/>
      <cache-local-entries>>true</cache-local-entries>
    </near-cache>
  </map>
</hazelcast>

```

```

EvictionConfig evictionConfig = new EvictionConfig()
    .setEvictionPolicy(EvictionPolicy.NONE)
    .setMaximumSizePolicy(MaxSizePolicy.ENTRY_COUNT)
    .setSize(5000);

NearCacheConfig nearCacheConfig = new NearCacheConfig()
    .setInMemoryFormat(InMemoryFormat.OBJECT)
    .setInvalidateOnChange(false)
    .setTimeToLiveSeconds(600)
    .setEvictionConfig(evictionConfig);

Config config = new Config();
config.getMapConfig("mostlyReadMap")
    .setInMemoryFormat(InMemoryFormat.BINARY)
    .setNearCacheConfig(nearCacheConfig);

```

The Near Cache configuration for maps on members is a child of the map configuration, so you do not have to define the map name in the Near Cache configuration.

```

<hazelcast-client>
  <near-cache name="mostlyReadMap">
    <in-memory-format>OBJECT</in-memory-format>
    <invalidate-on-change>true</invalidate-on-change>
    <eviction eviction-policy="LRU" max-size-policy="ENTRY_COUNT" size="50000"/>
  </near-cache>
</hazelcast-client>

```



```

EvictionConfig evictionConfig = new EvictionConfig()
    .setEvictionPolicy(EvictionPolicy.LRU)
    .setMaximumSizePolicy(MaxSizePolicy.ENTRY_COUNT)
    .setSize(50000);

NearCacheConfig nearCacheConfig = new NearCacheConfig()
    .setName("mostlyReadMap")
    .setInMemoryFormat(InMemoryFormat.OBJECT)
    .setInvalidateOnChange(true)
    .setEvictionConfig(evictionConfig);

ClientConfig clientConfig = new ClientConfig()
    .addNearCacheConfig(nearCacheConfig);

```

The Near Cache on the client side must have the same name as the data structure on the member for which this Near Cache is being created. You can use wildcards, so in this example `mostlyRead*` would also match the map `mostlyReadMap`.

A Near Cache can have its own `in-memory-format` which is independent of the `in-memory-format` of the data structure.

### Near Cache Example for JCache Clients

The following is a configuration example for a JCache Near Cache for a Hazelcast client.

```

<hazelcast-client>
  <near-cache name="mostlyReadCache">
    <in-memory-format>OBJECT</in-memory-format>
    <invalidate-on-change>true</invalidate-on-change>
    <eviction eviction-policy="LRU" max-size-policy="ENTRY_COUNT" size="30000"/>
    <local-update-policy>CACHE_ON_UPDATE</local-update-policy>
  </near-cache>
</hazelcast-client>

```

```

EvictionConfig evictionConfig = new EvictionConfig()
    .setEvictionPolicy(EvictionPolicy.LRU)
    .setMaximumSizePolicy(MaxSizePolicy.ENTRY_COUNT)
    .setSize(30000);

NearCacheConfig nearCacheConfig = new NearCacheConfig()
    .setName("mostlyReadCache")
    .setInMemoryFormat(InMemoryFormat.OBJECT)
    .setInvalidateOnChange(true)
    .setEvictionConfig(evictionConfig)
    .setLocalUpdatePolicy(LocalUpdatePolicy.CACHE_ON_UPDATE);

ClientConfig clientConfig = new ClientConfig()
    .addNearCacheConfig(nearCacheConfig);

```

## Example for Near Cache with High-Density Memory Store

### Hazelcast IMDG Enterprise HD Feature

The following is a configuration example for an IMap High-Density Near Cache for a Hazelcast member.

```

<hazelcast>
  <map name="mostlyReadMapWithHighDensityNearCache">
    <in-memory-format>OBJECT</in-memory-format>
    <near-cache>
      <in-memory-format>NATIVE</in-memory-format>
      <eviction eviction-policy="LFU" max-size-policy="USED_NATIVE_MEMORY_PERCENTAGE"
size="90"/>
    </near-cache>
  </map>
</hazelcast>

```

```

EvictionConfig evictionConfig = new EvictionConfig()
    .setEvictionPolicy(EvictionPolicy.LFU)
    .setMaximumSizePolicy(MaxSizePolicy.USED_NATIVE_MEMORY_PERCENTAGE)
    .setSize(90);

NearCacheConfig nearCacheConfig = new NearCacheConfig()
    .setInMemoryFormat(InMemoryFormat.NATIVE)
    .setEvictionConfig(evictionConfig);

Config config = new Config();
config.getMapConfig("mostlyReadMapWithHighDensityNearCache")
    .setInMemoryFormat(InMemoryFormat.OBJECT)
    .setNearCacheConfig(nearCacheConfig);

```

Keep in mind that you should have already enabled the High-Density Memory Store usage for your cluster. Please see the [Configuring High-Density Memory Store section](#).

Note that a map and its Near Cache can independently use High-Density Memory Store. For example, if your map does not use High-Density Memory Store, its Near Cache can still use it.

#### 20.6.4. Near Cache Eviction

In the scope of Near Cache, eviction means evicting (clearing) the entries selected according to the given `eviction-policy` when the specified `max-size-policy` has been reached.

The `max-size-policy` defines the state when the Near Cache is full and determines whether the eviction should be triggered. The `size` is either interpreted as entry count, memory size or percentage, depending on the chosen policy.

Once the eviction is triggered the configured `eviction-policy` determines which, if any, entries must be evicted.

#### 20.6.5. Near Cache Expiration

Expiration means the eviction of expired records. A record is expired:

- if it is not touched (accessed/read) for `max-idle-seconds`
- `time-to-live-seconds` passed since it is put to Near Cache

The actual expiration is performed in two cases:

- When a record is accessed: it is checked if the record is expired or not. If it is expired, it is evicted and `null` is returned as the value to the caller.
- In the background: there is an expiration task that periodically (currently 5 seconds) scans records and evicts the expired records.

#### 20.6.6. Near Cache Invalidation

Invalidation is the process of removing an entry from the Near Cache when its value is updated or it is removed from the original data structure (to prevent stale reads). Near Cache invalidation happens asynchronously at the cluster level, but synchronously at the current member. This means that the Near Cache is invalidated within the whole cluster after the modifying operation is finished, but updated from the current member before the modifying operation is done. A modifying operation can be an `EntryProcessor`, an explicit update or remove as well as an expiration or eviction. Generally, whenever the state of an entry changes in the record store by updating its value or removing it, the invalidation event is sent for that entry.

Invalidations can be sent from members to client Near Caches or to member Near Caches, either individually or in batches. Default behavior is sending in batches. If there are lots of mutating operations such as `put/remove` on data structures, it is advised that you configure batch invalidations. This reduces the network traffic and keeps the eventing system less busy, but may increase the delay of individual invalidations.

You can use the following system properties to configure the Near Cache invalidation:

- `hazelcast.map.invalidation.batch.enabled`: Enable or disable batching. Its default value is `true`. When it is set to `false`, all invalidations are sent immediately.
- `hazelcast.map.invalidation.batch.size`: Maximum number of invalidations in a batch. Its default value is `100`.
- `hazelcast.map.invalidation.batchfrequency.seconds`: If the collected invalidations do not reach the configured batch size, a background process sends them periodically. Its default value is `10` seconds.

If there are a lot of clients or many mutating operations, batching should remain enabled and the batch size should be configured with the `hazelcast.map.invalidation.batch.size` system property to a suitable value.

## 20.6.7. Near Cache Consistency

### Eventual Consistency

Near Caches are invalidated by invalidation events. Invalidation events can be lost due to the fire-and-forget fashion of eventing system. If an event is lost, reads from Near Cache can indefinitely be stale.

To solve this problem, starting with Hazelcast 3.8, Hazelcast provides eventually consistent behavior for IMap/JCache Near Caches by detecting invalidation losses. After detection of an invalidation loss, stale data will be made unreachable and Near Cache's `get` calls to that data will be directed to underlying IMap/JCache to fetch the fresh data.

You can configure eventual consistency with the system properties below (same properties are valid for both member and client side Near Caches):

- `hazelcast.invalidation.max.tolerated.miss.count`: Default value is `10`. If missed invalidation count is bigger than this value, relevant cached data will be made unreachable.
- `hazelcast.invalidation.reconciliation.interval.seconds`: Default value is `60` seconds. This is a periodic task that scans cluster members periodically to compare generated invalidation events with the received ones from Near Cache.

### Locally Initiated Changes

For local invalidations, when a record is updated/removed, future reads will see this update/remove to provide read-your-writes consistency. To achieve this consistency, Near Cache configuration provides two update policies:

- `INVALIDATE`
- `CACHE_ON_UPDATE`

If you choose `INVALIDATE`, the entry is removed from the Near Cache after the update/remove occurs in the underlying data structure and before the operation (`get`) returns to the caller. Until the update/remove operation completes, the entry's old value can still be read from the Near Cache.

If you choose `CACHE_ON_UPDATE`, the entry is updated after the update/remove occurs in the underlying data structure and before the operation (put/get) returns to the caller. If it is an update operation, it will remove the entry and the new value will be placed. Until the update/remove operation completes, the entry's old value can still be read from the Near Cache. Any threads reading the key after this point will read the new entry. If the mutative operation was a remove, the key will no longer exist in the Near Cache and the original copy in the member.

### 20.6.8. Near Cache Preloader

The Near Cache preloader is a functionality to store the keys from a Near Cache to provide a fast re-population of the previous hot data set after a Hazelcast Client has been restarted. It is available on IMap and JCache clients.

The Near Cache preloader stores the keys (not the values) of Near Cache entries in regular intervals. You can define the initial delay via `store-initial-delay-seconds`, e.g., if you know that your hot data set will need some time to build up. You can configure the interval via `store-interval-seconds` which determines how often the key-set will be stored. The persistence will not run continuously. Whenever the storage is scheduled, it will be performed on the actual keys in the Near Cache.

The Near Cache preloader will be triggered on the first initialization of the data structure on the client, e.g., `client.getMap("myNearCacheMap")`. This schedules the preloader, which will work in the background, so your application is not blocked. The storage will be enabled after the loading is completed.

The configuration parameter `directory` is optional. If you omit it the base folder will be the user working directory (normally where the JVM was started or configured with the system property `user.dir`). The storage filenames will always be created from the Near Cache name. So even if you use a wildcard name in the Near Cache Configuration, the preloader filenames will be unique.



If you run multiple Hazelcast clients with enabled Near Cache preloader on the same machine, you have to configure a unique storage filename for each client or run them from different user directories. If two clients would write into the same file, only the first client will succeed. The following clients will throw an exception as soon as the Near Cache preloader is triggered.

## 20.7. Caching Deserialized Values

There may be cases where you do not want to deserialize some values in your Hazelcast map again which were already deserialized previously. This way your query operations get faster. This is possible by using the `cache-deserialized-values` element in your declarative Hazelcast configuration, as shown below.

```

<hazelcast>
  ...
  ...
  <map name="myMap">
    ...
    <in-memory-format>BINARY</in-memory-format>
    <cache-deserialized-values>INDEX-ONLY</cache-deserialized-values>
    <backup-count>1</backup-count>
    ...
  </map>
  ...
  ...
</hazelcast>

```

The element `cache-deserialized-values` controls the caching of deserialized values. Note that caching makes the query evaluation faster, but it will consume more memory. This element has the following values:

- NEVER: Deserialized values will never be cached.
- INDEX-ONLY: Deserialized values will be cached only when they are inserted into an index.
- ALWAYS: Deserialized values will always be cached.

If you are using portable serialization or your map's in-memory format is `OBJECT` or `NATIVE`, then `cache-deserialized-values` element does not have any effect.

## 21. Hazelcast Simulator

Hazelcast Simulator is a production simulator used to test Hazelcast and Hazelcast-based applications in clustered environments. It also allows you to create your own tests and perform them on your Hazelcast clusters and applications that are deployed to cloud computing environments. In your tests, you can provide any property that can be specified on these environments (Amazon EC2, Google Compute Engine(GCE), or your own environment): properties such as hardware specifications, operating system, Java version, etc.

Please refer to the documentation on its own GitHub repository at [Hazelcast Simulator](#).

## 22. WAN

### Hazelcast IMDG Enterprise Feature

### 22.1. WAN Replication

There could be cases where you need to synchronize multiple Hazelcast clusters to the same state. Hazelcast WAN Replication allows you to keep multiple Hazelcast clusters in sync by replicating their state over WAN environments such as the Internet.

Imagine you have different data centers in New York, London and Tokyo each running an independent Hazelcast cluster. Every cluster would be operating at native speed in their own LAN (Local Area Network), but you also want some or all record sets in these clusters to be replicated to each other: updates in the Tokyo cluster should also replicate to London and New York and updates in the New York cluster are to be synchronized to the Tokyo and London clusters.

This chapter explains how you can replicate the state of your clusters over Wide Area Network (WAN) through Hazelcast WAN Replication.



You can download the white paper **Hazelcast on AWS: Best Practices for Deployment** at [Hazelcast.com](https:// Hazelcast.com).

### 22.1.1. Defining WAN Replication

Hazelcast supports two different operation modes of WAN Replication:

- **Active-Passive:** This mode is mostly used for failover scenarios where you want to replicate an active cluster to one or more passive clusters, for the purpose of maintaining a backup.
- **Active-Active:** Every cluster is equal, each cluster replicates to all other clusters. This is normally used to connect different clients to different clusters for the sake of the shortest path between client and server.

There are two different ways of defining the WAN replication endpoints:

- Static endpoints
- Discovery SPI

You can use at most one of these when defining a single WAN publisher.

#### Defining WAN Replication Using Static Endpoints

Below is an example of declarative configuration of WAN Replication from New York cluster to target the London cluster:

```

<hazelcast>
...
  <wan-replication name="my-wan-cluster-batch">
    <wan-publisher group-name="london">
      <class-name>
com.hazelcast.enterprise.wan.replication.WanBatchReplication</class-name>
      <queue-full-behavior>THROW_EXCEPTION</queue-full-behavior>
      <queue-capacity>1000</queue-capacity>
      <properties>
        <property name="batch.size">500</property>
        <property name="batch.max.delay.millis">1000</property>
        <property name="snapshot.enabled">>false</property>
        <property name="response.timeout.millis">60000</property>
        <property name="ack.type">ACK_ON_OPERATION_COMPLETE</property>
        <property name="endpoints">10.3.5.1:5701, 10.3.5.2:5701</property>
        <property name="group.password">london-pass</property>
        <property name="discovery.period">20</property>
        <property name="executorThreadCount">2</property>
      </properties>
    </wan-publisher>
  </wan-replication>
...
</hazelcast>

```

The `wan-publisher` element is used to configure the target cluster, i.e., to define how WAN events are sent to a specific endpoint. As mentioned above just before the configuration example, the endpoint can be a different cluster defined by static IP's or discovered using a cloud discovery mechanism. The `wan-publisher` element has the following attributes:

- `group-name`: Specifies the target cluster's group name for authentication on the target endpoint. It is mandatory to set this attribute.
- `publisher-id`: Specifies the publisher ID used for identifying the publisher. Setting this ID may be useful when the target group names are not unique for all of the WAN replication publishers in a single WAN replication scheme. It is optional to set this attribute. If this ID is not specified, the `group-name` will be used as a publisher ID.

And, the following are definitions of the configuration elements within `wan-publisher`:

- `name`: Name of your WAN Replication. This name is referenced in IMap or ICache configuration when you add WAN Replication for these data structures (using the element `<wan-replication-ref>` in the configuration of IMap or ICache).
- `class-name`: Name of the class implementation for the WAN replication.
- `queue-full-behavior`: Policy to be applied when WAN Replication event queues are full. Please see the [Queue Full Behavior section](#).
- `queue-capacity`: Size of the queue of events. Its default value is 10000. Please see the [Queue Capacity section](#).
- `batch.size`: Maximum size of events that are sent to the target cluster in a single batch. Its



default value is 500. Please see the [Batch Size section](#).

- `batch.max.delay.millis`: Maximum amount of time, in milliseconds, to be waited before sending a batch of events in case `batch.size` is not reached. Its default value is 1000 milliseconds. Please see the [Batch Maximum Delay section](#).
- `snapshot.enabled`: When set to `true`, only the latest events (based on key) are selected and sent in a batch. Its default value is `false`.
- `response.timeout.millis`: Time, in milliseconds, to be waited for the acknowledgment of a sent WAN event to target cluster. Its default value is 60000 milliseconds. Please see the [Response Timeout section](#).
- `ack.type`: Acknowledgment type for each target cluster. Please see the [Acknowledgment Types section](#).
- `endpoints`: IP addresses and ports of the cluster members for which the WAN replication is implemented. These endpoints are not necessarily the entire target cluster and WAN does not perform the discovery of other members in the target cluster. It only expects that these IP addresses (or at least some of them) are available.
- `group.password`: Configures target cluster's group password.

Other relevant properties are:

- `discovery.period`: Period in seconds in which WAN tries to reestablish connections to failed endpoints. Default is 10 seconds.
- `executorThreadCount`: The number of threads that the `WanBatchReplication` executor will have. The executor is used to send WAN events to the endpoints and ideally you want to have one thread per endpoint. If this property is omitted and you have specified the `endpoints` property, this will be the case. If necessary you can manually define the number of threads that the executor will use. Once the executor has been initialized there is thread affinity between the discovered endpoints and the executor threads - all events for a single endpoint will go through a single executor thread, preserving event order. It is important to determine which number of executor threads is a good value. Failure to do so can lead to performance issues - either contention on a too small number of threads or wasted threads that will not be performing any work.

And the following is the equivalent programmatic configuration snippet:

```

Config config = new Config();

WanReplicationConfig wrConfig = new WanReplicationConfig();
wrConfig.setName("my-wan-cluster-batch");

WanPublisherConfig publisherConfig = new WanPublisherConfig();
publisherConfig.setGroupName("london");
publisherConfig.setClassName("com.hazelcast.enterprise.wan.replication.WanBatchReplication");
publisherConfig.setQueueFullBehavior(WANQueueFullBehavior.THROW_EXCEPTION);
publisherConfig.setQueueCapacity(1000);

Map<String, Comparable> props = publisherConfig.getProperties();
props.put("batch.size", 500);
props.put("batch.max.delay.millis", 1000);
props.put("snapshot.enabled", false);
props.put("response.timeout.millis", 60000);
props.put("ack.type", WanAcknowledgeType.ACK_ON_OPERATION_COMPLETE.toString());
props.put("endpoints", "10.3.5.1:5701,10.3.5.2:5701");
props.put("group.password", "london-pass");
props.put("discovery.period", "20");
props.put("executorThreadCount", "2");

wrConfig.addWanPublisherConfig(publisherConfig);
config.addWanReplicationConfig(wrConfig);

```

Using this configuration, the cluster running in New York will replicate to Tokyo and London. The Tokyo and London clusters should have similar configurations if you want to run in Active-Active mode.

If the New York and London cluster configurations contain the `wan-replication` element and the Tokyo cluster does not, it means New York and London are active endpoints and Tokyo is a passive endpoint.

### Defining WAN Replication Using Discovery SPI

In addition to defining target cluster endpoints with static IP addresses, you can configure WAN to work with the discovery SPI and determine the endpoint IP addresses at runtime. This allows you to use WAN with endpoints on various cloud infrastructures (such as Amazon EC2 or GCP Compute) where the IP address is not known in advance. Typically you will use a readily available discovery SPI plugin such as [Hazelcast AWS EC2 discovery plugin](#), [Hazelcast GCP discovery plugin](#), or similar. For more advanced cases, you can provide your own discovery SPI implementation with custom logic for determining the WAN target endpoints such as looking up the endpoints in some service registry or even reading the endpoint addresses from a file.



When using the discovery SPI, WAN will always connect to the public address of the members returned by the discovery SPI implementation. This is opposite to the cluster membership mechanism using the discovery SPI where a member connects to a different member in the same cluster through its private address. Should you prefer for WAN to use the private address of the discovered member as well, please use the `discovery.useEndpointPrivateAddress` publisher property (see below).

Following is an example of setting up the WAN replication with the EC2 discovery plugin. You must have the [Hazelcast AWS EC2 discovery plugin](#) on the classpath.

```

<hazelcast>
...
  <wan-replication name="my-wan-cluster-batch">
    <wan-publisher group-name="london">
      <class-name>
com.hazelcast.enterprise.wan.replication.WanBatchReplication</class-name>
      <queue-full-behavior>THROW_EXCEPTION</queue-full-behavior>
      <queue-capacity>1000</queue-capacity>
      <properties>
        <property name="batch.size">500</property>
        <property name="batch.max.delay.millis">1000</property>
        <property name="snapshot.enabled">>false</property>
        <property name="response.timeout.millis">60000</property>
        <property name="ack.type">ACK_ON_OPERATION_COMPLETE</property>
        <property name="group.password">london-pass</property>
        <property name="discovery.period">20</property>
        <property name="maxEndpoints">5</property>
        <property name="executorThreadCount">5</property>
      </properties>
      <discovery-strategies>
        <discovery-strategy enabled="true" class=
"com.hazelcast.aws.AwsDiscoveryStrategy">
          <properties>
            <property name="access-key">test-access-key</property>
            <property name="secret-key">test-secret-key</property>
            <property name="region">test-region</property>
            <property name="iam-role">test-iam-role</property>
            <property name="host-header">ec2.test-host-header</property>
            <property name="security-group-
name</property>
            <property name="tag-key">test-tag-key</property>
            <property name="tag-value">test-tag-value</property>
            <property name="connection-timeout-seconds">10</property>
            <property name="hz-port">5701-5708</property>
          </properties>
        </discovery-strategy>
      </discovery-strategies>
    </wan-publisher>
  </wan-replication>
...
</hazelcast>

```

The `hz-port` property defines the port or the port range on which the target endpoint is running. The default port range 5701-5708 is used if this property is not defined. This is needed because the Amazon API which the AWS plugin uses does not provide the port on which Hazelcast is running, only the IP address. For some other discovery SPI implementations, this might not be necessary and it might discover the port as well, e.g., by looking up in a service registry.

The other properties are the same as when using the `aws` element. In case of EC2 discovery you can

configure the WAN replication using the `aws` element. You may use either of these, but not both at the same time.

```
<hazelcast>
...
  <wan-replication name="my-wan-cluster-batch">
    <wan-publisher group-name="london">
      <class-name>
com.hazelcast.enterprise.wan.replication.WanBatchReplication</class-name>
      <queue-full-behavior>THROW_EXCEPTION</queue-full-behavior>
      <queue-capacity>1000</queue-capacity>
      <properties>
        <property name="batch.size">500</property>
        <property name="batch.max.delay.millis">1000</property>
        <property name="snapshot.enabled">>false</property>
        <property name="response.timeout.millis">60000</property>
        <property name="ack.type">ACK_ON_OPERATION_COMPLETE</property>
        <property name="group.password">london-pass</property>
        <property name="discovery.period">20</property>
        <property name="discovery.useEndpointPrivateAddress">>false</property>
        <property name="maxEndpoints">5</property>
        <property name="executorThreadCount">5</property>
      </properties>
      <aws enabled="true">
        <access-key>my-access-key</access-key>
        <secret-key>my-secret-key</secret-key>
        <iam-role>dummy</iam-role>
        <region>us-west-1</region>
        <host-header>ec2.amazonaws.com</host-header>
        <security-group-name>hazelcast-sg</security-group-name>
        <tag-key>type</tag-key>
        <tag-value>hz-members</tag-value>
      </aws>
    </wan-publisher>
  </wan-replication>
...
</hazelcast>
```

You can refer to the [aws element](#) and the [Configuring Client for AWS](#) sections for the descriptions of above AWS configuration elements. Following are the definitions of additional configuration properties:

- `discovery.period`: Period in seconds in which WAN tries to discover new endpoints and reestablish connections to failed endpoints. Default is 10 seconds.
- `maxEndpoints`: Maximum number of endpoints that WAN will connect to when using a discovery mechanism to define endpoints. Default is `Integer.MAX_VALUE`. This property has no effect when static endpoint IPs are defined using the `endpoints` property.
- `executorThreadCount`: Number of threads that the `WanBatchReplication` executor will have. The

executor is used to send WAN events to the endpoints and ideally you want to have one thread per endpoint. If this property is omitted and you have specified the `endpoints` property, this will be the case. If, on the other hand, you are using WAN with the discovery SPI and you have not specified this property, the executor will be sized to the initial number of discovered endpoints. This can lead to performance issues if the number of endpoints changes in the future - either contention on a too small number of threads or wasted threads that will not be performing any work. To prevent this you can manually define the executor thread count. Once the executor has been initialized there is thread affinity between the discovered endpoints and the executor threads - all events for a single endpoint will go through a single executor thread, preserving event order.

- `discovery.useEndpointPrivateAddress`: Determines whether the WAN connection manager should connect to the endpoint on the private address returned by the discovery SPI. By default this property is `false` which means the WAN connection manager will always use the public address.

You can also define the WAN publisher with discovery SPI using the programmatic configuration:

```

Config config = new Config();

WanReplicationConfig wrConfig = new WanReplicationConfig();
wrConfig.setName("my-wan-cluster-batch");

WanPublisherConfig publisherConfig = new WanPublisherConfig();
publisherConfig.setGroupName("london");
publisherConfig.setClassName("com.hazelcast.enterprise.wan.replication.WanBatchReplication");
publisherConfig.setQueueFullBehavior(WANQueueFullBehavior.THROW_EXCEPTION);
publisherConfig.setQueueCapacity(1000);

Map<String, Comparable> props = publisherConfig.getProperties();
props.put("batch.size", 500);
props.put("batch.max.delay.millis", 1000);
props.put("snapshot.enabled", false);
props.put("response.timeout.millis", 60000);
props.put("ack.type", WanAcknowledgeType.ACK_ON_OPERATION_COMPLETE.toString());
props.put("group.password", "london-pass");
props.put("discovery.period", "20");
props.put("executorThreadCount", "2");

DiscoveryConfig discoveryConfig = new DiscoveryConfig();

DiscoveryStrategyConfig discoveryStrategyConfig = new DiscoveryStrategyConfig(
    "com.hazelcast.aws.AwsDiscoveryStrategy");
discoveryStrategyConfig.addProperty("access-key", "test-access-key");
discoveryStrategyConfig.addProperty("secret-key", "test-secret-key");
discoveryStrategyConfig.addProperty("region", "test-region");
discoveryStrategyConfig.addProperty("iam-role", "test-iam-role");
discoveryStrategyConfig.addProperty("host-header", "ec2.test-host-header");
discoveryStrategyConfig.addProperty("security-group-name", "test-security-group-name");
discoveryStrategyConfig.addProperty("tag-key", "test-tag-key");
discoveryStrategyConfig.addProperty("tag-value", "test-tag-value");
discoveryStrategyConfig.addProperty("hz-port", 5702);

discoveryConfig.addDiscoveryStrategyConfig(discoveryStrategyConfig);
publisherConfig.setDiscoveryConfig(discoveryConfig);
wrConfig.addWanPublisherConfig(publisherConfig);
config.addWanReplicationConfig(wrConfig);

```

### 22.1.2. WanBatchReplication Implementation

Hazelcast offers `WanBatchReplication` implementation for the WAN replication.

As you see in the above configuration examples, this implementation is configured using the `class-name` element (in the declarative configuration) or the method `setClassName` (in the programmatic configuration).

The implementation `WanBatchReplication` waits until:

- a pre-defined number of replication events are generated, (please refer to the [Batch Size section](#)).
- or a pre-defined amount of time is passed (please refer to the [Batch Maximum Delay section](#)).



`WanNoDelayReplication` implementation has been removed. You can still achieve this behavior by setting the batch size to `1` while configuring your WAN replication.

### 22.1.3. Configuring WAN Replication for IMap and ICache

You can configure the WAN replication for Hazelcast's IMap and ICache data structures. To enable WAN replication for an IMap or ICache instance, you can use the `wan-replication-ref` element. Each IMap and ICache instance can have different WAN replication configurations.

#### Enabling WAN Replication for IMap:

Imagine you have different distributed maps, however only one of those maps should be replicated to a target cluster. To achieve this, configure the map that you want replicated by adding the `wan-replication-ref` element in the map configuration as shown below.

```
<hazelcast>
  <wan-replication name="my-wan-cluster">
    ...
  </wan-replication>
  <map name="my-shared-map">
    <wan-replication-ref name="my-wan-cluster">
      <merge-policy>com.hazelcast.map.merge.PassThroughMergePolicy</merge-policy>
      <republishing-enabled>>false</republishing-enabled>
    </wan-replication-ref>
  </map>
  ...
</hazelcast>
```

The following is the equivalent programmatic configuration:



```

Config config = new Config();

WanReplicationConfig wrConfig = new WanReplicationConfig();
wrConfig.setName("my-wan-cluster");

config.addWanReplicationConfig(wrConfig);

WanReplicationRef wanRef = new WanReplicationRef();
wanRef.setName("my-wan-cluster");
wanRef.setMergePolicy(PassThroughMergePolicy.class.getName());
wanRef.setRepublishingEnabled(false);
config.getMapConfig("my-shared-map").setWanReplicationRef(wanRef);
}
}

```

You see that we have `my-shared-map` configured to replicate itself to the cluster targets defined in the earlier `wan-replication` element.

`wan-replication-ref` has the following elements;

- **name**: Name of `wan-replication` configuration. IMap or ICache instance uses this `wan-replication` configuration.
- **merge-policy**: Resolve conflicts that are occurred when target cluster already has the replicated entry key.
- **republishing-enabled**: When enabled, an incoming event to a member is forwarded to target cluster of that member. Enabling the event republishing is useful in a scenario where cluster A replicates to cluster B and cluster B replicates to cluster C. You do not need to enable republishing when all your clusters replicate to each other.

When using Active-Active Replication, multiple clusters can simultaneously update the same entry in a distributed data structure. You can configure a merge policy to resolve these potential conflicts, as shown in the above example configuration (using the `merge-policy` sub-element under the `wan-replication-ref` element).

Hazelcast provides the following merge policies for IMap:

- `com.hazelcast.map.merge.PutIfAbsentMapMergePolicy`: Incoming entry merges from the source map to the target map if it does not exist in the target map.
- `com.hazelcast.map.merge.HigherHitsMapMergePolicy`: Incoming entry merges from the source map to the target map if the source entry has more hits than the target one.
- `com.hazelcast.map.merge.PassThroughMergePolicy`: Incoming entry merges from the source map to the target map unless the incoming entry is not null.
- `com.hazelcast.map.merge.LatestUpdateMapMergePolicy`: Incoming entry merges from the source map to the target map if the source entry has been updated more recently than the target entry. Please note that this merge policy can only be used when the clusters' clocks are in sync.

NOTE When using WAN replication, please note that only key based events are replicated to the

target cluster. Operations like `clear`, `destroy` and `evictAll` are NOT replicated.

### Enabling WAN Replication for ICache:

The following is a declarative configuration example for enabling WAN Replication for ICache:

```
<wan-replication name="my-wan-cluster">
  ...
</wan-replication>
<cache name="my-shared-cache">
  <wan-replication-ref name="my-wan-cluster">
    <merge-policy>com.hazelcast.cache.merge.PassThroughCacheMergePolicy</merge-
policy>
    <republishing-enabled>true</republishing-enabled>
  </wan-replication-ref>
</cache>
```

The following is the equivalent programmatic configuration:

```
Config config = new Config();

WanReplicationConfig wrConfig = new WanReplicationConfig();
wrConfig.setName("my-wan-cluster");

config.addWanReplicationConfig(wrConfig);

WanReplicationRef cacheWanRef = new WanReplicationRef();
cacheWanRef.setName("my-wan-cluster");
cacheWanRef.setMergePolicy("com.hazelcast.cache.merge.PassThroughCacheMergePolicy");
cacheWanRef.setRepublishingEnabled(true);
config.getCacheConfig("my-shared-cache").setWanReplicationRef(cacheWanRef);
```



Caches that are created dynamically do not support WAN replication functionality. Cache configurations should be defined either declaratively (by XML) or programmatically on both source and target clusters.

Hazelcast provides the following merge policies for ICache:

- `com.hazelcast.cache.merge.HigherHitsCacheMergePolicy`: Incoming entry merges from the source cache to the target cache if the source entry has more hits than the target one.
- `com.hazelcast.cache.merge.PassThroughCacheMergePolicy`: Incoming entry merges from the source cache to the target cache unless the incoming entry is not null.

#### 22.1.4. Batch Size

The maximum size of events that are sent in a single batch can be changed depending on your needs. Default value for batch size is `500`.

Batch size can be set for each target cluster by modifying related `WanPublisherConfig`.

Below is the declarative configuration for changing the value of the property:

```
...
<wan-replication name="my-wan-cluster">
  <wan-publisher group-name="london">
    ...
    <properties>
      ...
      <property name="batch.size">1000</property>
      ...
    </properties>
    ...
  </wan-publisher>
</wan-replication>
...
```

And, following is the equivalent programmatic configuration:

```
...
WanReplicationConfig wanConfig = config.getWanReplicationConfig("my-wan-cluster");
WanPublisherConfig publisherConfig = new WanPublisherConfig();
...
Map<String, Comparable> props = publisherConfig.getProperties();
props.put("batch.size", 1000);
wanConfig.addWanPublisherConfig(publisherConfig);
...
```



`WanNoDelayReplication` implementation has been removed. You can still achieve this behavior by setting the batch size to `1` while configuring your WAN replication.

### 22.1.5. Batch Maximum Delay

When using `WanBatchReplication` if the number of WAN replication events generated does not reach `Batch Size`, they are sent to the target cluster after a certain amount of time is passed. You can set this duration in milliseconds using this batch maximum delay configuration. Default value of for this duration is 1 second (1000 milliseconds).

Maximum delay can be set for each target cluster by modifying related `WanPublisherConfig`.

You can change this property using the declarative configuration as shown below.

```

...
<wan-replication name="my-wan-cluster">
  <wan-publisher group-name="london">
    ...
    <properties>
      ...
      <property name="batch.max.delay.millis">2000</property>
      ...
    </properties>
    ...
  </wan-publisher>
</wan-replication>
...

```

And, the following is the equivalent programmatic configuration:

```

...
WanReplicationConfig wanConfig = config.getWanReplicationConfig("my-wan-cluster");
WanPublisherConfig publisherConfig = new WanPublisherConfig();
...
Map<String, Comparable> props = publisherConfig.getProperties();
props.put("batch.max.delay.millis", 2000);
wanConfig.addWanPublisherConfig(publisherConfig);
...

```

### 22.1.6. Response Timeout

After a replication event is sent to the target cluster, the source member waits for an acknowledgement of the delivery of the event to the target. If the confirmation is not received inside a timeout duration window, the event is resent to the target cluster. Default value of this duration is `60000` milliseconds.

You can change this duration depending on your network latency for each target cluster by modifying related `WanPublisherConfig`.

Below is an example of declarative configuration:

```

...
<wan-replication name="my-wan-cluster">
  <wan-publisher group-name="london">
    <properties>
      <property name="response.timeout.millis">5000</property>
    </properties>
  </wan-publisher>
</wan-replication>
...

```

And, the following is the equivalent programmatic configuration:

```
...
WanReplicationConfig wanConfig = config.getWanReplicationConfig("my-wan-cluster");
WanPublisherConfig publisherConfig = new WanPublisherConfig();
...
Map<String, Comparable> props = publisherConfig.getProperties();
props.put("response.timeout.millis", 5000);
wanConfig.addWanPublisherConfig(publisherConfig);
...
```

### 22.1.7. Queue Capacity

For huge clusters or high data mutation rates, you might need to increase the replication queue size. The default queue size for replication queues is `10000`. This means, if you have heavy put/update/remove rates, you might exceed the queue size so that the oldest, not yet replicated, updates might get lost. Note that a separate queue is used for each WAN Replication configured for IMap and ICache.

Queue capacity can be set for each target cluster by modifying related `WanPublisherConfig`.

You can change this property using the declarative configuration as shown below.

```
...
<wan-replication name="my-wan-cluster">
  <wan-publisher group-name="london">
    ...
    <queue-capacity>15000</queue-capacity>
    ...
  </target-cluster>
</wan-replication>
...
```

And, the following is the equivalent programmatic configuration:

```
...
WanReplicationConfig wanConfig = config.getWanReplicationConfig("my-wan-cluster");
WanPublisherConfig publisherConfig = new WanPublisherConfig();
...
publisherConfig.setQueueCapacity(15000);
wanConfig.addWanPublisherConfig(publisherConfig);
...
```

Note that you can clear a member's WAN replication event queue. It can be initiated through Management Center's [Clear Queues action](#) or Hazelcast's REST API. Below is the URL for its REST call:

```
http://member_ip:port/hazelcast/rest/mancenter/wan/clearWanQueues
```

This may be useful, for instance, to release the consumed heap if you know that the target cluster is being shut down, decommissioned, put out of use and it will never come back. Or, when a failure happens and queues are not replicated anymore, you could clear the queues using this clearing action.

### 22.1.8. Queue Full Behavior

In the previous Hazelcast releases, WAN replication was dropping the new events if WAN replication event queues are full. This behavior is configurable starting with Hazelcast 3.6.

There are following supported behaviors:

- **DISCARD\_AFTER\_MUTATION**: If you select this option, the new WAN events generated by the member are dropped and not replicated to the target cluster when the WAN event queues are full.
- **THROW\_EXCEPTION**: If you select this option, the WAN queue size is checked before each supported mutating operation (like `IMap.put()`, `ICache.put()`). If one of the queues of target cluster is full, `WANReplicationQueueFullException` is thrown and the operation is not allowed.
- **THROW\_EXCEPTION\_ONLY\_IF\_REPLICATION\_ACTIVE**: Its effect is similar to that of **THROW\_EXCEPTION**. But, it throws exception only when WAN replication is active. It discards the new events if WAN replication is stopped.

The following is an example configuration:

```
<wan-replication name="my-wan-cluster">
  <wan-publisher group-name="test-cluster-1">
    ...
    <queue-full-behavior>DISCARD_AFTER_MUTATION</queue-full-behavior>
  </wan-publisher>
</wan-replication>
```



`queue-full-behavior` configuration is optional. Its default value is `DISCARD_AFTER_MUTATION`.

### 22.1.9. Event Filtering API

Starting with Hazelcast 3.6, WAN replication allows you to intercept WAN replication events before they are placed to WAN event replication queues by providing a filtering API. Using this API, you can monitor WAN replication events of each data structure separately.

You can attach filters to your data structures using `filter` property of `wan-replication-ref` configuration inside `hazelcast.xml` as shown in the following example configuration. You can also configure it using the programmatic configuration.

```

<hazelcast>
  <map name="testMap">
    <wan-replication-ref name="test">
      <filters>
        <filter-impl>com.example.SampleFilter</filter-impl>
        <filter-impl>com.example.SampleFilter2</filter-impl>
      </filters>
    </wan-replication-ref>
  </map>
</hazelcast>

```

As shown in the above configuration, you can define more than one filter. Filters are called in the order that they are introduced. A WAN replication event is only eligible to publish if it passes all the filters.

Map and Cache have different filter interfaces: `MapWanEventFilter` and `CacheWanEventFilter`. Both of these interfaces have the method `filter` which takes the following parameters:

- `mapName/cacheName`: Name of the related data structure.
- `entryView`: `EntryView` or `CacheEntryView` depending on the data structure.
- `eventType`: Enum type - `UPDATED(1)`, `REMOVED(2)` or `LOADED(3)` - depending on the event.



`LOADED` events are filtered out and not replicated to target cluster.

### 22.1.10. Acknowledgment Types

Starting with Hazelcast 3.6, WAN replication supports different acknowledgment (ACK) types for each target cluster group. You can choose from 2 different ACK type depending on your consistency requirements. The following ACK types are supported:

- `ACK_ON_RECEIPT`: A batch of replication events is considered successful as soon as it is received by the target cluster. This option does not guarantee that the received event is actually applied but it is faster.
- `ACK_ON_OPERATION_COMPLETE`: This option guarantees that the event is received by the target cluster and it is applied. It is more time consuming. But it is the best way if you have strong consistency requirements.

Following is an example configuration:

```

<wan-replication name="my-wan-cluster">
  <wan-publisher group-name="test-cluster-1">
    ...
    <properties>
      <property name="ack.type">ACK_ON_OPERATION_COMPLETE</property>
    </properties>
  </wan-publisher>
</wan-replication>

```



`ack.type` configuration is optional. Its default value is `ACK_ON_RECEIPT`.

### 22.1.11. Synchronizing WAN Target Cluster

Starting with Hazelcast 3.7 you can initiate a synchronization operation on an IMap for a specific target cluster. Synchronization operation sends all the data of an IMap to a target cluster to align the state of target IMap with source IMap. Synchronization is useful if two remote clusters lost their synchronization due to WAN queue overflow or in restart scenarios.

Synchronization can be initiated through [Management Center](#) and Hazelcast's REST API.

Below is the URL for the REST call;

```
http://member_ip:port/hazelcast/rest/mancenter/wan/sync/map
```

You need to add parameters to the request in the following order separated by "&";

- Name of the WAN replication configuration
- Target group name
- Map name to be synchronized

Assume that you have configured an IMap with a WAN replication configuration as follows:

```

<wan-replication name="my-wan-cluster">
  <wan-publisher group-name="istanbul">
    <class-name>
com.hazelcast.enterprise.wan.replication.WanBatchReplication</class-name>
    ...
  </wan-publisher>
</wan-replication>
...
<map name="my-map">
  <wan-replication-ref name="my-wan-cluster">
    <merge-policy>com.hazelcast.map.merge.PassThroughMergePolicy</merge-policy>
  </wan-replication-ref>
</map>

```



Then, a sample CURL command to initiate the synchronization for "my-map" would be as follows:

```
curl -H "Content-type: text/plain" -X POST -d "my-wan-cluster&istanbul&my-map" --URL http://127.0.0.1:5701/hazelcast/rest/mancenter/wan/sync/map
```



#### *Synchronizing All Maps*

You can also use the following URL in your REST call if you want to synchronize all the maps in source and target cluster:

[http://member\\_ip:port/hazelcast/rest/mancenter/wan/sync/allmaps](http://member_ip:port/hazelcast/rest/mancenter/wan/sync/allmaps)



Synchronization for a target cluster operates only with the data residing in the memory. Therefore, evicted entries will not be synchronized, not even if `MapLoader` is configured.

## 22.1.12. WAN Replication Failure Detection and Recovery

The failure detection and recovery mechanisms in WAN handle failures during WAN replication and they closely interact with the list of endpoints that WAN is replicating to. There might be some small differences when using static endpoints or the discovery SPI but here we will outline the general mechanism of failure detection and recovery.

### WAN Target Endpoint List

The WAN connection manager maintains a list of public addresses that it can replicate to at any moment. This list may change over time as failures are detected or as new addresses are discovered when using the discovery SPI. The connection manager does not eagerly create connections to these addresses as they are added to the list to avoid overloading the endpoint with connections from all members using the same configuration. It will try and connect to the endpoint just before WAN events are about to be transmitted. This means that if there are no updates on the map or cache using WAN replication, there will be no WAN events and the connection will not be established to the endpoint.

When more than one endpoint is configured, traffic will be load balanced between them using the partition, so that the same partitions are always sent to the same target member, ensuring ordering by partition.

### WAN Failure Detection

If using the Hazelcast IMDG Enterprise edition class `WanBatchReplication` (see the [Defining WAN replication section](#)), the WAN replication will catch any exceptions when sending the WAN events to the endpoint. In the case of an exception, the endpoint will be removed from the endpoint list to which WAN replicates and the WAN events will be resent to a different address. The replication will be retried until it is successful.

### WAN Endpoint Recovery

Periodically the WAN connection manager will try and "rediscover" new endpoints. The period is

10 seconds by default but configurable with the `discovery.period` property (see the [Defining WAN replication section](#)).

The discovered endpoints depend on the configuration used to define WAN replication. If using static WAN endpoints (by using the `endpoints` property), the discovered endpoints are always the same and are equal to the values defined in the configuration. If using discovery SPI with WAN, the discovered endpoints may be different each time.

When the discovery returns a list of endpoints (addresses), the WAN target endpoint list is updated. Newly discovered endpoints are added and endpoints which are no longer in the discovered list are removed. Newly discovered endpoints may include addresses to which WAN replication has previously failed. This means that once a new WAN event is about to be sent, a connection will be reestablished to the previously failed endpoint and WAN replication will be retried. The endpoint can later be again removed from the target endpoint list if the replication again encounters failure.

### 22.1.13. WAN Replication Additional Information

Each cluster in WAN topology has to have a unique `group-name` property for a proper handling of forwarded events.

Starting with Hazelcast 3.6, WAN replication backs up its event queues to other members to prevent event loss in case of member failures. WAN replication's backup mechanism depends on the related data structures' backup operations. Note that, WAN replication is supported for IMap and ICache. That means, as far as you set a backup count for your IMap or ICache instances, WAN replication events generated by these instances are also replicated.

There is no additional configuration to enable/disable WAN replication event backups.

## 22.2. Delta WAN Synchronization

Hazelcast clusters connected over WAN can go out-of-sync because of various reasons such as member failures and concurrent updates. To overcome the out-of-sync issue, Hazelcast has the default [WAN synchronization](#) feature, through which the maps in different clusters are synced by transferring all entries from the source to the target cluster. This may be not efficient since some of the entries have remained unchanged on both clusters and do not require to be transferred. Also, for the entries to be transferred, they need to be copied to on-heap on the source cluster. This may cause spikes in the heap usage, especially if using large off-heap stores.

Besides the default WAN synchronization, Hazelcast provides Delta WAN Synchronization which uses [Merkle tree](#) for the same purpose. It is a data structure used for efficient comparison of the difference in the contents of large data structures. The precision of this comparison is defined by Merkle tree's depth. Merkle tree hash exchanges can detect inconsistencies in the map data and synchronize only the different entries when using WAN synchronization, instead of sending all the map entries.



Currently, Delta WAN Synchronization is implemented only for Hazelcast IMap. It will also be implemented for ICache in the future releases.

## 22.2.1. Requirements

To be able to use Delta WAN synchronization, the following must be met:

- Source and target cluster versions must be at least Hazelcast 3.11.
- Both clusters must have the same number of partitions.
- Both clusters must use the same partitioning strategy.
- Both clusters must have the Merkle tree structure enabled.

## 22.2.2. Using Delta WAN Synchronization

To be able to use Delta WAN synchronization for a Hazelcast data structure:

1. Configure the WAN synchronization mechanism for your WAN publisher so that it uses the Merkle tree: If configuring declaratively, you can use the `consistency-check-strategy` sub-element of the `wan-sync` element. If configuring programmatically, you can use the setter of the `WanSyncConfig` object.
2. Bind that WAN synchronization configuration to the data structure (currently IMap): Simply set the WAN replication reference of your map to the name of the WAN replication configuration which uses the Merkle tree.

Following is a declarative configuration example of the above:

```
<map name="myMap">
  <wan-replication-ref name="wanReplicationScheme">
    ...
  </wan-replication-ref>
  ...
</map>
...
...
<wan-replication name="wanReplicationScheme">
  <wan-publisher group-name="groupName">
    <class-name>...</class-name>
    <wan-sync>
      <consistency-check-strategy>MERKLE_TREES</consistency-check-strategy>
    </wan-sync>
    ...
  </wan-publisher>
</wan-replication>
```

Here, the element `consistency-check-strategy` sets the strategy for checking the consistency of data between the source and target clusters. You must initiate the WAN synchronization (via Management Center or REST API as explained in [Synchronizing WAN clusters](#)) to let this strategy reconcile the inconsistencies. The element `consistency-check-strategy` has currently two values:

- **NONE**: Means that there will be no consistency checks. This is the default value.

- **MERKLE\_TREES**: Means that WAN synchronization will use Merkle tree structure.

### 22.2.3. Configuring Delta WAN Synchronization

You can configure Delta WAN Synchronization declaratively using the `merkle-tree` element or programmatically using the `MerkleTreeConfig` object.

Following is a declarative configuration example showing how to enable Delta WAN Synchronization, bind it to a Hazelcast data structure (an IMap in the below case) and specify its depth.

```
<merkle-tree enabled="true">
  <mapName>someMap</mapName>
  <depth>5</depth>
</merkle-tree>
```

Here are the descriptions of sub-elements and attributes:

- **enabled**: Specifies whether the Merkle tree structure is enabled. Its default value is `true`.
- **mapName**: Specifies the name of the map for which the Merkle tree structure is used.
- **depth**: Specifies the depth of Merkle tree. Valid values are between 2 and 27 (exclusive). Its default value is `10`.
  - A larger depth means that a data synchronization mechanism is able to pinpoint a smaller subset of the data structure (e.g., IMap) contents in which a change has occurred. This causes the synchronization mechanism to be more efficient. However, keep in mind that a large depth means that the Merkle tree will consume more memory. As the comparison mechanism is iterative, a larger depth also prolongs the comparison duration. Therefore, it is recommended not to have large tree depths if the latency of the comparison operation is high.
  - A smaller depth means that the Merkle tree is shallower and the data synchronization mechanism transfers larger chunks of the data structure (e.g., IMap) in which a possible change has happened. As you can imagine, a shallower Merkle tree will consume less memory.

Following is a declarative example including the Merkle tree configuration.

```

<map name="myMap">
  <wan-replication-ref name="wanReplicationScheme">
    ...
  </wan-replication-ref>
  ...
</map>
...
<merkle-tree enabled="true">
  <mapName>myMap</mapName>
  <depth>10</depth>
</merkle-tree>
...
<wan-replication name="wanReplicationScheme">
  <wan-publisher group-name="groupName">
    <class-name>...</class-name>
    <wan-sync>
      <consistency-check-strategy>MERKLE_TREES</consistency-check-strategy>
    </wan-sync>
    ...
  </wan-publisher>
</wan-replication>

```



If you do not specifically configure the `merkle-tree` in your Hazelcast configuration, Hazelcast uses the default Merkle tree structure values (i.e., it is enabled by default and its default depth is 10) when there is a WAN publisher using the Merkle tree (i.e., `consistency-check-strategy` for a WAN replication configuration is set as `MERKLE_TREES` and there is a data structure using that WAN replication configuration).



Merkle trees are created for each partition holding IMap data. Therefore, increasing the partition count also increases the efficiency of the Delta WAN Synchronization.

#### 22.2.4. The Process

Synchronizing the maps based on Merkle trees consists of two phases:

1. *Consistency check*: Process of exchanging and comparing the hashes stored in the Merkle tree structures in the source and target clusters. The check starts with the root node and continues recursively with the children with different hash codes. Both sides send the children of the nodes that the other side sent, hence the comparison is done by `depth/2` steps. After this check, the tree leaves holding different entries are identified.
2. *Synchronization*: Process of transferring the entries belong to the leaves identified by the *consistency check* from the source to target cluster. On the target cluster the configured merge policy is applied for each entry that is in both the source and target clusters.



If you only need the differences between the clusters, you can trigger the consistency check without performing synchronization.

### 22.2.5. Memory Consumption

Since Merkle trees are built for each partition and each map, the memory overhead of the trees with high entry count and deep trees can be significant. The trees are maintained on-heap, therefore - besides the memory consumption - garbage collection could be another concern. Make sure the configuration is tested with realistic data size before deployed in production.

The table below shows a few examples for what the memory overhead could be.

Table 5. Merkle trees memory overhead for a member

Entries Stored	Partitions Owned	Entries per Leaf	Depth	Memory Overhead
1M	271	7	10	57 MB
1M	271	1	13	97 MB
10M	271	72	10	412 MB
10M	271	9	13	453 MB
10M	5009	4	10	577 MB
10M	5009	1	12	900 MB
25M	5009	10	10	1986 MB
25M	5009	1	13	2740 MB

### 22.2.6. Defining the Depth

The efficiency of the Delta WAN Synchronization (WAN synchronization based on Merkle trees) is determined by the average number of entries per the tree leaves that is proportionate to the number of entries in the map. The bigger this average the more entries are getting synchronized for the same difference. Raising the depth decreases this average at the cost of increasing the memory overhead.

This average can be calculated for a map as  $avgEntriesPerLeaf = mapEntryCount / totalLeafCount$ , where  $totalLeafCount = partitionCount * 2^{depth-1}$ . The ideal value is 1, however this may come at significant memory overhead as shown in the table above.

In order to specify the tree depth, a trade-off between memory consumption and effectiveness might be needed.

Even if the map is huge and the Merkle trees are configured to be relatively shallow, the Merkle tree based synchronization may be leveraged if only a small subset of the whole map is expected to be synchronized. The table below illustrates the efficiency of the Merkle tree based synchronization compared to the default synchronization mechanism.

Table 6. Efficiency examples

Map entry count	Depth	Memory consumption	Avg. entries / leaf	Difference count	Entries synced	Efficiency
10M	11	685 MB	2	5M	10M	0%
10M	12	900 MB	1	5M	5M	100%
10M	10	577 MB	4	1M	4M	150%
10M	8	497 MB	16	10K	160K	6150%
10M	12	900 MB	1	10K	10K	99900%

The "Difference count" column shows the number of the entries different in the source and target clusters. This is the minimum number of entries that need to be synchronized to make the clusters consistent. The "Entries synced" column shows how many entries are synchronized in the given case, calculated as "Entries synced" = "Difference count" \* "Avg. entries / leaf".

As shown in the last two rows, the Merkle tree based synchronization transfers significantly less entries than what the default mechanism does even with 8 deep trees. The efficiency with depth 12 is even better but consumes much more memory.



The averages in the table are calculated with 5009 partitions.



The average entries per leaf number above assumes perfect distribution of the entries amongst the leaves. Since this is typically not true in real-life scenarios the efficiency can be slightly worse. The statistics section below describes how to get the actual average for the leaves involved in the synchronization.

### 22.2.7. REST API

The two phases of the Merkle tree based synchronization can be triggered by a REST call, as it can be done with the default synchronization.

The URL for the consistency check REST call:

```
http://member_ip:port/hazelcast/rest/mancenter/wan/consistencyCheck/map
```

The URL for the synchronization REST call - the same as it is for the default synchronization:

```
http://member_ip:port/hazelcast/rest/mancenter/wan/sync/map
```

You need to add parameters to the request in both cases in the following order separated by "&";

- Name of the WAN replication configuration
- Target group name
- Map name to be synchronized



You can also use the following URL in your REST call if you want to synchronize all the maps in source and target cluster: [http://member\\_ip:port/hazelcast/rest/management/wan/sync/allmaps](http://member_ip:port/hazelcast/rest/management/wan/sync/allmaps)



Consistency check can be triggered only for one map.

### 22.2.8. Statistics

The consistency check and the synchronization both write statistics into the diagnostics subsystem and send it to the Management Center. The following reported fields can be used to reason about the efficiency of the configuration.

Consistency check reports the number of the

- Merkle tree nodes checked,
- Merkle tree nodes found to be different,
- entries needed to be synchronized to make the clusters consistent.

Synchronization reports the

- duration of the synchronization,
- number of the entries synchronized,
- average number of the entries per tree leaves in the synchronized leaves.

## 22.3. Hazelcast WAN Replication with Solace

Plugin

This section explains how you can integrate Hazelcast's WAN replication with [Solace](#) messaging platform. With this integration, you can publish and consume WAN replication events to/from Solace appliances.

Solace combines with Hazelcast to drive efficiencies in the processing of global data workloads. This joint solution enables multi-cloud and hybrid-cloud replication of Hazelcast clusters. Please see [Hazelcast-Solace partnership](#) for more information.

### 22.3.1. Enabling Integration

To publish and consume WAN replication events on Solace appliances, Hazelcast WAN replication has the following classes:

- `SolaceWanPublisher`
- `SolaceWanConsumer`

You can register these classes using the configuration elements `<wan-publisher>` and `<wan-consumer>` while configuring your WAN replication. `SolaceWanPublisher` and `SolaceWanConsumer` are included in the `hazelcast-solace` library which can be found in following Maven coordinates:



```
<dependency>
  <groupId>com.hazelcast</groupId>
  <artifactId>hazelcast-solace</artifactId>
  <version>1.0.0</version>
</dependency>
```



The `hazelcast-solace` artifact is not available in central Maven repository, but in Hazelcast's repository on the CloudBees platform. Please refer to the [Installing Hazelcast IMDG Enterprise](#) section for information on how to configure this repository.

Please see the following sections for configuration details.

### 22.3.2. Configuring Publisher

Following is an example declarative configuration for the publisher side:

```
<wan-replication name="AtoB">
  <wan-publisher group-name="clusterB">
    <class-name>com.hazelcast.enterprise.wan.solace.SolaceWanPublisher</class-
name>
    <properties>
      <property name="host">192.168.2.66</property>
      <property name="vpn.name">YOUR_VPN_NAME</property>
      <property name="username">admin</property>
      <property name="password">YOUR_PASSWORD</property>
      <property name="topic.base.name">BaseTopic</property>
      <property name="queue.name">Q/hz/clusterA</property>
      <property name="initial.queue.mapping.enabled">true</property>
    </properties>
  </wan-publisher>
</wan-replication>
```

Descriptions of the properties are as follows:

- **class-name**: Full class name of Solace WAN publisher, i.e., `com.hazelcast.enterprise.wan.solace.SolaceWanPublisher`
- **host**: IP address of the Solace host machine. It can be in the format "IP address:Port number". It is a mandatory property.
- **vpn.name**: Name of the Solace VPN. It is an optional property.
- **username**: Username for the Solace host. It is a mandatory property.
- **password**: Password for the Solace host. It is an optional property.
- **topic.base.name**: Base topic name to use while publishing events to Solace appliance. If not defined, the members will publish to topics using the format "T/hz/[cluster-group-name]/partitionId". If defined, the format "[topic.base.name]/partitionId" will be used. It is an

optional property.

- **queue.name**: Name of the queue to be used in topic-to-queue mapping. This property is only valid if the property **initial.queue.mapping.enabled** is set to "true". Default queue name is "Q/hz/[cluster-group-name].
- **initial.queue.mapping.enabled**: Decides if a default topic-to-queue mapping should be performed on the publisher side. When enabled, it tries to provide a queue, whose name is defined by the property **queue.name**, and all topics that are generated by this instance is mapped to this queue. When disabled, you should perform this mapping manually. It is enabled by default.

### 22.3.3. Configuring Consumer

Following is an example declarative configuration for the consumer side:

```
<wan-replication name="AtoB">
  <wan-consumer>
    <class-name>com.hazelcast.enterprise.wan.solace.SolaceWanConsumer</class-name>
    <persist-wan-replicated-data>>false</persist-wan-replicated-data>
    <properties>
      <property name="host">192.168.2.66</property>
      <property name="vpn.name">YOUR_VPN_NAME</property>
      <property name="username">admin</property>
      <property name="password">YOUR_PASSWORD</property>
      <property name="queue.name">Q/hz/clusterA</property>
    </properties>
  </wan-consumer>
</wan-replication>
```

Descriptions of the properties are as follows:

- **class-name**: Full class name of Solace WAN consumer, i.e., **com.hazelcast.enterprise.wan.solace.SolaceWanConsumer**
- **persist-wan-replicated-data**: When true, an incoming event over WAN replication can be persisted to a data store, otherwise it will not be persisted. Default value is false.
- **host**: IP address of the Solace host machine. It can be in the format "IP address:Port number". It is a mandatory property.
- **vpn.name**: Name of the Solace VPN. It is an optional property.
- **username**: Username for the Solace host. It is a mandatory property.
- **password**: Password for the Solace host. It is an optional property.
- **queue.name**: Name of the queue to be polled by the consumer. It is a mandatory property.

### 22.3.4. Additional Information

You can find code samples at [hazelcast-code-samples](#) repository.



You can download the white paper **Hazelcast WAN Replication with Solace** from [Hazelcast.com](https://www.hazelcast.com).

## 23. OSGI

This chapter explains how Hazelcast is supported on OSGI (Open Service Gateway Initiatives) environments.

### 23.1. OSGI Support

Hazelcast bundles provide OSGI services so that Hazelcast users can manage (create, access, shutdown) Hazelcast instances through these services on OSGI environments. When you enable the property `hazelcast.osgi.start` (default is disabled), when an Hazelcast OSGI service is activated, a default Hazelcast instance is created automatically.

Created Hazelcast instances can be served as an OSGI service that the other Hazelcast bundles can access. Registering created Hazelcast instances behavior is enabled by default; you can disable it using the property `hazelcast.osgi.register.disabled`.

Each Hazelcast bundle provides a different OSGI service. Their instances can be grouped (clustered) together to prevent possible compatibility issues between different Hazelcast versions/bundles. This grouping behavior is enabled by default and you disable it using the property `hazelcast.osgi.grouping.disabled`.

Hazelcast OSGI service's lifecycle (and the owned/created instances's lifecycles) is the same with the owner Hazelcast bundles. When the bundle is stopped (deactivated), the owned service and Hazelcast instances are also deactivated/shutdown and deregistered automatically. When the bundle is re-activated, its service is registered again.

The Hazelcast IMDG Enterprise JAR package is also an OSGI bundle like the Hazelcast Open Source JAR package.

### 23.2. API

**HazelcastOSGiService:** Contract point for Hazelcast services on top of OSGI. Registered to `org.osgi.framework.BundleContext` as the OSGI service so the other bundles can access and use Hazelcast on the OSGI environment through this service.

**HazelcastOSGiInstance:** Contract point for `HazelcastInstance` implementations based on OSGI service. `HazelcastOSGiService` provides proxy Hazelcast instances typed `HazelcastOSGiInstance` which is a subtype of `HazelcastInstance` and these instances delegate all calls to the underlying `HazelcastInstance`.

### 23.3. Configuring Hazelcast OSGI Support

`HazelcastOSGiService` uses three configurations:

- **hazelcast.osgi.start:** If this property is enabled (it is disabled by default), when an `HazelcastOSGiService` is activated, a default Hazelcast instance is created automatically.
- **hazelcast.osgi.register.disabled:** If this property is disabled (it is disabled by default), when a Hazelcast instance is created by `HazelcastOSGiService`, the created `HazelcastOSGiInstance` is registered automatically as OSGi service with type of `HazelcastOSGiInstance` and it is deregistered automatically when the created `HazelcastOSGiInstance` is shutdown.
- **hazelcast.osgi.grouping.disabled:** If this property is disabled (it is disabled by default), every created `HazelcastOSGiInstance` is grouped as their owner `HazelcastOSGiService` and do not join each other unless no group name is specified in the `GroupConfig` of `Config`.

## 23.4. Design

`HazelcastOSGiService` is specific to each Hazelcast bundle. This means that every Hazelcast bundle has its own `HazelcastOSGiService` instance.

Every Hazelcast bundle registers its `HazelcastOSGiService` instances via Hazelcast Bundle Activator (`com.hazelcast.osgi.impl.Activator`) while they are being started, and it deregisters its `HazelcastOSGiService` instances while they are being stopped.

Each `HazelcastOSGiService` instance has a different service ID as the combination of Hazelcast version and artifact type (OSS or EE). Examples are `3.6#OSS`, `3.6#EE`, `3.7#OSS`, `3.7#EE`, etc.

`HazelcastOSGiService` instance lifecycle is the same with the owner Hazelcast bundle. This means that when the owner bundle is deactivated, the owned `HazelcastOSGiService` instance is deactivated, and all active Hazelcast instances that are created and served by that `HazelcastOSGiService` instance are also shutdown and deregistered. When the Hazelcast bundle is re-activated, its `HazelcastOSGiService` instance is registered again as the OSGi service.

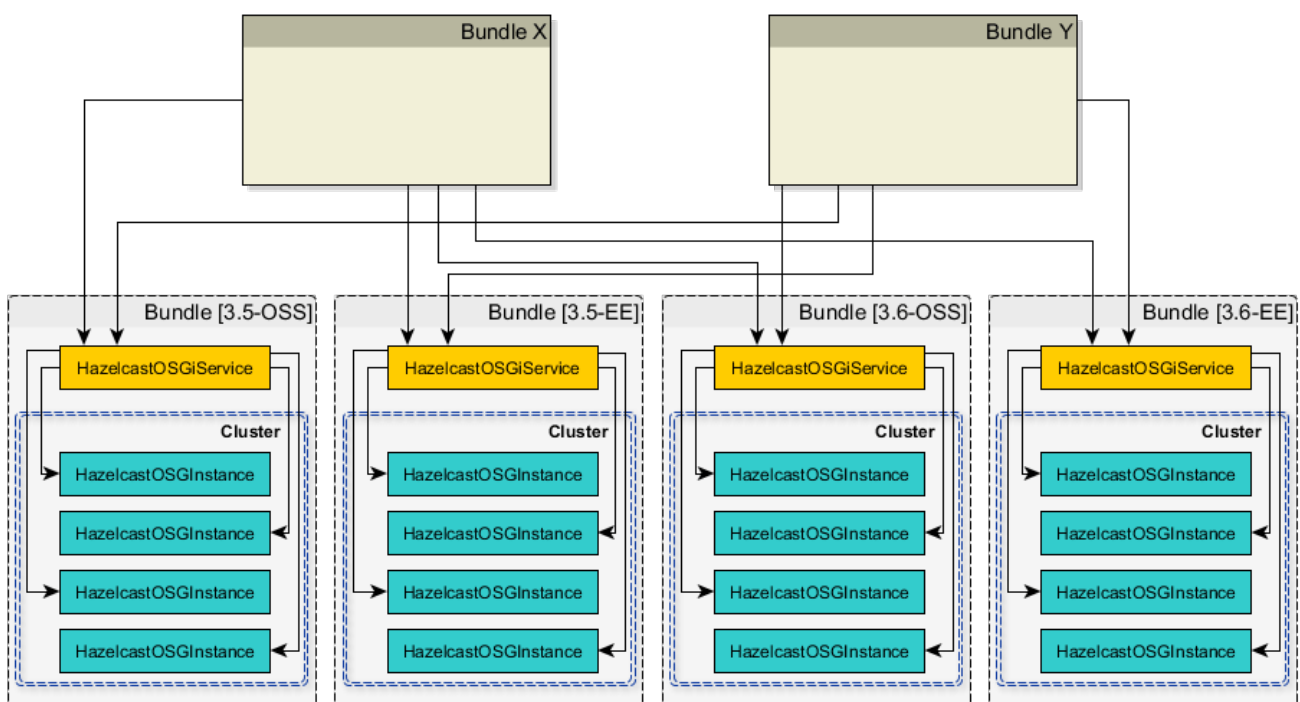

## 23.5. Using Hazelcast OSGI Service

### 23.5.1. Getting Hazelcast OSGI Service Instances

You can access all `HazelcastOSGiService` instances through `org.osgi.framework.BundleContext` for each Hazelcast bundle as follows:

```
for (ServiceReference serviceRef : context.getServiceReferences(HazelcastOSGiService.class.getName(), null)) {
    HazelcastOSGiService service = (HazelcastOSGiService) context.getService(serviceRef);
    String serviceId = service.getId();
    ...
}
```

### 23.5.2. Managing and Using Hazelcast instances

You can use `HazelcastOSGiService` instance to create and shutdown Hazelcast instances on OSGI environments. The created Hazelcast instances are `HazelcastOSGiInstance` typed (which is sub-type of `HazelcastInstance`) and are just proxies to the underlying Hazelcast instance. There are several methods in `HazelcastOSGiService` to use Hazelcast instances on OSGI environments as shown below.

```

// Get the default Hazelcast instance owned by `hazelcastOsgiService`
// Returns null if `HAZELCAST_OSGI_START` is not enabled
HazelcastOSGiInstance defaultInstance = hazelcastOsgiService
.getDefaultHazelcastInstance();

// Creates a new Hazelcast instance with default configurations as owned by
`hazelcastOsgiService`
HazelcastOSGiInstance newInstance1 = hazelcastOsgiService.newHazelcastInstance();

// Creates a new Hazelcast instance with specified configuration as owned by
`hazelcastOsgiService`
Config config = new Config();
config.setInstanceName("OSGI-Instance");
...
HazelcastOSGiInstance newInstance2 = hazelcastOsgiService.newHazelcastInstance(config
);

// Gets the Hazelcast instance with the name `OSGI-Instance`, which is `newInstance2`
created above
HazelcastOSGiInstance instance = hazelcastOsgiService.getHazelcastInstanceByName(
"OSGI-Instance");

// Shuts down the Hazelcast instance with name `OSGI-Instance`, which is
`newInstance2`
hazelcastOsgiService.shutdownHazelcastInstance(instance);

// Print all active Hazelcast instances owned by `hazelcastOsgiService`
for (HazelcastOSGiInstance instance : hazelcastOsgiService.getAllHazelcastInstances())
{
    System.out.println(instance);
}

// Shuts down all Hazelcast instances owned by `hazelcastOsgiService`
hazelcastOsgiService.shutdownAll();

```

## 24. Extending Hazelcast

This chapter describes the different possibilities to extend Hazelcast with additional services or features.

### 24.1. User Defined Services

In the case of special/custom needs, you can use Hazelcast's SPI (Service Provider Interface) module to develop your own distributed data structures and services on top of Hazelcast. Hazelcast SPI is an internal, low-level API which is expected to change in each release except for the patch releases. Your structures and services evolve as the SPI changes.

Throughout this section, we create an example distributed counter that will be the guide to reveal the Hazelcast Services SPI usage.

Here is our counter.

```
public interface Counter{
    int inc(int amount);
}
```

This counter will have the following features: - It will be stored in Hazelcast. - Different cluster members can call it. - It will be scalable, meaning that the capacity for the number of counters scales with the number of cluster members. - It will be highly available, meaning that if a member hosting this counter goes down, a backup will be available on a different member.

All these features are done with the steps below. Each step adds a new functionality to this counter.

1. Create the class.
2. Enable the class.
3. Add properties.
4. Place a remote call.
5. Create the containers.
6. Enable partition migration.
7. Create the backups.

### 24.1.1. Creating the Service Class

To have the counter as a functioning distributed object, we need a class. This class (named `CounterService` in the following example code) is the gateway between Hazelcast internals and the counter, allowing us to add features to the counter. The following example code creates the class `CounterService`. Its lifecycle is managed by Hazelcast.

`CounterService` should implement the interface `com.hazelcast.spi.ManagedService` as shown below. The `com.hazelcast.spi.ManagedService` [source code is here](#).

`CounterService` implements the following methods.

- **init**: This is called when `CounterService` is initialized. `NodeEngine` enables access to Hazelcast internals such as `HazelcastInstance` and `PartitionService`. Also, the object `Properties` will provide us with the ability to create our own properties.
- **shutdown**: This is called when `CounterService` is shutdown. It cleans up the resources.
- **reset**: This is called when cluster members face the split-brain issue. This occurs when disconnected members that have created their own cluster are merged back into the main cluster. Services can also implement the `SplitBrainHandleService` to indicate that they can take part in the merge process. For `CounterService` we are going to implement `reset` as a no-op.

```

public class CounterService implements ManagedService {

    private NodeEngine nodeEngine;

    @Override
    public void init(NodeEngine nodeEngine, Properties properties) {
        System.out.println("CounterService.init()");
        this.nodeEngine = nodeEngine;
    }

    @Override
    public void shutdown(boolean terminate) {
        System.out.println("CounterService.shutdown()");
    }

    @Override
    public void reset() {
    }

    public NodeEngine getNodeEngine() {
        return nodeEngine;
    }
}

```

### 24.1.2. Enabling the Service Class

Now, we need to enable the class `CounterService`. The declarative way of doing this is shown below.

```

<network>
  <join><multicast enabled="true"/> </join>
</network>
<services>
  <service enabled="true">
    <name>CounterService</name>
    <class-name>CounterService</class-name>
  </service>
</services>

```

The `CounterService` is declared within the `services` configuration element.

- Set the `enabled` attribute to `true` to enable the service.
- Set the `name` attribute to the name of the service. It should be a unique name (`CounterService` in our case) since it will be looked up when a remote call is made. Note that the value of this attribute will be sent at each request and a longer `name` value means more data (de)serialization. A good practice is to give an understandable name with the shortest possible length.
- Set the `class-name` attribute to the class name of the service (`CounterService` in our case). The class should have a **no-arg** constructor. Otherwise, the object cannot be initialized.



Note that multicast is enabled as the join mechanism. In the later sections for the `CounterService` example, we will see why.

### 24.1.3. Adding Properties to the Service

The `init` method for `CounterService` takes the `Properties` object as an argument. This means we can add properties to the service that are passed to the `init` method; see [Creating the Service Class](#). You can add properties declaratively as shown below. (You likely want to name your properties something other than `someproperty`.)

```
<service enabled="true">
  <name>CounterService</name>
  <class-name>CounterService</class-name>
  <properties>
    <someproperty>10</someproperty>
  </properties>
</service>
```

If you want to parse a more complex XML, you can use the interface `com.hazelcast.spi.ServiceConfigurationParser`. It gives you access to the XML DOM tree.

### 24.1.4. Starting the Service

Now, let's start a `HazelcastInstance` as shown below, which will start the `CounterService`.

```
public class Member {

    public static void main(String[] args) {
        Hazelcast.newHazelcastInstance();

        Hazelcast.shutdownAll();
    }
}
```

Once it starts, the `CounterService` `init` method prints the following output.

```
CounterService.init
```

Once the `HazelcastInstance` is shutdown (for example, with Ctrl+C), the `CounterService` `shutdown` method prints the following output.

```
CounterService.shutdown
```

### 24.1.5. Placing a Remote Call via Proxy

In the previous sections for the `CounterService` example, we started `CounterService` as part of a `HazelcastInstance` startup.

Now, let's connect the `Counter` interface to `CounterService` and perform a remote call to the cluster

member hosting the counter data. Then, we will return a dummy result.

Remote calls are performed via a proxy in Hazelcast. Proxies expose the methods at the client side. Once a method is called, proxy creates an operation object, sends this object to the cluster member responsible from executing that operation and then sends the result.

### Making Counter a Distributed Object

First, we need to make the `Counter` interface a distributed object by extending the `DistributedObject` interface, as shown below.

```
public interface Counter extends DistributedObject {
    int inc(int amount);
}
```

### Implementing ManagedService and RemoteService

Now, we need to make the `CounterService` class implement not only the `ManagedService` interface, but also the interface `com.hazelcast.spi.RemoteService`. This way, a client will be able to get a handle of a counter proxy. You can check the source code for `RemoteService` the [here](#).

```

public class CounterService implements ManagedService, RemoteService {

    static final String NAME = "CounterService";

    Container[] containers;
    private NodeEngine nodeEngine;

    @Override
    public DistributedObject createDistributedObject(String objectName) {
        return new CounterProxy(objectName, nodeEngine, this);
    }

    @Override
    public void destroyDistributedObject(String objectName) {
        // for the time being a no-op
    }

    @Override
    public void init(NodeEngine nodeEngine, Properties properties) {
        this.nodeEngine = nodeEngine;
    }

    @Override
    public void shutdown(boolean terminate) {
    }

    @Override
    public void reset() {
    }
}

```

The `CounterProxy` returned by the method `createDistributedObject` is a local representation to (potentially) remote managed data and logic.



Note that caching and removing the proxy instance are done outside of this service.

### Implementing CounterProxy

Now, it is time to implement the `CounterProxy` as shown below. `CounterProxy` extends `AbstractDistributedObject`, source code is [here](#).

```

public class CounterProxy extends AbstractDistributedObject<CounterService> implements
Counter {

    private final String name;

    CounterProxy(String name, NodeEngine nodeEngine, CounterService counterService) {
        super(nodeEngine, counterService);
        this.name = name;
    }

    @Override
    public String getServiceName() {
        return CounterService.NAME;
    }

    @Override
    public String getName() {
        return name;
    }

    @Override
    public int inc(int amount) {
        NodeEngine nodeEngine = getNodeEngine();
        IncOperation operation = new IncOperation(name, amount);
        int partitionId = nodeEngine.getPartitionService().getPartitionId(name);
        InvocationBuilder builder = nodeEngine.getOperationService()
            .createInvocationBuilder(CounterService.NAME, operation, partitionId);
        try {
            Future<Integer> future = builder.invoke();
            return future.get();
        } catch (Exception e) {
            throw ExceptionUtil.rethrow(e);
        }
    }
}

```

**CounterProxy** is a local representation of remote data/functionality. It does not include the counter state. Therefore, the method **inc** should be invoked on the cluster member hosting the real counter. You can invoke it using Hazelcast SPI; then it will send the operations to the correct member and return the results.

Let's dig deeper into the method **inc**.

- First, we create **IncOperation** with a given **name** and **amount**.
- Then, we get the partition ID based on the **name**; by this way, all operations for a given name will result in the same partition ID.
- Then, we create an **InvocationBuilder** where the connection between operation and partition is made.

- Finally, we invoke the `InvocationBuilder` and wait for its result. This waiting is performed with a `future.get()`. In our case, timeout is not important. However, it is a good practice to use a timeout for a real system since operations should complete in a certain amount of time.

## Dealing with Exceptions

Hazelcast's `ExceptionUtil` is a good solution when it comes to dealing with execution exceptions. When the execution of the operation fails with an exception, an `ExecutionException` is thrown and handled with the method `ExceptionUtil.rethrow(Throwable)`.

If it is an `InterruptedException`, we have two options: either propagate the exception or just use the `ExceptionUtil.rethrow` for all exceptions. Please see the example code below.

```
try {
    final Future<Integer> future = invocation.invoke();
    return future.get();
} catch(InterruptedException e){
    throw e;
} catch(Exception e){
    throw ExceptionUtil.rethrow(e);
}
```

## Implementing the PartitionAwareOperation Interface

Now, let's write the `IncOperation`. It implements the `PartitionAwareOperation` interface, meaning that it will be executed on the partition that hosts the counter. See the `PartitionAwareOperation` source code [here](#).

The method `run` does the actual execution. Since `IncOperation` will return a response, the method `returnsResponse` returns `true`. If your method is asynchronous and does not need to return a response, it is better to return `false` since it will be faster. The actual response is stored in the field `returnValue`; retrieve it with the method `getResponse`.

There are two more methods in this code: `writeInternal` and `readInternal`. Since `IncOperation` needs to be serialized, these two methods are overridden, and hence, `objectId` and `amount` are serialized and available when those operations are executed.

For the deserialization, note that the operation must have a **no-arg** constructor.

```

class IncOperation extends Operation implements PartitionAwareOperation {

    private String objectId;
    private int amount;
    private int returnValue;

    public IncOperation() {
    }

    IncOperation(String objectId, int amount) {
        this.amount = amount;
        this.objectId = objectId;
    }

    @Override
    public void run() throws Exception {
        System.out.println("Executing " + objectId + ".inc() on: " + getNodeEngine()
            .getThisAddress());
        returnValue = 0;
    }

    @Override
    public Object getResponse() {
        return returnValue;
    }

    @Override
    protected void writeInternal(ObjectDataOutput out) throws IOException {
        super.writeInternal(out);
        out.writeUTF(objectId);
        out.writeInt(amount);
    }

    @Override
    protected void readInternal(ObjectDataInput in) throws IOException {
        super.readInternal(in);
        objectId = in.readUTF();
        amount = in.readInt();
    }
}

```

## Running the Code

Now, let's run our code.

```

HazelcastInstance[] instances = new HazelcastInstance[2];
for (int i = 0; i < instances.length; i++) {
    instances[i] = Hazelcast.newHazelcastInstance();
}

Counter[] counters = new Counter[4];
for (int i = 0; i < counters.length; i++) {
    counters[i] = instances[0].getDistributedObject(CounterService.NAME, i + "counter
");
}

for (Counter counter : counters) {
    System.out.println(counter.inc(1));
}

System.out.println("Finished");
Hazelcast.shutdownAll();

```

Once run, you will see the output as below.

```

Executing 0counter.inc() on: Address[192.168.1.103]:5702
0
Executing 1counter.inc() on: Address[192.168.1.103]:5702
0
Executing 2counter.inc() on: Address[192.168.1.103]:5701
0
Executing 3counter.inc() on: Address[192.168.1.103]:5701
0
Finished

```

Note that counters are stored in different cluster members. Also note that increment is not active for now since the value remains as 0.

Until now, we have performed the basics to get this up and running. In the next section, we will make a real counter, cache the proxy instances and deal with proxy instance destruction.

### 24.1.6. Creating Containers

Let's create a Container for every partition in the system. This container will contain all counters and proxies.

```

class Container {
    private final Map<String, Integer> values = new HashMap();

    int inc(String id, int amount) {
        Integer counter = values.get(id);
        if (counter == null) {
            counter = 0;
        }
        counter += amount;
        values.put(id, counter);
        return counter;
    }

    public void init(String objectName) {
        values.put(objectName, 0);
    }

    public void destroy(String objectName) {
        values.remove(objectName);
    }
}

```

Hazelcast guarantees that a single thread will be active in a single partition. Therefore, when accessing a container, concurrency control will not be an issue.

The code in our example uses a `Container` instance per partition approach. With this approach, there will not be any mutable shared state between partitions. This approach also makes operations on partitions simpler since you do not need to filter out data that does not belong to a certain partition.

The code performs the tasks below.

- It creates a container for every partition with the method `init`.
- It creates the proxy with the method `createDistributedObject`.
- It removes the value of the object with the method `destroyDistributedObject`, otherwise we may get an `OutOfMemory` exception.

### Integrating the Container in the CounterService

Let's integrate the `Container` in the `CounterService`, as shown below.



```

public class CounterService implements ManagedService, RemoteService {
    public final static String NAME = "CounterService";
    Container[] containers;
    private NodeEngine nodeEngine;

    @Override
    public void init(NodeEngine nodeEngine, Properties properties) {
        this.nodeEngine = nodeEngine;
        containers = new Container[nodeEngine.getPartitionService().getPartitionCount
()];
        for (int k = 0; k < containers.length; k++)
            containers[k] = new Container();
    }

    @Override
    public void shutdown(boolean terminate) {
    }

    @Override
    public CounterProxy createDistributedObject(String objectName) {
        int partitionId = nodeEngine.getPartitionService().getPartitionId(objectName);
        Container container = containers[partitionId];
        container.init(objectName);
        return new CounterProxy(objectName, nodeEngine, this);
    }

    @Override
    public void destroyDistributedObject(String objectName) {
        int partitionId = nodeEngine.getPartitionService().getPartitionId(objectName);
        Container container = containers[partitionId];
        container.destroy(objectName);
    }

    @Override
    public void reset() {
    }

    public static class Container {
        final Map<String, Integer> values = new HashMap<String, Integer>();

        private void init(String objectName) {
            values.put(objectName, 0);
        }

        private void destroy(String objectName){
            values.remove(objectName);
        }
    }
}

```

## Connecting the `IncOperation.run` Method to the Container

As the last step in creating a Container, we connect the method `IncOperation.run` to the Container, as shown below.

`partitionId` has a range between `0` and `partitionCount` and can be used as an index for the container array. Therefore, you can use `partitionId` to retrieve the container and once the container has been retrieved, you can access the value.

```

class IncOperation extends Operation implements PartitionAwareOperation {
    private String objectId;
    private int amount, returnValue;

    public IncOperation() {
    }

    public IncOperation(String objectId, int amount) {
        this.amount = amount;
        this.objectId = objectId;
    }

    @Override
    public void run() throws Exception {
        System.out.println("Executing " + objectId + ".inc() on: " + getNodeEngine()
.getThisAddress());
        CounterService service = getService();
        CounterService.Container container = service.containers[getPartitionId()];
        Map<String, Integer> valuesMap = container.values;

        Integer counter = valuesMap.get(objectId);
        counter += amount;
        valuesMap.put(objectId, counter);
        returnValue = counter;
    }

    @Override
    public Object getResponse() {
        return returnValue;
    }

    @Override
    protected void writeInternal(ObjectDataOutput out) throws IOException {
        super.writeInternal(out);
        out.writeUTF(objectId);
        out.writeInt(amount);
    }

    @Override
    protected void readInternal(ObjectDataInput in) throws IOException {
        super.readInternal(in);
        objectId = in.readUTF();
        amount = in.readInt();
    }
}

```

## Running the Sample Code

Let's run the following sample code.

```

public class Member {
    public static void main(String[] args) {
        HazelcastInstance[] instances = new HazelcastInstance[2];
        for (int k = 0; k < instances.length; k++)
            instances[k] = Hazelcast.newHazelcastInstance();

        Counter[] counters = new Counter[4];
        for (int k = 0; k < counters.length; k++)
            counters[k] = instances[0].getDistributedObject(CounterService.NAME, k+
"counter");

        System.out.println("Round 1");
        for (Counter counter: counters)
            System.out.println(counter.inc(1));

        System.out.println("Round 2");
        for (Counter counter: counters)
            System.out.println(counter.inc(1));

        System.out.println("Finished");
        System.exit(0);
    }
}

```

The output will be as follows. It indicates that we have now a basic distributed counter up and running.

```

Round 1
Executing 0counter.inc() on: Address[192.168.1.103]:5702
1
Executing 1counter.inc() on: Address[192.168.1.103]:5702
1
Executing 2counter.inc() on: Address[192.168.1.103]:5701
1
Executing 3counter.inc() on: Address[192.168.1.103]:5701
1
Round 2
Executing 0counter.inc() on: Address[192.168.1.103]:5702
2
Executing 1counter.inc() on: Address[192.168.1.103]:5702
2
Executing 2counter.inc() on: Address[192.168.1.103]:5701
2
Executing 3counter.inc() on: Address[192.168.1.103]:5701
2
Finished

```

## 24.1.7. Partition Migration

In the previous section, we created a real distributed counter. Now, we need to make sure that the content of the partition containers is migrated to different cluster members when a member joins or leaves the cluster. To make this happen, first we need to add three new methods (`applyMigrationData`, `toMigrationData` and `clear`) to the `Container`.

- `toMigrationData`: This method is called when Hazelcast wants to start the partition migration from the member owning the partition. The result of the `toMigrationData` method is the partition data in a form that can be serialized to another member.
- `applyMigrationData`: This method is called when `migrationData` (created by the method `toMigrationData`) will be applied to the member that will be the new partition owner.
- `clear`: This method is called when the partition migration is successfully completed and the old partition owner gets rid of all data in the partition. This method is also called when the partition migration operation fails and the to-be-the-new partition owner needs to roll back its changes.

```

class Container {
    private final Map<String, Integer> values = new HashMap();

    int inc(String id, int amount) {
        Integer counter = values.get(id);
        if (counter == null) {
            counter = 0;
        }
        counter += amount;
        values.put(id, counter);
        return counter;
    }

    void clear() {
        values.clear();
    }

    void applyMigrationData(Map<String, Integer> migrationData) {
        values.putAll(migrationData);
    }

    Map<String, Integer> toMigrationData() {
        return new HashMap(values);
    }

    public void init(String objectName) {
        values.put(objectName, 0);
    }

    public void destroy(String objectName) {
        values.remove(objectName);
    }
}

```

### Transferring migrationData

After you add these three methods to the `Container`, you need to create a `CounterMigrationOperation` class that transfers `migrationData` from one member to another and calls the method `applyMigrationData` on the correct partition of the new partition owner.

An example is shown below.

```

public class CounterMigrationOperation extends Operation {

    Map<String, Integer> migrationData;

    public CounterMigrationOperation() {
    }

    public CounterMigrationOperation(Map<String, Integer> migrationData) {
        this.migrationData = migrationData;
    }

    @Override
    public void run() throws Exception {
        CounterService service = getService();
        Container container = service.containers[getPartitionId()];
        container.applyMigrationData(migrationData);
    }

    @Override
    protected void writeInternal(ObjectDataOutput out) throws IOException {
        out.writeInt(migrationData.size());
        for (Map.Entry<String, Integer> entry : migrationData.entrySet()) {
            out.writeUTF(entry.getKey());
            out.writeInt(entry.getValue());
        }
    }

    @Override
    protected void readInternal(ObjectDataInput in) throws IOException {
        int size = in.readInt();
        migrationData = new HashMap<String, Integer>();
        for (int i = 0; i < size; i++)
            migrationData.put(in.readUTF(), in.readInt());
    }
}

```



During a partition migration, no other operations are executed on the related partition.

### Letting Hazelcast Know CounterService Can Do Partition Migrations

We need to make our `CounterService` class implement the `MigrationAwareService` interface. This will let Hazelcast know that the `CounterService` can perform partition migration.

With the `MigrationAwareService` interface, some additional methods are exposed. For example, the method `prepareMigrationOperation` returns all the data of the partition that is going to be moved. You can check the `MigrationAwareService` source code [here](#).

The method `commitMigration` commits the data, meaning that in this case, it clears the partition

container of the old owner.

```
public class CounterService implements ManagedService, RemoteService,
MigrationAwareService {
    public final static String NAME = "CounterService";
    Container[] containers;
    private NodeEngine nodeEngine;

    @Override
    public void init(NodeEngine nodeEngine, Properties properties) {
        this.nodeEngine = nodeEngine;
        containers = new Container[nodeEngine.getPartitionService().getPartitionCount
()];
        for (int k = 0; k < containers.length; k++)
            containers[k] = new Container();
    }

    @Override
    public void shutdown(boolean terminate) {
    }

    @Override
    public DistributedObject createDistributedObject(String objectName) {
        int partitionId = nodeEngine.getPartitionService().getPartitionId(objectName);
        Container container = containers[partitionId];
        container.init(objectName);
        return new CounterProxy(objectName, nodeEngine, this);
    }

    @Override
    public void destroyDistributedObject(String objectName) {
        int partitionId = nodeEngine.getPartitionService().getPartitionId(objectName);
        Container container = containers[partitionId];
        container.destroy(objectName);
    }

    @Override
    public void beforeMigration(PartitionMigrationEvent e) {
        //no-op
    }

    @Override
    public void clearPartitionReplica(int partitionId) {
        Container container = containers[partitionId];
        container.clear();
    }

    @Override
    public Operation prepareReplicationOperation(PartitionReplicationEvent e) {
        if (e.getReplicaIndex() > 1) {

```



```

        return null;
    }
    Container container = containers[e.getPartitionId()];
    Map<String, Integer> data = container.toMigrationData();
    return data.isEmpty() ? null : new CounterMigrationOperation(data);
}

@Override
public void commitMigration(PartitionMigrationEvent e) {
    if (e.getMigrationEndpoint() == MigrationEndpoint.SOURCE) {
        Container c = containers[e.getPartitionId()];
        c.clear();
    }

    //todo
}

@Override
public void rollbackMigration(PartitionMigrationEvent e) {
    if (e.getMigrationEndpoint() == MigrationEndpoint.DESTINATION) {
        Container c = containers[e.getPartitionId()];
        c.clear();
    }
}

@Override
public void reset() {
}
}

```

## Running the Sample Code

We can run the following code.

```

public class Member {
    public static void main(String[] args) throws Exception {
        HazelcastInstance[] instances = new HazelcastInstance[3];
        for (int k = 0; k < instances.length; k++)
            instances[k] = Hazelcast.newHazelcastInstance();

        Counter[] counters = new Counter[4];
        for (int k = 0; k < counters.length; k++)
            counters[k] = instances[0].getDistributedObject(CounterService.NAME, k +
"counter");

        for (Counter counter : counters)
            System.out.println(counter.inc(1));

        Thread.sleep(10000);

        System.out.println("Creating new members");

        for (int k = 0; k < 3; k++) {
            Hazelcast.newHazelcastInstance();
        }

        Thread.sleep(10000);

        for (Counter counter : counters)
            System.out.println(counter.inc(1));

        System.out.println("Finished");
        System.exit(0);
    }
}

```

And we get the following output.

```

Executing 0counter.inc() on: Address[192.168.1.103]:5702
Executing backup 0counter.inc() on: Address[192.168.1.103]:5703
1
Executing 1counter.inc() on: Address[192.168.1.103]:5703
Executing backup 1counter.inc() on: Address[192.168.1.103]:5701
1
Executing 2counter.inc() on: Address[192.168.1.103]:5701
Executing backup 2counter.inc() on: Address[192.168.1.103]:5703
1
Executing 3counter.inc() on: Address[192.168.1.103]:5701
Executing backup 3counter.inc() on: Address[192.168.1.103]:5703
1
Creating new members
Executing 0counter.inc() on: Address[192.168.1.103]:5705
Executing backup 0counter.inc() on: Address[192.168.1.103]:5703
2
Executing 1counter.inc() on: Address[192.168.1.103]:5703
Executing backup 1counter.inc() on: Address[192.168.1.103]:5704
2
Executing 2counter.inc() on: Address[192.168.1.103]:5705
Executing backup 2counter.inc() on: Address[192.168.1.103]:5704
2
Executing 3counter.inc() on: Address[192.168.1.103]:5704
Executing backup 3counter.inc() on: Address[192.168.1.103]:5705
2
Finished

```

You can see that the counters have moved. `0counter` moved from `192.168.1.103:5702` to `192.168.1.103:5705` and it is incremented correctly. Our counters can now move around in the cluster. You will see the counters will be redistributed once you add or remove a cluster member.

### 24.1.8. Creating Backups

Finally, we make sure that the counter data is available on another member when a member goes down. To do this, have the `IncOperation` class implement the `BackupAwareOperation` interface contained in the SPI package. See the following code.

```

class IncOperation extends Operation
    implements PartitionAwareOperation, BackupAwareOperation {
    ...

    @Override
    public int getAsyncBackupCount() {
        return 0;
    }

    @Override
    public int getSyncBackupCount() {
        return 1;
    }

    @Override
    public boolean shouldBackup() {
        return true;
    }

    @Override
    public Operation getBackupOperation() {
        return new IncBackupOperation(objectId, amount);
    }
}

```

The methods `getAsyncBackupCount` and `getSyncBackupCount` specify the count for asynchronous and synchronous backups. Our sample has one synchronous backup and no asynchronous backups. In the above code, counts of the backups are hard-coded, but they can also be passed to `IncOperation` as parameters.

The method `shouldBackup` specifies whether our `Operation` needs a backup or not. For our sample, it returns `true`, meaning the `Operation` will always have a backup even if there are no changes. Of course, in real systems, we want to have backups if there is a change. For `IncOperation` for example, having a backup when `amount` is null would be a good practice.

The method `getBackupOperation` returns the operation (`IncBackupOperation`) that actually performs the backup creation; the backup itself is an operation and will run on the same infrastructure.

If a backup should be made and `getSyncBackupCount` returns `3`, then three `IncBackupOperation` instances are created and sent to the three machines containing the backup partition. If fewer machines are available, then backups need to be created. Hazelcast will just send a smaller number of operations.

### Performing the Backup with `IncBackupOperation`

Now, let's have a look at the `IncBackupOperation`. It implements `BackupOperation`, you can see the source code for `BackupOperation` [here](#).

```

public class IncBackupOperation
    extends Operation implements BackupOperation {
    private String objectId;
    private int amount;

    public IncBackupOperation() {
    }

    public IncBackupOperation(String objectId, int amount) {
        this.amount = amount;
        this.objectId = objectId;
    }

    @Override
    protected void writeInternal(ObjectDataOutput out) throws IOException {
        super.writeInternal(out);
        out.writeUTF(objectId);
        out.writeInt(amount);
    }

    @Override
    protected void readInternal(ObjectDataInput in) throws IOException {
        super.readInternal(in);
        objectId = in.readUTF();
        amount = in.readInt();
    }

    @Override
    public void run() throws Exception {
        CounterService service = getService();
        System.out.println("Executing backup " + objectId + ".inc() on: "
            + getNodeEngine().getThisAddress());
        Container c = service.containers[getPartitionId()];
        c.inc(objectId, amount);
    }
}

```



Hazelcast will also make sure that a new IncOperation for that particular key will not be executed before the (synchronous) backup operation has completed.

## Running the Sample Code

Let's see the backup functionality in action with the following code.

```

public class Member {
    public static void main(String[] args) throws Exception {
        HazelcastInstance[] instances = new HazelcastInstance[2];
        for (int k = 0; k < instances.length; k++)
            instances[k] = Hazelcast.newHazelcastInstance();

        Counter counter = instances[0].getDistributedObject(CounterService.NAME,
"counter");
        counter.inc(1);
        System.out.println("Finished");
        System.exit(0);
    }
}

```

Once it is run, the following output will be seen.

```

Executing counter0.inc() on: Address[192.168.1.103]:5702
Executing backup counter0.inc() on: Address[192.168.1.103]:5701
Finished

```

As it can be seen, both `IncOperation` and `IncBackupOperation` are executed. Notice that these operations have been executed on different cluster members to guarantee high availability.

## 24.2. OperationParker

`OperationParker` is an interface offered by SPI for the objects, such as Lock and Semaphore, to be used when a thread needs to wait for a lock to be released. You can see the `OperationParker` source code [here](#).

`OperationParker` keeps a list of waiters. For each notify operation:

- it looks for a waiter,
- it asks the waiter whether it wants to keep waiting,
- if the waiter responds **no**, the service executes its registered operation (operation itself knows where to send a response),
- it rinses and repeats until a waiter wants to keep waiting.

Each waiter can sit on a wait-notify queue for, at most, its operation's call timeout. For example, by default, each waiter can wait here for at most 1 minute. A continuous task scans expired/timed-out waiters and invalidates them with `CallTimeoutException`. Each waiter on the remote side should retry and keep waiting if it still wants to wait. This is a liveness check for remote waiters.

This way, it is possible to distinguish an unresponsive member and a long (~infinite) wait. On the caller side, if the waiting thread does not get a response for either a call timeout or for more than **2 times the call-timeout**, it will exit with `OperationTimeoutException`.

Note that this behavior breaks the fairness. Hazelcast does not support fairness for any of the data structures with blocking operations, such as Lock and Semaphore.

## 24.3. Discovery SPI

By default, Hazelcast is bundled with multiple ways to define and find other members in the same network. Commonly used, especially with development, is the Multicast discovery. This sends out a multicast request to a network segment and awaits other members to answer with their IP addresses. In addition, Hazelcast supports fixed IP addresses: [jclouds®](#) or [AWS \(Amazon EC2\)](#) based discoveries.

Since there is an ever growing number of public and private cloud environments, as well as numerous Service Discovery systems in the wild, Hazelcast provides cloud or service discovery vendors with the option to implement their own discovery strategy.

Over the course of this section, we will build a simple discovery strategy based on the `/etc/hosts` file.

### 24.3.1. Discovery SPI Interfaces and Classes

The Hazelcast Discovery SPI (Member Discovery Extensions) consists of multiple interfaces and abstract classes. In the following subsections, we will have a quick look at all of them and shortly introduce the idea and usage behind them. The example will follow in the next section, [Discovery Strategy](#).

#### **DiscoveryStrategy: Implement**

The `com.hazelcast.spi.discovery.DiscoveryStrategy` interface is the main entry point for vendors to implement their corresponding member discovery strategies. Its main purpose is to return discovered members on request. The `com.hazelcast.spi.discovery.DiscoveryStrategy` interface also offers light lifecycle capabilities for setup and teardown logic (for example, opening or closing sockets or REST API clients).

`DiscoveryStrategy`'s can also do automatic registration / de-registration on service discovery systems if necessary. You can use the provided `DiscoveryNode` that is passed to the factory method to retrieve local addresses and ports, as well as metadata.

#### **AbstractDiscoveryStrategy: Abstract Class**

The `com.hazelcast.spi.discovery.AbstractDiscoveryStrategy` is a convenience abstract class meant to ease the implementation of strategies. It basically provides additional support for reading / resolving configuration properties and empty implementations of lifecycle methods if unnecessary.

#### **DiscoveryStrategyFactory: Factory Contract**

The `com.hazelcast.spi.discovery.DiscoveryStrategyFactory` interface describes the factory contract that creates a certain `DiscoveryStrategy`. `DiscoveryStrategyFactory` s are registered automatically at startup of a Hazelcast member or client whenever they are found in the classpath. For automatic discovery, factories need to announce themselves as SPI services using a resource file according to

the [Java Service Provider Interface](#). The service registration file must be part of the JAR file, located under `META-INF/services/com.hazelcast.spi.discovery.DiscoveryStrategyFactory`, and consist of a line with the full canonical class name of the `DiscoveryStrategy` per provided strategy implementation.

### **DiscoveryNode: Describe a Member**

The `com.hazelcast.spi.discovery.DiscoveryNode` abstract class describes a member in the Discovery SPI. It is used for multiple purposes, since it will be returned from strategies for discovered members. It is also passed to `DiscoveryStrategyFactory`'s` factory method to define the local member itself if created on a Hazelcast member; on Hazelcast clients, null will be passed.

### **SimpleDiscoveryNode: Default DiscoveryNode**

`com.hazelcast.spi.discovery.SimpleDiscoveryNode` is a default implementation of the `DiscoveryNode`. It is meant for convenience use of the Discovery SPI and can be returned from vendor implementations if no special needs are required.

### **NodeFilter: Filter Members**

You can configure `com.hazelcast.spi.discovery.NodeFilter` before startup and you can implement logic to do additional filtering of members. This might be necessary if query languages for discovery strategies are not expressive enough to describe members or to overcome inefficiencies of strategy implementations.



The `DiscoveryStrategy` vendor does not need to take possibly configured filters into account as their use is transparent to the strategies.

### **DiscoveryService: Support In Integrator Systems**

A `com.hazelcast.spi.discovery.integration.DiscoveryService` is part of the integration domain. `DiscoveryStrategy` vendors do not need to implement `DiscoveryService` because it is meant to support the Discovery SPI in situations where vendors integrate Hazelcast into their own systems or frameworks. Certain needs might be necessary as part of the classloading or [Java Service Provider Interface](#) lookup.

### **DiscoveryServiceProvider: Provide a DiscoveryService**

Use the `com.hazelcast.spi.discovery.integration.DiscoveryServiceProvider` to provide a `DiscoveryService` to the Hazelcast discovery subsystem. Configure the provider with the Hazelcast configuration API.

### **DiscoveryServiceSettings: Configure DiscoveryService**

A `com.hazelcast.spi.discovery.integration.DiscoveryServiceSettings` instance is passed to the `DiscoveryServiceProvider` at creation time to configure the `DiscoveryService`.

### **DiscoveryMode: Member or Client**

The `com.hazelcast.spi.discovery.integration.DiscoveryMode` enum tells if a created



`DiscoveryService` is running on a Hazelcast member or client to change the behavior accordingly.

### 24.3.2. Discovery Strategy

This subsection will walk through the implementation of a simple `DiscoveryStrategy` and their necessary setup.

#### Discovery Strategy Example

The example strategy will use the local `/etc/hosts` (and on Windows it will use the equivalent to the `\*nix` hosts file named `%SystemRoot%\system32\drivers\etc\hosts`) to lookup IP addresses of different hosts. The strategy implementation expects hosts to be configured with hostname sub-groups under the same domain. So far to theory, let's get into it.

The full example's source code can be found in the [Hazelcast examples repository](#).

#### Configuring Site Domain

As a first step we do some basic configuration setup. We want the user to be able to configure the site domain for the discovery inside the hosts file, therefore we define a configuration property called `site-domain`. The configuration is not optional: it must be configured before the creation of the `HazelcastInstance`, either via XML or the Hazelcast Config API.

It is recommended that you keep all defined properties in a separate configuration class as public constants (public final static) with sufficient documentation. This allows users to easily look up possible configuration values.

```
public final class HostsDiscoveryConfiguration {  
  
    public static final PropertyDefinition DOMAIN = new SimplePropertyDefinition(  
        "site-domain", PropertyTypeConverter.STRING);  
  
    private HostsDiscoveryConfiguration() {  
    }  
}
```

An additional `ValueValidator` could be passed to the definition to make sure the configured value looks like a domain or has a special format.

#### Creating Discovery

As the second step we create the very simple `DiscoveryStrategyFactory` implementation class. To keep things clear we are going to name the discovery strategy after its purpose: looking into the hosts file.

```

public class HostsDiscoveryStrategyFactory implements DiscoveryStrategyFactory {

    private static final Collection<PropertyDefinition> PROPERTIES = singletonList
(HostsDiscoveryConfiguration.DOMAIN);

    @Override
    public Class<? extends DiscoveryStrategy> getDiscoveryStrategyType() {
        return HostsDiscoveryStrategy.class;
    }

    @Override
    public DiscoveryStrategy newDiscoveryStrategy(DiscoveryNode discoveryNode, ILogger
logger, Map<String, Comparable> properties) {
        return new HostsDiscoveryStrategy(logger, properties);
    }

    @Override
    public Collection<PropertyDefinition> getConfigurationProperties() {
        return PROPERTIES;
    }
}

```

This factory now defines properties known to the discovery strategy implementation and provides a clean way to instantiate it. While creating the `HostsDiscoveryStrategy` we ignore the passed `DiscoveryNode` since this strategy will not support automatic registration of new members. In cases where the strategy does not support registration, the environment has to handle this in some provided way.



Remember that, when created on a Hazelcast client, the provided `DiscoveryNode` will be null, as there is no local member in existence.

Next, we register the `DiscoveryStrategyFactory` to make Hazelcast pick it up automatically at startup. As described earlier, this is done according to the [Java Service Provider Interface](#) specification. The filename is the name of the interface itself. Therefore we create a new resource file called `com.hazelcast.spi.discovery.DiscoveryStrategyFactory` and place it under `META-INF/services`. The content is the full canonical class name of our factory implementation.

```
com.hazelcast.examples.spi.discovery.HostsDiscoveryStrategyFactory
```

If our JAR file will contain multiple factories, each consecutive line can define another full canonical `DiscoveryStrategyFactory` implementation class name.

## Implementing Discovery Strategy

Now comes the interesting part. We are going to implement the discovery itself. The previous parts we did are normally pretty similar for all strategies aside from the configuration properties itself. However, implementing the discovery heavily depends on the way the strategy has to come up with

IP addresses of other Hazelcast members.

### Extending The `AbstractDiscoveryStrategy`

For ease of implementation, we will back our implementation by extending the `AbstractDiscoveryStrategy` and only implementing the absolute minimum ourselves.

```
public class HostsDiscoveryStrategy extends AbstractDiscoveryStrategy {

    private static final String HOSTS_NIX = "/etc/hosts";
    private static final String HOSTS_WINDOWS = "%SystemRoot%\system32\drivers\
etc\hosts";

    private final String siteDomain;

    HostsDiscoveryStrategy(ILogger logger, Map<String, Comparable> properties) {
        super(logger, properties);

        this.siteDomain = getOrNull("discovery.hosts", HostsDiscoveryConfiguration
.DOMAIN);
    }

    @Override
    public Iterable<DiscoveryNode> discoverNodes() {
        List<String> assignments = filterHosts();
        return mapToDiscoveryNodes(assignments);
    }

    private List<String> filterHosts() {
        String os = System.getProperty("os.name");

        String hostsPath;
        if (os.contains("Windows")) {
            hostsPath = HOSTS_WINDOWS;
        } else {
            hostsPath = HOSTS_NIX;
        }

        File hosts = new File(hostsPath);

        List<String> lines = readLines(hosts);

        List<String> assignments = new ArrayList<String>();
        for (String line : lines) {

            if (matchesDomain(line)) {
                assignments.add(line);
            }
        }
    }
}
```

```

    return assignments;
}

private Iterable<DiscoveryNode> mapToDiscoveryNodes(List<String> assignments) {
    Collection<DiscoveryNode> discoveredNodes = new ArrayList<DiscoveryNode>();

    for (String assignment : assignments) {
        String address = sliceAddress(assignment);
        String hostname = sliceHostname(assignment);

        Map<String, Object> attributes = Collections.<String, Object>singletonMap
("hostname", hostname);

        InetAddress inetAddress = mapToInetAddress(address);
        Address addr = new Address(inetAddress, NetworkConfig.DEFAULT_PORT);

        discoveredNodes.add(new SimpleDiscoveryNode(addr, attributes));
    }
    return discoveredNodes;
}

private List<String> readLines(File hosts) {
    try {
        List<String> lines = new ArrayList<String>();
        BufferedReader reader = new BufferedReader(new FileReader(hosts));

        String line;
        while ((line = reader.readLine()) != null) {
            line = line.trim();
            if (!line.startsWith("#")) {
                lines.add(line.trim());
            }
        }

        return lines;
    } catch (IOException e) {
        throw new RuntimeException("Could not read hosts file", e);
    }
}

private boolean matchesDomain(String line) {
    if (line.isEmpty()) {
        return false;
    }
    String hostname = sliceHostname(line);
    return hostname.endsWith(".") + siteDomain);
}

private String sliceAddress(String assignment) {
    String[] tokens = assignment.split("\\p{javaSpaceChar}+");
    if (tokens.length < 1) {

```

```

        throw new RuntimeException("Could not find ip address in " + assignment);
    }
    return tokens[0];
}

private static String sliceHostname(String assignment) {
    String[] tokens = assignment.split("\\p{javaSpaceChar}+|\\t+");
    if (tokens.length < 2) {
        throw new RuntimeException("Could not find hostname in " + assignment);
    }
    return tokens[1];
}

private InetAddress mapToInetAddress(String address) {
    try {
        return InetAddress.getByName(address);
    } catch (UnknownHostException e) {
        throw new RuntimeException("Could not resolve ip address", e);
    }
}
}

```

## Overriding Discovery Configuration

So far our implementation will retrieve the configuration property for the `site-domain`. Our implementation offers the option to override the value from the configuration (XML or Config API) right from the system environment or JVM properties. That can be useful when the `hazelcast.xml` defines a setup for an developer system (like `cluster.local`) and operations wants to override it for the real deployment. By providing a prefix (in this case `discovery.hosts`) we created an external property named `discovery.hosts.site-domain` which can be set as an environment variable or passed as a JVM property from the startup script.

The lookup priority is explained in the following list, priority is from top to bottom:

- JVM properties (or `hazelcast.xml` `<properties/>` section)
- System environment
- Configuration properties

## Implementing Lookup

Since we now have the value for our property we can implement the actual lookup and mapping as already prepared in the `discoverNodes` method. The following part is very specific to this special discovery strategy, for completeness we're showing it anyways.

```

private static final String HOSTS_NIX = "/etc/hosts";
private static final String HOSTS_WINDOWS =
    "%SystemRoot%\system32\drivers\etc\hosts";

private List<String> filterHosts() {
    String os = System.getProperty( "os.name" );

    String hostsPath;
    if ( os.contains( "Windows" ) ) {
        hostsPath = HOSTS_WINDOWS;
    } else {
        hostsPath = HOSTS_NIX;
    }

    File hosts = new File( hostsPath );

    // Read all lines
    List<String> lines = readLines( hosts );

    List<String> assignments = new ArrayList<String>();
    for ( String line : lines ) {
        // Example:
        // 192.168.0.1  host1.cluster.local
        if ( matchesDomain( line ) ) {
            assignments.add( line );
        }
    }
    return assignments;
}

```

### Mapping to `DiscoveryNode`s

After we now collected the address assignments configured in the hosts file we can go to the final step and map those to the `DiscoveryNode`s to return them from our strategy.

```

private Iterable<DiscoveryNode> mapToDiscoveryNodes( List<String> assignments ) {
    Collection<DiscoveryNode> discoveredNodes = new ArrayList<DiscoveryNode>();

    for ( String assignment : assignments ) {
        String address = sliceAddress( assignment );
        String hostname = sliceHostname( assignment );

        Map<String, Object> attributes =
            Collections.singletonMap( "hostname", hostname );

        InetAddress inetAddress = mapToInetAddress( address );
        Address addr = new Address( inetAddress, NetworkConfig.DEFAULT_PORT );

        discoveredNodes.add( new SimpleDiscoveryNode( addr, attributes ) );
    }
    return discoveredNodes;
}

```

With that mapping we now have a full discovery, executed whenever Hazelcast asks for IPs. So why don't we read them in once and cache them? The answer is simple, it might happen that members go down or come up over time. Since we expect the hosts file to be injected into the running container it also might change over time. We want to get the latest available members, therefore we read the file on request.

### Configuring `DiscoveryStrategy`

To actually use the new `DiscoveryStrategy` implementation we need to configure it like in the following example:

```

<hazelcast>
  <!-- activate Discovery SPI -->
  <properties>
    <property name="hazelcast.discovery.enabled">true</property>
  </properties>

  <network>
    <join>
      <!-- deactivating other discoveries -->
      <multicast enabled="false"/>
      <tcp-ip enabled="false" />
      <aws enabled="false"/>

      <!-- activate our discovery strategy -->
      <discovery-strategies>

        <!-- class equals to the DiscoveryStrategy not the factory! -->
        <discovery-strategy enabled="true"
          class="com.hazelcast.examples.spi.discovery.HostsDiscoveryStrategy">

          <properties>
            <property name="site-domain">cluster.local</property>
          </properties>
        </discovery-strategy>
      </discovery-strategies>
    </join>
  </network>
</hazelcast>

```

To find out further details, please have a look at the Discovery SPI Javadoc.

### 24.3.3. DiscoveryService (Framework integration)

Since the `DiscoveryStrategy` is meant for cloud vendors or implementors of service discovery systems, the `DiscoveryService` is meant for integrators. In this case, integrators means people integrating Hazelcast into their own systems or frameworks. In those situations, there are sometimes special requirements on how to lookup framework services like the discovery strategies or similar services. Integrators can extend or implement their own `DiscoveryService` and `DiscoveryServiceProvider` and inject it using the Hazelcast Config API (`com.hazelcast.config.DiscoveryConfig`) prior to instantiating the `HazelcastInstance`. In any case, integrators might have to remember that a `DiscoveryService` might have to change behavior based on the runtime environment (Hazelcast member or client) and then the `DiscoveryServiceSettings` should provide information about the started `HazelcastInstance`.

Since the implementation heavily depends on one's needs, there is no reason to provide an example of how to implement your own `DiscoveryService`. However, Hazelcast provides a default implementation which can be a good example to get started. This default implementation is `com.hazelcast.spi.discovery.impl.DefaultDiscoveryService`.



## 24.4. Config Properties SPI

The Config Properties SPI is an easy way that you can configure SPI plugins using a prebuilt system of automatic conversion and validation.

### 24.4.1. Config Properties SPI Classes

The Config Properties SPI consists of a small set of classes and provided implementations.

#### PropertyDefinition: Define a Single Property

The `com.hazelcast.config.properties.PropertyDefinition` interface defines a single property inside a given configuration. It consists of a key string and type (in form of a `com.hazelcast.core.TypeConverter`).

You can mark properties as optional and you can have an additional validation step to make sure the provided value matches certain rules (like port numbers must be between 0-65535 or similar).

#### SimplePropertyDefinition: Basic PropertyDefinition

For convenience, the `com.hazelcast.config.properties.SimplePropertyDefinition` class is provided. This class is a basic implementation of the `PropertyDefinition` interface and should be enough for most situations. In case of additional needs, you are free to provide your own implementation of the `PropertyDefinition` interface.

#### PropertyTypeConverter: Set of TypeConverters

The `com.hazelcast.config.properties.PropertyTypeConverter` enum provides a preset of `TypeConverter`s`. Provided are the most common basic types:

- String
- Short
- Integer
- Long
- Float
- Double
- Boolean

#### ValueValidator and ValidationException

The `com.hazelcast.config.properties.ValueValidator` interface implements additional value validation. The configured value will be validated before it is returned to the requester. If validation fails, a `com.hazelcast.config.properties.ValidationException` is thrown and the requester has to handle it or throw the exception further.

## 24.4.2. Config Properties SPI Example

This sub-section will show a quick example of how to setup, configure and use the Config Properties SPI.

### Defining a Config PropertyDefinition

Defining a property is as easy as giving it a name and a type.

```
PropertyDefinition property = new SimplePropertyDefinition(
    "my-key", PropertyTypeConverter.STRING
);
```

We defined a property named `my-key` with a type of a string. If none of the predefined `TypeConverter``s matches the need, users are free to provide their own implementation.

### Providing a value in XML

The above property is now configurable in two ways:

```
<!-- option 1 -->
<my-key>value</my-key>

<!-- option 2 -->
<property name="my-key">value</property>
```



In any case, both options are useable interchangeably, however the later version is recommended by Hazelcast for schema applicability.

### Retrieving a PropertyDefinition Value

To eventually retrieve a value, use the `PropertyDefinition` to get and convert the value automatically.

```
public <T> T getConfig( PropertyDefinition property,
    Map<String, Comparable> properties ) {

    Map<String, Comparable> properties = ...;
    TypeConverter typeConverter = property.typeConverter();

    Comparable value = properties.get( property.key() );
    return typeConverter.convert( value );
}
```

# 25. Hazelcast Plugins

This chapter describes the plugins using which you can extend Hazelcast IMDG's functionalities.

## 25.1. Cloud Discovery Plugins

Hazelcast provides the following plugins that allow Hazelcast cluster members to discover each other on the cloud platforms. Cloud discovery plugins are useful when you do not want to provide or you cannot provide the list of possible IP addresses on various cloud providers.

### 25.1.1. Hazelcast jclouds®

[Apache jclouds®](#) is an open source multi-cloud library for the Java platform which lets you create applications that are portable across clouds and gives you the full control to use cloud-specific features. Hazelcast members and native clients support Apache jclouds® for discovery.

You can configure your cluster to use jclouds® discovery by adding `hazelcast-jclouds.jar` dependency to your project and enabling Hazelcast's Discovery SPI. Since jclouds® depends on various libraries, you also need to configure its dependencies using build automation tools like Maven. Note that you can also define multiple regions in your jclouds® configuration; the members can find each other over a different region.

See Hazelcast jclouds® plugin's [documentation](#) for more information.

### 25.1.2. Hazelcast AWS

[AWS](#) is a comprehensive cloud computing platform provided by Amazon. Hazelcast supports discovering members within Amazon EC2 cloud using Hazelcast AWS cloud discovery plugin.

You can easily configure your cluster to use EC2 discovery by adding `hazelcast-aws.jar` dependency to your project and enabling Hazelcast's Discovery SPI. This plugin does not depend on any other third party modules. Note that this plugin puts the zone information into the Hazelcast's member attributes map during the discovery process; you can use its `ZONE_AWARE` configuration to create backups in other Availability Zones (AZ). Each zone will be accepted as one partition group. Note that, when using the `ZONE_AWARE` partition grouping, a Hazelcast cluster spanning multiple AZs should have an equal number of members in each AZ. Otherwise, it will result in uneven partition distribution among the members.

See Hazelcast AWS plugin's [documentation](#) for more information.

### 25.1.3. Hazelcast GCP

Hazelcast supports discovering members in the [GCP Compute Engine](#) environment.

You can easily configure Hazelcast members discovery, WAN replication and Hazelcast clients to work seamlessly on the native GCP VM Instances. This plugin supports `ZONE_AWARE` configuration to create backups in separate zones to prevent data loss in the case of a zone outage. This plugin also supports discovering a Hazelcast cluster deployed on GCP by the Hazelcast client running outside of

the GCP infrastructure.

See Hazelcast GCP plugin's [documentation](#) for more information.

#### 25.1.4. Hazelcast Azure

[Microsoft Azure](#) is a cloud computing service provided by Microsoft for managing applications through a global network of Microsoft-managed data centers. Hazelcast Azure plugin provides a discovery strategy for Hazelcast enabled applications running on Microsoft Azure. It provides all Hazelcast instances by returning VMs within your Azure resource group that are tagged with a specified value.

To use this plugin in your Java project, simply add the Azure dependency to your Maven or Gradle configurations and enable Hazelcast's Discovery SPI. Then you will need to configure a couple of properties at both Hazelcast and Azure sides.

See Hazelcast Azure plugin's [documentation](#) for more information.

#### 25.1.5. Hazelcast Consul

[Consul](#) is a distributed service mesh to connect, secure and configure services across any public or private cloud platforms. This plugin provides a Consul based discovery strategy for Hazelcast clusters.

You can add the Consul dependency to your Maven or Gradle configurations and enable Hazelcast's Discovery SPI to use this plugin. You can then start Consul in your network and set the Consul related properties in your Hazelcast configuration.

See Hazelcast Consul plugin's [documentation](#) for more information.

#### 25.1.6. Hazelcast etcd

[etcd](#) is an open-source distributed key value store that provides shared configuration and service discovery for Container Linux clusters. This plugin enables the Hazelcast members to dynamically discover each other through etcd.

Add the etcd dependency to either your Maven or Gradle configurations and enable Hazelcast's Discovery SPI. Then start etcd in your network and set the etcd related properties (such username, password and registrator) in your Hazelcast configuration.

See Hazelcast etcd plugin's [documentation](#) for more information.

#### 25.1.7. Hazelcast Eureka

[Eureka](#) is a REST based service that is primarily used in the AWS cloud to for load balancing and failover of middle-tier servers, and Hazelcast supports Eureka V1 discovery.

To use this plugin, add the [hazelcast-eureka-one.jar](#) dependency to your project and enable Hazelcast's Discovery SPI. You will also need to specify the Eureka properties file.

See Hazelcast Eureka plugin's [documentation](#) for more information.

### 25.1.8. Hazelcast IMDG and Jet for PCF

[Pivotal Cloud Foundry](#)(PCF) is an open source cloud platform on which you can build, deploy, run and scale applications. You can deploy your Hazelcast IMDG Enterprise or Hazelcast Jet clusters on PCF using clickable tiles.

After you install and configure Hazelcast IMDG Enterprise or Hazelcast Jet for PCF, you can create services, and configure WAN replications, user code deployments and TLS.

See Hazelcast IMDG Enterprise for PCF [documentation](#) and Hazelcast Jet for PCF [documentation](#) for more information.

### 25.1.9. Hazelcast OpenShift

[OpenShift](#) is an open source container application platform by Red Hat based on top of Docker containers and the Kubernetes container cluster manager for application development and deployment. Hazelcast can run inside OpenShift.

You can use Kubernetes for discovery of Hazelcast members. By using Hazelcast Docker images, templates and default configuration files, you can deploy Hazelcast IMDG, Hazelcast IMDG Enterprise and Management Center onto OpenShift.

See Hazelcast IMDG for OpenShift [documentation](#) and Hazelcast Management Center for OpenShift [documentation](#) for more information.

### 25.1.10. Hazelcast Heroku

[Heroku](#) is a cloud platform as a service supporting several programming languages so that you can build, run and operate applications entirely in the cloud. This plugin offers a discovery strategy that looks for IP addresses of members by resolving service names against the Heroku DNS Discovery in Heroku Private Spaces.

You can use this plugin by adding the `hazelcast-heroku-dependency` to your Maven or Gradle configurations and enabling Hazelcast's Discovery SPI. By default there is no configuration needed, but you can configure the service names or initial run delay for the merge after a Split-Brain.

See Hazelcast Heroku plugin's [documentation](#) for more information.

### 25.1.11. Hazelcast Kubernetes

[Kubernetes](#) is an open source container orchestration system to automate deployment, scaling and management of containerized applications. This plugin looks up the IP addresses of Hazelcast members by resolving the requests against a Kubernetes Service Discovery system. It supports two different options of resolving against the discovery registry: a request to the REST API and DNS lookup against a given DNS service name.

To use this plugin, add the `hazelcast-kubernetes` dependency to your Maven or Gradle configurations and enable Hazelcast's Discovery SPI. You will need to configure Hazelcast according

to the option you want the plugin to use, i.e., REST API or DNS lookup.

See Hazelcast Kubernetes plugin's [documentation](#) for more information.

### 25.1.12. Hazelcast Zookeeper

[Zookeeper](#) by Apache is a centralized service to maintain configuration information, naming, and to provide distributed synchronization and group services. This plugin provides a service based discovery strategy for your Hazelcast applications by using Apache Curator to communicate with your Zookeeper server.

To use this plugin, add the Curator dependencies to your Maven or Gradle configurations and enable Hazelcast's Discovery SPI. Thereafter, you will need to configure properties such as the URL of Zookeeper server and cluster ID.

See Hazelcast Zookeeper plugin's [documentation](#) for more information.

## 25.2. Integration Plugins

Hazelcast provides the following integration plugins that allow Hazelcast to integrate with other frameworks and applications smoothly.

### 25.2.1. Spring Data Hazelcast

[Spring Data](#) provides a consistent, Spring-based programming model for data access while preserving the features of the underlying data store. This plugin provides Spring Data repository support for Hazelcast IMDG. This integration enables the Spring Data paradigm to gain the power of a distributed data repository.

To use this plugin, add the Spring Data dependency to your Maven or Gradle configurations and specify the base packages and repositories.

See Spring Data Hazelcast plugin's [documentation](#) for more information.

### 25.2.2. Spring Integration Extension for Hazelcast

This plugin provides [Spring Integration](#) extensions for Hazelcast. These extensions are included but limited to the following:

- Event-driven inbound channel adapter: Listens related Hazelcast data structure events and sends event messages to the defined channel.
- Continuous query inbound channel adapter: Listens the modifications performed on specific map entries.
- Cluster monitor inbound channel adapter: Listen the modifications performed on the cluster.
- Distributed SQL inbound channel adapter: Runs the defined distributed SQL and returns the results in the light of iteration type.
- Outbound channel adapter: Listens the defined channel and writes the incoming messages to the related distributed data structure.

- Leader election: Elects a cluster member, for example, for highly available message consumer where only one member should receive messages.

See Spring Integration Extension for Hazelcast [documentation](#) for more information.

### 25.2.3. Hazelcast JCA Resource Adapter

Hazelcast JCA Resource Adapter is a system-level software driver which can be used by a Java application to connect to an Hazelcast cluster. Using this adapter, you can integrate Hazelcast into Java EE containers. After a proper configuration, Hazelcast can participate in standard Java EE transactions.

Deploying and configuring the Hazelcast JCA Resource Adapter is not different than configuring any other resource adapters since it is a standard JCA one. However, resource adapter installation and configuration is container-specific, so you will need to consult with your Java EE vendor documentation for details.

See Hazelcast JCA Resource Adapter [documentation](#) for information on configuring the resource adapter, Glassfish applications and JBoss web applications.

#### Integrating with MuleSoft

Hazelcast is embedded within a MuleSoft container as an out-of-the-box offering. For a proper integration you should edit the `mule-deploy.properties` file to have the following entry:

```
loader.override=com.hazelcast
```

### 25.2.4. Hazelcast Grails

[Grails](#) is an open source web application framework that uses the Apache Groovy programming language. This plugin integrates Hazelcast data distribution framework into your Grails application. You can reach the distributed data structures by injecting the [HazelService](#). Also you can cache your domain class into Hazelcast distributed cache.

See Hazelcast Grails plugin's [documentation](#) and [this blogpost](#) for more information.

### 25.2.5. Hazelcast Hibernate 2LC

[Hibernate](#) is an object-relational mapping tool for the Java programming language. It provides a framework for mapping an object-oriented domain model to a relational database and enables developers to more easily write applications whose data outlives the application process. This plugin provides Hazelcast's own distributed second level cache implementation for your Hibernate (versions 3, 4 and 5) entities, collections and queries.

To use this plugin, add the Hazelcast Hibernate dependency into your classpath depending on your Hibernate version. Then you will need to specify various properties in your Hibernate configuration such as the `RegionFactory` and query cache properties.

See the documentation of this plugin for [Hibernate 3.x, 4.x](#) and for [Hibernate 5.x](#).

### 25.2.6. Hazelcast DynaCache

[DynaCache](#) by IBM is used to store objects, and later, based on some data matching rules, to retrieve those objects and serve them from its cache. This plugin is for Liberty Profile which is a lightweight profile of IBM WebSphere Application Server.

In the Liberty Profile, you can use a dynamic cache engine in order to cache your data. With this plugin, you can use Hazelcast as a cache provider.

See Hazelcast DynaCache plugin's [documentation](#) for more information.

### 25.2.7. Hazelcast Connector for Kafka

This plugin allows you to write events from [Kafka](#) to HazelCast. It takes the value from the Kafka Connect SinkRecords and inserts/updates an entry in Hazelcast. It supports writing to Hazelcast distributed data structures including Reliable Topic, Ringbuffer, Queue, Set, List, Map, MultiMap and ICache (Hazelcast's JCache extension).

See the plugin's [documentation](#) for more information.

### 25.2.8. Openfire

[Openfire](#) is an open source real time collaboration server. It uses XMPP which is an open protocol for instant messaging. This plugin adds support for running multiple redundant Openfire servers together in a cluster.

By running Openfire as a cluster, you can distribute the connection load among several servers, while also providing failover in the event of failures.

See the plugin's [documentation](#) for more information.

### 25.2.9. SubZero

[Kryo](#) is a popular serialization library. It is fast, easy to use, and it does not pollute your domain model. It can even serialize classes which are not marked as Serializable.

Hazelcast has no out-of-the box support for Kryo. Although it is rather easy to integrate it, everyone has to write the same code and face the same bugs. This plugin, SubZero, simplifies the integration of Hazelcast and Kryo. Simply add SubZero dependency to your Maven or Gradle configurations, and add the SubZero plugin as a global serializer (if you want to use it for all classes in your project) or as a serializer (to have the option of selecting the classes in your project).

See the plugin's [documentation](#) for more information.

## 25.3. Web Sessions Clustering Plugins

Hazelcast offers the following plugins to allow you cluster your web sessions using Servlet Filter, Tomcat and Jetty based solutions.



### 25.3.1. Filter Based Web Session Replication

This plugin (a.k.a. Generic Web Session Replication) provides HTTP session replication capabilities across a Hazelcast cluster in order to handle failover cases. Assuming you have multiple web servers with load balancers; if one server goes down, your users on that server will be directed to one of the other live servers, but their sessions will be lost. Using this plugin backs up these HTTP sessions; it clusters them automatically. To use it, put the `hazelcast-wm` JAR file into your `WEB-INF/lib` folder and configure your `web.xml` file according to your needs.

See the plugin's [documentation](#) for information on configuring and using it.

You can also see the [sample application](#) which uses filter based web session replication.

Note that filter based web session replication has the option to use a map with High-Density Memory Store, is available in **Hazelcast IMDG Enterprise HD**, to keep your session objects. Please refer to the [High-Density Memory Store section](#) for details on this feature.

### 25.3.2. Tomcat Based Web Session Replication

Tomcat based web session replication is offered through Hazelcast Tomcat Session Manager. It is a container specific module that enables session replication for JEE Web Applications without requiring changes to the application.

See the plugin's [documentation](#) for information on configuring and using it.

You can also see the [sample application](#) which uses Tomcat based web session replication.

### 25.3.3. Jetty Based Web Session Replication

Jetty based web session replication is offered through Hazelcast Jetty Session Manager. It is a container specific module that enables session replication for JEE Web Applications without requiring changes to the application.

See the plugin's [documentation](#) for information on configuring and using it.

You can also see the [sample application](#) which uses Jetty based web session replication.

## 25.4. Big Data Plugins

Hazelcast offers integrations with [Apache Spark](#) and [Apache Mesos](#).

Apache Spark is an open source cluster-computing platform which has become one of the key big data distributed processing frameworks. There is a Spark connector for Hazelcast which allows your Spark applications to connect to a Hazelcast cluster with the Spark RDD API. See this integration's [documentation](#) for information on configuring and using it.

Apache Mesos is an open source cluster manager that handles workloads efficiently in a distributed environment through dynamic resource sharing and isolation; you can run any distributed application that requires clustered resources. It is widely used to manage big data infrastructures. Hazelcast Mesos integration gives you the ability to deploy Hazelcast on the Mesos cluster. See this

integration's [documentation](#) for information on configuring and using it.

## 26. Consistency and Replication Model

### 26.1. A Brief Overview of Consistency and Replication in Distributed Systems

Partitioning and replication are the two common techniques used together in distributed databases to achieve scalable, available and transparent data distribution. The data space is divided into partitions, each of which contains a distinct portion of the overall data set. For these partitions, multiple copies called replicas are created. Partition replicas are distributed among the cluster members. Each member is assigned to at most a single replica for a partition. In this setting, different replication techniques can be used to access the data and keep the replicas in sync on updates. The technique being used directly affects the guarantees and properties a distributed data store provides, due to the CAP (Consistency, Availability and Partition Tolerance) principle.

One aspect of replication techniques is about where a replicated data set is accessed and updated. For instance, primary-copy systems first elect a replica, which can be called as primary, master, etc., and use that replica to access the data. Changes in the data on the primary replica are propagated to other replicas. This approach has different namings, such as *primary-copy*, *single-master*, *passive replication*. The primary-copy technique is a powerful model as it prevents conflicts, deadlocks among the replicas. However, primary replicas can become bottlenecks. On the other hand, we can have a different technique by eliminating the primary-copy and treating each replica as equal. These systems can achieve a higher level of availability as a data entry can be accessed and updated using any replica. However, it can become more difficult to keep the replicas in sync with each other.

Replication techniques also differ in how updates are propagated among replicas.

- One option is to update each replica as part of a single atomic transaction, called as *eager replication* or *synchronous replication*. Consensus algorithms apply this approach to achieve strong consistency on a replicated data set. The main drawback is the amount of coordination and communication required while running the replication algorithm. CP systems implement consensus algorithms under the hood.
- Another option is the *lazy replication* technique, which is also called as *asynchronous replication*. Lazy replication algorithms execute updates on replicas with separate transactions. They generally work with best-effort. By this way, the amount of coordination among the replicas are degraded and data can be accessed in a more performant manner. Yet, it can happen that a particular update is executed on some replicas but not on others, which will lead replicas to diverge. Such problems can be resolved with different approaches, such as *read-repair*, *write-repair*, *anti-entropy*. Lazy replication techniques are popular among AP systems.

### 26.2. Hazelcast's Replication Algorithm

The discussion here generally applies to any system that maintains multiple copies of a data set. It applies to Hazelcast as well. In the context of CAP principle, **Hazelcast is an AP product**, which

employs the combination of primary-copy and lazy replication techniques. As briefly described in the [Data Partitioning section](#), each data entry is mapped to a single Hazelcast partition and put into replicas of that partition. One of the replicas is elected as the primary replica, which is responsible for performing operations on that partition. When you read or write a map entry, you transparently talk to the Hazelcast member to which primary replica of the corresponding partition is assigned. By this way, each request hits the most up-to-date version of a particular data entry in a stable cluster. Backup replicas stay in standby mode until the primary replica fails. Upon failure of the primary replica, one of the backup replicas are promoted to the primary role.

With *lazy replication*, when the primary replica receives an update operation for a key, it executes the update locally and propagates it to backup replicas. It marks each update with a logical timestamp so that backups apply them in the correct order and converge to the same state with the primary. Backup replicas can be used to scale reads (see the [Enabling Backup Reads section](#)) with no strong consistency but monotonic reads guarantee.

Hazelcast offers features such as *Quorum*, *ILock*, *AtomicLong*, etc. In the journey of being a highly elastic, dynamic and easy to use product, Hazelcast tries to provide best-effort consistency guarantees without being a complete CP solution. Therefore, we recommend these features to be used for efficiency purposes in general, instead of correctness. For instance, they can be used to prevent to run a resource-extensive computation multiple times, which would not create any correctness problem if runs more than once. Please refer to [Best-Effort Consistency](#) and [Network Partitioning](#) sections for more information.

### 26.2.1. Best-Effort Consistency

Hazelcast's replication technique enables Hazelcast clusters to offer high throughput. However, due to temporary situations in the system, such as network interruption, backup replicas can miss some updates and diverge from the primary. Backup replicas can also hit VM or long GC pauses, and fall behind the primary, which is a situation called as *replication lag*. If a Hazelcast partition primary replica member crashes while there is a replication lag between itself and the backups, strong consistency of the data can be lost.

Please note that CP systems can have similar problems as well. However, in a CP system, once a replica performs an update locally (i.e., *commits* the update), the underlying consensus algorithm guarantees durability of the update for the rest of the execution.

On the other hand, in AP systems like Hazelcast, a replica can perform an update locally, even if the update is not to be performed on other replicas. This is a fair trade-off to reduce amount of coordination among replicas and maintain high throughput & high availability of the system. These systems employ additional measurements to maintain consistency in a best-effort manner. In this regard, Hazelcast tries to minimize effect of such scenarios using an active anti-entropy solution as follows:

- Each Hazelcast member runs a periodic task in the background.
- For each primary replica it is assigned, it creates a summary information and sends it to the backups.
- Then, each backup member compares the summary information with its own data to see if it is up-to-date with the primary.

- If a backup member detects a missing update, it triggers the synchronization process with the primary.

## 26.3. Invocation Lifecycle

When a write is requested with the methods, such as `map.put()` or `queue.offer()`, a write operation is submitted to the Hazelcast member that owns the primary replica of the specific partition. Partition of an operation is determined based on a parameter (key of an entry or name of the data structure, etc.) related to that operation depending on the data structure. Target Hazelcast member is figured out by looking up a local partition assignment/ownership table, which is updated on each partition migration and broadcasted to all cluster eventually.

When a Hazelcast member receives a partition specific operation, it executes the operation and propagates it to backup replica(s) with a logical timestamp. Number of backups for each operation depends on the data structure and its configuration. See [Threading Model - Operation Threading](#) for threading details.

Two types of backup replication are available: *sync* and *async*. Despite what their names imply, both types are still implementations of the lazy (async) replication model. The only difference between *sync* and *async* is that, the former makes the caller block until backup updates are applied by backup replicas and acknowledgments are sent back to the caller, but the latter is just fire & forget. Number of sync and async backups are defined in the data structure configurations, and you can use a combination of sync and async backups.

When backup updates are propagated, response of the execution including number of sync backup updates is sent to the caller and after receiving the response, caller waits to receive the specified number of sync backup acknowledgements for a predefined timeout. This timeout is 5 seconds by default and defined by the system property `hazelcast.operation.backup.timeout.millis` (see [System Properties appendix](#)).

A backup update can be missed because of a few reasons, such as a stale partition table information on a backup replica member, network interruption, or a member crash. That's why sync backup acks require a timeout to give up. Regardless of being a sync or async backup, if a backup update is missed, the periodically running anti-entropy mechanism detects the inconsistency and synchronizes backup replicas with the primary. Also the graceful shutdown procedure ensures that all backup replicas for partitions whose primary replicas are assigned to the shutting down member will be consistent.

In some cases, although the target member of an invocation is assumed to be alive by the failure detector, the target may not execute the operation or send the response back in time. Network splits, long pauses caused by high load, GC or IO (disk, network) can be listed as a few possible reasons. When an invocation doesn't receive any response from the member that owns primary replica, then invocation fails with an `OperationTimeoutException`. This timeout is 2 minutes by default and defined by the system property `hazelcast.operation.call.timeout.millis` (see [System Properties appendix](#)). When timeout is passed, result of the invocation will be indeterminate.

## 26.4. Exactly-once, At-least-once or At-most-once Execution

Hazelcast, as an AP product, does not provide the exactly-once guarantee. In general, Hazelcast tends to be an at-least-once solution.

In the following failure case, exactly-once guarantee can be broken:

- When the target member of a pending invocation leaves the cluster while the invocation is waiting for a response, that invocation is re-submitted to its new target due to the new partition table. It can be that, it has already been executed on the leaving member and backup updates are propagated to the backup replicas, but the response is not received by the caller. If that happens, the operation will be executed twice.

In the following failure case, invocation state will become indeterminate:

- As explained above, when an invocation does not receive a response in time, invocation will fail with an `OperationTimeoutException`. This exception does not say anything about outcome of the operation, that means operation may not be executed at all, it may be executed once or twice (due to member left case explained above).

## 26.5. IndeterminateOperationStateException

As described in [Invocation Lifecycle](#) section, for partition-based **mutating** invocations, such as `map.put()`, a caller waits with a timeout for the operation that is executed on corresponding partition's primary replica and backup replicas, based on the sync backup configuration of the distributed data structure. Hazelcast 3.9 introduces a new mechanism to detect indeterminate situations while making such invocations. If `hazelcast.operation.fail.on.indeterminate.state` system property is enabled, a **mutating** invocation throws `IndeterminateOperationStateException` when it encounters the following cases:

- The operation fails on partition primary replica member with `MemberLeftException`. In this case, the caller may not determine the status of the operation. It could happen that the primary replica executes the operation, but fails before replicating it to all the required backup replicas. Even if the caller receives backup acks from some backup replicas, it cannot decide if it has received all required ack responses, since it does not know how many acks it should wait for.
- There is at least one missing ack from the backup replicas for the given timeout duration. In this case, the caller knows that the operation is executed on the primary replica, but some backup may have missed it. It could be also a false-positive, if the backup timeout duration is configured with a very small value. However, Hazelcast's active anti-entropy mechanism eventually kicks in and resolves durability of the write on all available backup replicas as long as the primary replica member is alive.

When an invocation fails with `IndeterminateOperationStateException`, the system does not try to rollback the changes which are executed on healthy replicas. Effect of a failed invocation may be even observed by another caller, if the invocation has succeeded on the primary replica. Hence, this new behavior does not guarantee linearizability. However, if an invocation completes without `IndeterminateOperationStateException` when the configuration is enabled, it is guaranteed that the

operation has been executed exactly-once on the primary replica and specified number of backup replicas of the partition.

Please note that `IndeterminateOperationStateException` does not apply to read-only operations, such as `map.get()`. If a partition primary replica member crashes before replying to a read-only operation, the operation is retried on the new owner of the primary replica.

## 27. Network Partitioning

### 27.1. Split-Brain Syndrome

In general, network partitioning is a network failure that causes the members to split into multiple groups such that a member in a group cannot communicate with members in other groups. In a partition scenario, all sides of the original cluster will operate independently assuming members in other sides are failed. Network partitioning is also called as *Split-Brain Syndrome*.

Even though this communication failure is called as *network partitioning*, in practice a process or an entire OS that's suspending/pausing very long can cause communication interruptions. If these interruptions take long enough time to assume that the other side is crashed, the cluster splits into multiple partitions and they start operating independently. That's why any communication failure/interruption long enough can be classified as network partitioning.

Moreover, communication failures don't have to be symmetrical. A network failure can interrupt only one side of the channel or a suspended process/member may not even observe the rest as crashed. That kind of network partitioning can be called as *partial network partitioning*.

### 27.2. Dealing with Network Partitions

Hazelcast handles network partitions using the following solutions:

- **Split-Brain Protection (Quorums):** Split-Brain Protection could be used when consistency is the major concern on a network partitioning. It requires a minimum cluster size to keep a particular data structure available. When cluster size is below the defined quorum size, then subsequent operations will be rejected with a `QuorumException`. See [Split-Brain Protection section](#).
- **Split-Brain Recovery (Merge Policies):** Split-Brain Recovery is to make data structures available and operational on both sides of a network partition, and merge their data once the network partitioning problem is resolved. See [Split-Brain Recovery section](#).



Starting with Hazelcast 3.10, Split-Brain Recovery is supported for the data structures whose in-memory format is `NATIVE`.

### 27.3. Split-Brain Protection



The term "quorum" used in this section simply refers to the count of members in the cluster. It does NOT refer to an implementation of Paxos or Raft protocols as used in some NoSQL systems. The mechanism provided in Hazelcast protects the user in case the number of members in a cluster drops below the specified one.

How to respond to a split-brain scenario depends on whether consistency of data or availability of your application is of primary concern. In either case, because a split-brain scenario is caused by a network failure, you must initiate an effort to identify and correct the network failure. Your cluster cannot be brought back to steady state operation until the underlying network failure is fixed. If consistency is your primary concern, you can use Hazelcast's Split-Brain Protection feature.

Hazelcast's Split-Brain Protection enables you to specify the minimum cluster size required for operations to occur. This is achieved by defining and configuring a Split-Brain Protection Cluster Quorum. If the cluster size is below the defined quorum, the operations are rejected and the rejected operations return a `QuorumException` to their callers. Additionally, it is possible to configure a quorum with a user-defined `QuorumFunction` which will be consulted to determine presence of quorum on each cluster membership change.

Your application continues its operations on the remaining operating cluster. Any application instances connected to the cluster with sizes below the defined quorum will be receiving exceptions which, depending on the programming and monitoring setup, should generate alerts. The key point is that rather than applications continuing in error with stale data, they are prevented from doing so.

Split-Brain Protection is supported for the following Hazelcast data structures:

- IMap (for Hazelcast 3.5 and higher versions)
- Transactional Map (for Hazelcast 3.5 and higher versions)
- ICache (for Hazelcast 3.5 and higher versions)
- ILock (for Hazelcast 3.8 and higher versions)
- IQueue (for Hazelcast 3.8 and higher versions)
- IExecutorService, DurableExecutorService, IScheduledExecutorService, MultiMap, ISet, IList, Ringbuffer, Replicated Map, Cardinality Estimator, IAtomicLong, IAtomicReference, ISemaphore, ICountdownLatch (for Hazelcast 3.10 and higher versions)

Each data structure to be protected should have the configuration added to it as explained in the [Configuring Split-Brain Protection section](#).

### 27.3.1. Time Window for Split-Brain Protection

Cluster Membership is established and maintained by heartbeats. A network partitioning will present some members as being unreachable. While configurable, it is normally seconds or tens of seconds before the cluster is adjusted to exclude unreachable members. The cluster size is based on the currently understood number of members.

For this reason, there will be a time window between the network partitioning and the application of Split-Brain Protection, a time window to detect quorum is not satisfied anymore. Length of this

window depends on the failure detector. Given guarantee is, every member will eventually detect the failed members and will reject the operation on the data structure which requires the quorum.

Starting with Hazelcast 3.10, Split-Brain Protection can be configured with new out-of-the-box `QuorumFunction`s which determine presence of quorum independently of the cluster membership manager, taking advantage of heartbeat and other failure-detector information configured on Hazelcast members.

For more information, please see the [Consistency and Replication Model chapter](#).

### 27.3.2. Configuring Split-Brain Protection

You can set up Split-Brain Protection Cluster Quorum using either declarative or programmatic configuration.

Assume that you have a 7-member Hazelcast Cluster and you want to set the minimum number of four members for the cluster to continue operating. In this case, if a split-brain happens, the sub-clusters of sizes 1, 2 and 3 will be prevented from being used. Only the sub-cluster of four members will be allowed to be used.



It is preferable to have an odd-sized initial cluster size to prevent a single network partitioning (split-brain) from creating two equal sized clusters.

#### Member Count Quorum

This type of quorum function determines the presence of quorum based on the count of members in the cluster, as observed by the local member's cluster membership manager and is available since Hazelcast 3.5. The following are map configurations for the example 7-member cluster scenario described above:

#### Declarative configuration:

```
<hazelcast>
....
<quorum name="quorumRuleWithFourMembers" enabled="true">
  <quorum-size>4</quorum-size>
</quorum>

<map name="default">
  <quorum-ref>quorumRuleWithFourMembers</quorum-ref>
</map>
....
</hazelcast>
```

#### Programmatic configuration:



```

QuorumConfig quorumConfig = new QuorumConfig();
quorumConfig.setName("quorumRuleWithFourMembers");
quorumConfig.setEnabled(true);
quorumConfig.setSize(4);

MapConfig mapConfig = new MapConfig();
mapConfig.setQuorumName("quorumRuleWithFourMembers");

Config config = new Config();
config.addQuorumConfig(quorumConfig);
config.addMapConfig(mapConfig);

```

## Probabilistic Quorum Function

The probabilistic quorum function uses a private instance of [Phi Accrual Cluster Failure Detector](#) which is updated with member heartbeats and its parameters can be fine-tuned to determine the count of live members in the cluster, independently of the cluster's membership manager.

The probabilistic quorum function can be configured with the following parameters:

Parameter	Default Value	Description
<code>acceptable-heartbeat-pause-millis</code>	60000	Duration in milliseconds corresponding to number of potentially lost/delayed heartbeats that will be accepted before considering it to be an anomaly. This margin is important to be able to survive sudden, occasional, pauses in heartbeat arrivals, due to for example garbage collection or network drops. Value must be in range $[\text{heartbeat interval}, \text{maximum no heartbeat interval}]$ , otherwise Hazelcast will not start.
<code>suspicion-threshold</code>	10	Threshold for suspicion ( $\phi$ ) level. A low threshold is prone to generate many wrong suspicions but ensures a quick detection in the event of a real crash. Conversely, a high threshold generates fewer mistakes but needs more time to detect actual crashes.
<code>max-sample-size</code>	200	Number of samples to use for calculation of mean and standard deviation of inter-arrival times.

Parameter	Default Value	Description
<code>heartbeat-interval-millis</code>	5000	Bootstrap the stats with heartbeats that corresponds to this duration in milliseconds, with a rather high standard deviation (since environment is unknown in the beginning).
<code>min-std-deviation-millis</code>	100	Minimum standard deviation (in milliseconds) to use for the normal distribution used when calculating phi. Too low standard deviation might result in too much sensitivity for sudden, but normal, deviations in heartbeat inter arrival times.

## Declarative configuration

```

<hazelcast>
  ...
  <quorum enabled="true" name="probabilistic-quorum">
    <quorum-size>3</quorum-size>
    <quorum-type>READ_WRITE</quorum-type>
    <probabilistic-quorum acceptable-heartbeat-pause-millis="5000"
      max-sample-size="500" suspicion-threshold="10" />
  </quorum>
  <set name="split-brain-protected-set">
    <quorum-ref>probabilistic-quorum</quorum-ref>
  </set>
</hazelcast>

```

## Programmatic configuration

```

QuorumConfig quorumConfig =
    QuorumConfig.newProbabilisticQuorumConfigBuilder("probabilist-quorum", 3)
        .withAcceptableHeartbeatPauseMillis(5000)
        .withMaxSampleSize(500)
        .withSuspicionThreshold(10)
        .build();
quorumConfig.setType(QuorumType.READ_WRITE);
SetConfig setConfig = new SetConfig("split-brain-protected-set");
setConfig.setQuorumName("probabilist-quorum");
Config config = new Config();
config.addQuorumConfig(quorumConfig);
config.addSetConfig(setConfig);

```

## Recently-Active Quorum Function

A quorum with a recently-active quorum function can be used to implement more conservative split-brain protection by requiring that a heartbeat has been received from each member within a configurable time window since now.

### Declarative configuration

```
<hazelcast>
  ...
  <quorum enabled="true" name="recently-active-quorum">
    <quorum-size>4</quorum-size>
    <quorum-type>READ_WRITE</quorum-type>
    <recently-active-quorum heartbeat-tolerance-millis="60000" />
  </quorum>
  <set name="split-brain-protected-set">
    <quorum-ref>recently-active-quorum</quorum-ref>
  </set>
</hazelcast>
```

### Programmatic configuration

```
QuorumConfig quorumConfig =
    QuorumConfig.newRecentlyActiveQuorumConfigBuilder("recently-active-quorum", 4,
60000)
        .build();
quorumConfig.setType(QuorumType.READ_WRITE);
SetConfig setConfig = new SetConfig("split-brain-protected-set");
setConfig.setQuorumName("recently-active-quorum");
Config config = new Config();
config.addQuorumConfig(quorumConfig);
config.addSetConfig(setConfig);
```

## Quorum Configuration Reference

Quorum configuration has the following elements:

- **quorum-size**: Minimum number of members required in a cluster for the cluster to remain in an operational state. If the number of members is below the defined minimum at any time, the operations are rejected and the rejected operations return a `QuorumException` to their callers.
- **quorum-type**: Type of the cluster quorum. Available values are READ, WRITE and READ\_WRITE.
- **quorum-function-class-name**: Class name of a `QuorumFunction` implementation, allows to configure Split-Brain Protection with a custom quorum function. It cannot be used in conjunction with `probabilistic-quorum` or `recently-active-quorum`.
- **quorum-listeners**: Declaration of quorum listeners which are notified on quorum status changes.
- **8 probabilistic-quorum**: Configures the quorum with a probabilistic quorum function. It cannot be used in conjunction with `quorum-function-class-name` or `recently-active-quorum`.

- **recently-active-quorum**: Configures the quorum with a recently-active quorum function. It cannot be used in conjunction with **quorum-function-class-name** or **probabilistic-quorum**.

### Sample configuration with custom QuorumFunction implementation

```
package my.domain;

public class CustomQuorumFunction implements QuorumFunction {
    @Override
    public boolean apply(Collection<Member> members) {
        // implement quorum detection logic here
    }
}
```

```
<quorum enabled="true" name="member-count-quorum">
  <quorum-type>READ_WRITE</quorum-type>
  <quorum-size>3</quorum-size>
  <quorum-function-class-name>my.domain.CustomQuorumFunction</quorum-function-class-
name>
</quorum>
```

### 27.3.3. Configuring Quorum Listeners

You can register quorum listeners to be notified about quorum results. Quorum listeners are local to the member where they are registered, so they receive only events that occurred on that local member.

Quorum listeners can be configured via declarative or programmatic configuration. The following examples are such configurations.

#### Declarative:

```
<hazelcast>
  ....
  <quorum name="quorumRuleWithFourMembers" enabled="true">
    <quorum-size>4</quorum-size>
    <quorum-listeners>
      <quorum-listener>com.company.quorum.FourMemberQuorumListener</quorum-listener>
    </quorum-listeners>
  </quorum>

  <map name="default">
    <quorum-ref>quorumRuleWithFourMembers</quorum-ref>
  </map>
  ....
</hazelcast>
```

## Programmatic:

```
QuorumListenerConfig listenerConfig = new QuorumListenerConfig();
// You can either directly set quorum listener implementation of your own
listenerConfig.setImplementation(new QuorumListener() {
    @Override
    public void onChange(QuorumEvent quorumEvent) {
        if (quorumEvent.isPresent()) {
            // handle quorum presence
        } else {
            // handle quorum absence
        }
    }
});
// Or you can give the name of the class that implements QuorumListener interface.
listenerConfig.setClassName("com.company.quorum.ThreeMemberQuorumListener");

QuorumConfig quorumConfig = new QuorumConfig();
quorumConfig.setName("quorumRuleWithFourMembers");
quorumConfig.setEnabled(true);
quorumConfig.setSize(4);
quorumConfig.addListenerConfig(listenerConfig);

MapConfig mapConfig = new MapConfig();
mapConfig.setQuorumName("quorumRuleWithFourMembers");

Config config = new Config();
config.addQuorumConfig(quorumConfig);
config.addMapConfig(mapConfig);
```

### 27.3.4. Querying Quorum Results

Split-Brain Protection Quorum service gives you the ability to query quorum results over the **Quorum** instances. Quorum instances let you query the result of a particular quorum.

Here is a Quorum interface that you can interact with.

```

/**
 * {@link Quorum} provides access to the current status of a quorum.
 */
public interface Quorum {
    /**
     * Returns true if quorum is present, false if absent.
     *
     * @return boolean presence of the quorum
     */
    boolean isPresent();
}

```

You can retrieve the quorum instance for a particular quorum over the quorum service, as in the following example.

```

String quorumName = "at-least-one-storage-member";
QuorumConfig quorumConfig = new QuorumConfig();
quorumConfig.setName(quorumName);
quorumConfig.setEnabled(true);

MapConfig mapConfig = new MapConfig();
mapConfig.setQuorumName(quorumName);

Config config = new Config();
config.addQuorumConfig(quorumConfig);
config.addMapConfig(mapConfig);

HazelcastInstance hazelcastInstance = Hazelcast.newHazelcastInstance(config);
QuorumService quorumService = hazelcastInstance.getQuorumService();
Quorum quorum = quorumService.getQuorum(quorumName);

boolean quorumPresence = quorum.isPresent();

```

## 27.4. Split-Brain Recovery

Hazelcast deploys a background task that periodically searches for split clusters. When a split is detected, the side that will initiate the merge process is decided. This decision is based on the cluster size; the smaller cluster, by member count, will merge into the bigger one. If they have an equal number of members, then a hashing algorithm determines the merging cluster. When deciding the merging side, both sides ensure that there's no intersection in their member lists.

After the merging side is decided, the master member (the eldest one) of the merging side initiates the cluster merge process by sending merge instructions to the members in its cluster.

While recovering from partitioning, Hazelcast uses merge policies for supported data structures to resolve data conflicts between split clusters. A merge policy is a callback function to resolve conflicts between the existing and merging data. Hazelcast provides an interface to be implemented

and also a selection of out-of-the-box policies. Data structures without split-brain support discard the data from merging side.

Each member of the merging cluster will do the following:

- Close all of its network connections (detach from its cluster).
- Take a snapshot of local data structures which support split-brain recovery.
- Discard all data structure data.
- Join to the new cluster as lite member.
- Send merge operations to the new cluster from local snapshots.

For more information, please see the [Consistency and Replication Model chapter](#).

### 27.4.1. Merge Policies

Since Hazelcast 3.10 all merge policies implement the unified interface `com.hazelcast.spi.SplitBrainMergePolicy`. We provide the following out-of-the-box implementations:

- `DiscardMergePolicy`: the entry from the smaller cluster will be discarded.
- `ExpirationTimeMergePolicy`: the entry with the higher expiration time wins.
- `HigherHitsMergePolicy`: the entry with the higher number of hits wins.
- `HyperLogLogMergePolicy`: specialized merge policy for the `CardinalityEstimator`, which uses the default merge algorithm from HyperLogLog research, keeping the max register value of the two given instances.
- `LatestAccessMergePolicy`: the entry with the latest access wins.
- `LatestUpdateMergePolicy`: the entry with the latest update wins.
- `PassThroughMergePolicy`: the entry from the smaller cluster wins.
- `PutIfAbsentMergePolicy`: the entry from the smaller cluster wins if it doesn't exist in the cluster.

Additionally you can develop a custom merge policy by implementing the `SplitBrainMergePolicy` interface, as explained in the [Custom Merge Policies section](#)

### 27.4.2. Supported Data Structures

The following data structures support split-brain recovery:

- `IMap` (including High-Density Memory Store backed IMap)
- `ICache` (including High-Density Memory Store backed IMap)
- `ReplicatedMap`
- `MultiMap`
- `IAtomicLong`
- `IAtomicReference`
- `IQueue`

- `IList`
- `ISet`
- `RingBuffer`
- `CardinalityEstimator`
- `ScheduledExecutorService`

The statistic based out-of-the-box merge policies are only supported by `IMap`, `ICache`, `ReplicatedMap` and `MultiMap`. The `HyperLogLogMergePolicy` is supported by the `CardinalityEstimator`.



Except the `CardinalityEstimator` data structure, the default merge policy for all the Hazelcast data structures that support split-brain recovery (listed above) is `PutIfAbsentMergePolicy`. For the `CardinalityEstimator` data structure, the default merge policy is `HyperLogLogMergePolicy`.

See also the [Merge Types section](#) for a complete overview of supported merge types of each data structure. There is a config validation which checks these constraints to provide fail-fast behavior for invalid configurations.



For the other data structures, e.g., `ISemaphore`, `ICountdownLatch` and `ILock`, the instance from the smaller cluster is discarded during the split-brain recovery.

### 27.4.3. Configuring Merge Policies

The merge policies are configured via a `MergePolicyConfig`, which can be set for all supported data structures. The only exception is `ICache`, which just accepts the merge policy classname (due to compatibility reasons with older Hazelcast clients). For `ICache`, all other configurable merge parameters are the default values from `MergePolicyConfig`.

For custom merge policies you should set the full class name of your implementation as the `merge-policy` configuration. For the out-of-the-box merge policies the simple classname is enough.

#### Declarative Configuration

Here are examples how merge policies can be specified for various data structures:



```

<hazelcast>
  ...
  <map name="default">
    ...
    <merge-policy batch-size="100">LatestUpdateMergePolicy</merge-policy>
  </map>

  <replicatedmap name="default">
    ...
    <merge-policy batch-size="100">org.example.merge.MyMergePolicy</merge-policy>
  </replicatedmap>

  <multimap name="default">
    ...
    <merge-policy batch-size="50">HigherHitsMergePolicy</merge-policy>
  </multimap>

  <list name="default">
    ...
    <merge-policy batch-size="500">org.example.merge.MyMergePolicy</merge-policy>
  </list>

  <atomic-long name="default">
    ...
    <merge-policy>PutIfAbsentMergePolicy</merge-policy>
  </atomic-long>
  ...
</hazelcast>

```

Here is how merge policies are specified for `ICache` (it is the same configuration tag, but lacks the support for additional attributes like `batch-size`):

```

<hazelcast>
  ...
  <cache name="default">
    ...
    <merge-policy>org.example.merge.MyMergePolicy</merge-policy>
  </cache>
</hazelcast>

```

## Programmatic Configuration

Here are examples how merge policies can be specified for various data structures:

```

MergePolicyConfig mergePolicyConfig = new MergePolicyConfig()
    .setPolicy("org.example.merge.MyMergePolicy")
    .setBatchSize(100);

MapConfig mapConfig = new MapConfig("default")
    .setMergePolicyConfig(mergePolicyConfig);

ListConfig listConfig = new ListConfig("default")
    .setMergePolicyConfig(mergePolicyConfig);

Config config = new Config()
    .addMapConfig(mapConfig)
    .addListConfig(listConfig);

```

Here is how merge policies are specified for `ICache` (you can only set the merge policy classname):

```

CacheConfig mapConfig = new CacheConfig()
    .setName("default")
    .setMergePolicy("org.example.merge.MyMergePolicy");

Config config = new Config()
    .addMapConfig(mapConfig);

```

#### 27.4.4. Custom Merge Policies

To implement a custom merge policy you have to implement `com.hazelcast.spi.SplitBrainMergePolicy`:

```

public interface SplitBrainMergePolicy<V, T extends MergingValue<V>>
    extends DataSerializable {

    V merge(T mergingValue, T existingValue);
}

```

`MergingValue` is an interface which describes a merge type.



Please have in mind that `existingValue` can be `null`. This happens when a data structure or key-based entry was just created in the smaller cluster.

#### Merge Types

A merge type defines an attribute which is required by a merge policy and provided by a data structure.

`MergingValue` is the base type, which is required by all merge policies and provided by all data structures. It contains the value of the merged data in raw and deserialized format:

```
public interface MergingValue<V> {
    V getValue();
    <DV> DV getDeserializedValue();
}
```

The most common extension is `MergingEntry`, which additionally provides the key in raw and deserialized format (used by all key-based data structures like `IMap` or `ICache`):

```
public interface MergingEntry<K, V> extends MergingValue<V> {
    K getKey();
    <DK> DK getDeserializedKey();
}
```

In addition we have a bunch of specialized merge types, e.g., for provided statistics. An example is `MergingHits`, which provides the hit counter of the merge data:

```
public interface MergingHits<V> extends MergingValue<V> {
    long getHits();
}
```

The class `com.hazelcast.spi.merge.SplitBrainMergeTypes` contains composed interfaces, which show the provided merge types and required merge policy return type for each data structure:

```
public interface ReplicatedMapMergeTypes extends MergingEntry<Object, Object>,
    MergingCreationTime<Object>, MergingHits<Object>, MergingLastAccessTime<Object>,
    MergingLastUpdateTime<Object>, MergingTTL<Object> {
}

public interface QueueMergeTypes extends MergingValue<Collection<Object>> {
}
```

The `ReplicatedMap` provides key/value merge data, with the creation time, access hits, last access time, last update time and TTL. The return type of the merge policy is `Object`.

The `IQueue` just provides a collection of values. The return type is also a `Collection<Object>`.

The following is the full list of merge types:

- `MergingValue`: Represents the value of the merged data.
- `MergingEntry`: Represents the key and value of the merged data.

- **MergingCreationTime**: Represents the creation time of the merging process.
- **MergingHits**: Represents the access hits of the merged data.
- **MergingLastAccessTime**: Represents the last time when the merged data is accessed.
- **MergingLastUpdateTime**: Represents the last time when the merged data is updated.
- **MergingTTL**: Represents the time-to-live value of the merged data.
- **MergingMaxIdle**: Represents the maximum idle timeout value of the merged data.
- **MergingCost**: Represents the memory costs for the merging process after a split-brain.
- **MergingVersion**: Represents the version of the merged data.
- **MergingExpirationTime**: Represents the expiration time of the merged data.
- **MergingLastStoredTime**: Represents the last stored time of the merged data.

And the following table shows the merge types provided by each data structure:

*Table 7. Merge Types*

<b>Data Structure</b>	<b>Merge Type</b>
IMap	<ul style="list-style-type: none"> <li>• <b>MergingEntry</b></li> <li>• <b>MergingCreationTime</b></li> <li>• <b>MergingHits</b></li> <li>• <b>MergingLastAccessTime</b></li> <li>• <b>MergingLastUpdateTime</b></li> <li>• <b>MergingTTL</b></li> <li>• <b>MergingMaxIdle</b></li> <li>• <b>MergingCosts</b></li> <li>• <b>MergingVersion</b></li> <li>• <b>MergingExpirationTime</b></li> <li>• <b>MergingLastStoredTime</b></li> </ul>
ICache	<ul style="list-style-type: none"> <li>• <b>MergingEntry</b></li> <li>• <b>MergingCreationTime</b></li> <li>• <b>MergingHits</b></li> <li>• <b>MergingLastAccessTime</b></li> <li>• <b>MergingLastUpdateTime</b></li> <li>• <b>MergingTTL</b></li> </ul>
ReplicatedMap	<ul style="list-style-type: none"> <li>• <b>MergingEntry</b></li> <li>• <b>MergingCreationTime</b></li> <li>• <b>MergingHits</b></li> <li>• <b>MergingLastAccessTime</b></li> <li>• <b>MergingLastUpdateTime</b></li> <li>• <b>MergingTTL</b></li> </ul>

Data Structure	Merge Type
MultiMap	<ul style="list-style-type: none"> <li>• MergingEntry</li> <li>• MergingCreationTime</li> <li>• MergingHits</li> <li>• MergingLastAccessTime</li> <li>• MergingLastUpdateTime</li> </ul>
IQueue, ISet, IList, Ringbuffer	<ul style="list-style-type: none"> <li>• MergingValue</li> </ul>
IAtomicLong, IAtomicReference	<ul style="list-style-type: none"> <li>• MergingValue</li> </ul>
CardinalityEstimator	<ul style="list-style-type: none"> <li>• MergingEntry</li> </ul>
ScheduledExecutorService	<ul style="list-style-type: none"> <li>• MergingEntry</li> </ul>

The following sections show various examples on how to implement merge type interfaces for all data structures, specific merge types or a specific data structure.

### Accessing Deserialized Values

`MergingValue.getValue()` and `MergingEntry.getKey()` always return the data in the in-memory format of the data structure. For some data structure like `IMap` this depends on your configuration. Other data structure like `ISet` or `IList` always use the `BINARY` in-memory format. So it is very likely, that you will receive a `Data` instance as key or value from those methods.

If you need the deserialized key or value, you have to call `MergingValue.getDeserializedValue()` or `MergingEntry.getDeserializedKey()`. The deserialization is done lazily on that method call, since it's quite expensive and should be avoided if the result is not needed. This will also require the deserialized classes to be on the classpath of the server. Otherwise a `ClassNotFoundException` will be thrown.

This is an example which checks if the (deserialized) value of the `mergingValue` or `existingValue` is an `Integer`. If so it will be merged, otherwise `null` is returned (which will remove the entry):

```

public class MergeIntegerValuesMergePolicy<V> implements SplitBrainMergePolicy<V,
MergingValue<V>> {

    @Override
    public V merge(MergingValue<V> mergingValue, MergingValue<V> existingValue) {
        Object mergingUserValue = mergingValue.getDeserializedValue();
        Object existingUserValue = existingValue == null ? null : existingValue
.getDeserializedValue();
        System.out.println("===== Merging..."
            + "\n    mergingValue: " + mergingUserValue
            + "\n    existingValue: " + existingUserValue
            + "\n    mergingValue class: " + mergingUserValue.getClass().getName()
            + "\n    existingValue class: " + (existingUserValue == null ? "null"
: existingUserValue.getClass().getName())
        );
        if (mergingUserValue instanceof Integer) {
            return mergingValue.getValue();
        }
        return null;
    }

    @Override
    public void writeData(ObjectDataOutput out) {
    }

    @Override
    public void readData(ObjectDataInput in) {
    }
}

```

For data structures like `ISet` or `ICollection` you need a merge policy, which supports collections:

```

public class MergeCollectionOfIntegerValuesMergePolicy
    implements SplitBrainMergePolicy<Collection<Object>, MergingValue<Collection
<Object>>> {

    @Override
    public Collection<Object> merge(MergingValue<Collection<Object>> mergingValue,
        MergingValue<Collection<Object>> existingValue) {
        Collection<Object> result = new ArrayList<Object>();
        for (Object value : mergingValue.<Collection<Object>>getDeserializedValue()) {
            if (value instanceof Integer) {
                result.add(value);
            }
        }
        if (existingValue != null) {
            for (Object value : existingValue.<Collection<Object>>
getDeserializedValue()) {
                if (value instanceof Integer) {
                    result.add(value);
                }
            }
        }
        return result;
    }

    @Override
    public void writeData(ObjectDataOutput out) {
    }

    @Override
    public void readData(ObjectDataInput in) {
    }
}

```

You can also combine both merge policies to support single values and collections. This merge policy is a bit more complex and less type safe, but can be configured on all data structures:

```

public class MergeIntegerValuesMergePolicy2<V, T extends MergingValue<V>> implements
SplitBrainMergePolicy<V, T> {

    @Override
    public V merge(T mergingValue, T existingValue) {
        if (mergingValue.getDeserializedValue() instanceof Integer) {
            return mergingValue.getValue();
        }
        if (existingValue != null && existingValue.getDeserializedValue() instanceof
Integer) {
            return existingValue.getValue();
        }
        if (mergingValue.getValue() instanceof Collection) {
            Collection<Object> result = new ArrayList<Object>();
            addIntegersToCollection(mergingValue, result);
            if (result.isEmpty() && existingValue != null) {
                addIntegersToCollection(existingValue, result);
            }
            return (V) result;
        }
        return null;
    }

    private void addIntegersToCollection(T mergingValue, Collection<Object> result) {
        for (Object value : mergingValue.<Collection<Object>>getDeserializedValue()) {
            if (value instanceof Integer) {
                result.add(value);
            }
        }
    }

    @Override
    public void writeData(ObjectDataOutput out) {
    }

    @Override
    public void readData(ObjectDataInput in) {
    }
}

```



Please have in mind that `existingValue` can be `null`, so a `null` check is mandatory before calling `existingValue.getValue()` or `existingValue.getDeserializedValue()`.



If you return `null` on a collection based data structure, the whole data structure will be removed. An empty collection works in the same way, so you don't have to check `Collection.isEmpty()` in your merge policy.



## Accessing Hazelcast UserContext

If you need access to external references in your merge policy, you can use the Hazelcast `UserContext` to get them injected. An example would be a database connection to check which value is stored in your database. To achieve this your merge policy needs to implement `HazelcastInstanceAware` and call `HazelcastInstance.getUserContext()`:

```

public class UserContextMergePolicy<V> implements SplitBrainMergePolicy<V,
MergingValue<V>>, HazelcastInstanceAware {

    public static final String TRUTH_PROVIDER_ID = "truthProvider";

    private transient TruthProvider truthProvider;

    @Override
    public V merge(MergingValue<V> mergingValue, MergingValue<V> existingValue) {
        Object mergingUserValue = mergingValue.getDeserializedValue();
        Object existingUserValue = existingValue == null ? null : existingValue
.getDeserializedValue();
        boolean isMergeable = truthProvider.isMergeable(mergingUserValue,
existingUserValue);
        System.out.println("===== Merging..."
            + "\n    mergingValue: " + mergingUserValue
            + "\n    existingValue: " + existingUserValue
            + "\n    isMergeable(): " + isMergeable
        );
        if (isMergeable) {
            return mergingValue.getValue();
        }
        return null;
    }

    @Override
    public void writeData(ObjectDataOutput out) {
    }

    @Override
    public void readData(ObjectDataInput in) {
    }

    @Override
    public void setHazelcastInstance(HazelcastInstance hazelcastInstance) {
        ConcurrentMap<String, Object> userContext = hazelcastInstance.getUserContext(
);
        truthProvider = (TruthProvider) userContext.get(TRUTH_PROVIDER_ID);
    }

    public interface TruthProvider {

        boolean isMergeable(Object mergingValue, Object existingValue);
    }
}

```

The `UserContext` can be setup like this:

```

MergePolicyConfig mergePolicyConfig = new MergePolicyConfig()
    .setPolicy(UserContextMergePolicy.class.getName());

MapConfig mapConfig = new MapConfig("default")
    .setMergePolicyConfig(mergePolicyConfig);

ConcurrentMap<String, Object> userContext = new ConcurrentHashMap<String, Object>();
userContext.put(TruthProvider.TRUTH_PROVIDER_ID, new ExampleTruthProvider());

Config config = new Config()
    .addMapConfig(mapConfig)
    .setUserContext(userContext);

Hazelcast.newHazelcastInstance(config);

```



The merge operations are executed on the partition threads. Database accesses are slow compared to in-memory operations. The `SplitBrainMergePolicy.merge()` method will be called for every key-value pair or every collection from your smaller cluster, which has a merge policy defined. So there can be millions of database accesses due to a merge policy, which implements this. Be aware that this can block your cluster for a long time or overload your database due to the high amount of queries.

Also the `com.hazelcast.core.LifecycleEvent.MERGED` will be thrown after a timeout (we don't wait forever for merge operations to continue). At the moment this timeout is 500 milliseconds per merged item or entry, but at least 5 seconds. If your database is slow, you might get the `LifecycleEvent` while there are still merge operations in progress.

### Merge Policies With Multiple Merge Types

You can also write a merge policy, which requires multiple merge types. This merge policy is supported by all data structures, which provide `MergingHits` and `MergingCreationTime`:

```

public class ComposedHitsAndCreationTimeMergePolicy<V, T extends MergingHits<V> &
MergingCreationTime<V>>
    implements SplitBrainMergePolicy<V, T> {

    @Override
    public V merge(T mergingValue, T existingValue) {
        if (existingValue == null) {
            return mergingValue.getValue();
        }
        System.out.println("===== Merging value " + mergingValue
.getDeserializedValue() + "...")
            + "\n    mergingValue creation time: " + mergingValue.getCreationTime
()
            + "\n    existingValue creation time: " + existingValue
.getCreationTime()
            + "\n    mergingValue hits: " + mergingValue.getHits()
            + "\n    existingValue hits: " + existingValue.getHits()
        );

        if (mergingValue.getCreationTime() < existingValue.getCreationTime()
            && mergingValue.getHits() > existingValue.getHits()) {
            return mergingValue.getValue();
        }
        return existingValue.getValue();
    }

    @Override
    public void writeData(ObjectDataOutput out) {
    }

    @Override
    public void readData(ObjectDataInput in) {
    }
}

```

If you configure this merge policy on a data structures, which does not provide these merge types, you will get an `InvalidConfigurationException` with a message like:

The merge policy `org.example.merge.ComposedHitsAndCreationTimeMergePolicy` can just be configured on data structures which provide the merging type `com.hazelcast.spi.merge.MergingHits`. See `SplitBrainMergingTypes` for supported merging types.

## Merge Policies For Specific Data Structures

It's also possible to restrict a merge policy to a specific data structure. This merge policy will only work on `IMap`:

```

public class MapEntryCostsMergePolicy implements SplitBrainMergePolicy<Data,
MapMergeTypes> {

    @Override
    public Data merge(MapMergeTypes mergingValue, MapMergeTypes existingValue) {
        if (existingValue == null) {
            return mergingValue.getValue();
        }
        System.out.println("===== Merging key " + mergingValue
.getDeserializedKey() + "...")
            + "\n    mergingValue costs: " + mergingValue.getCost()
            + "\n    existingValue costs: " + existingValue.getCost()
        );

        if (mergingValue.getCost() > existingValue.getCost()) {
            return mergingValue.getValue();
        }
        return existingValue.getValue();
    }

    @Override
    public void writeData(ObjectDataOutput out) {
    }

    @Override
    public void readData(ObjectDataInput in) {
    }
}

```

If you configure it on other data structures, you will get an `InvalidConfigurationException` with a message like:

```

The merge policy org.example.merge.MapEntryCostsMergePolicy
can just be configured on data structures which provide the merging type
com.hazelcast.spi.merge.SplitBrainMergeTypes$MapMergeTypes.
See SplitBrainMergingTypes for supported merging types.

```

This is another example for a merge policy, which will only work on the `IAtomicReference` and uses a named type parameter `T`:

```

public class AtomicReferenceMergeIntegerValuesMergePolicy implements
SplitBrainMergePolicy<Object, AtomicReferenceMergeTypes> {

    @Override
    public Object merge(AtomicReferenceMergeTypes mergingValue,
AtomicReferenceMergeTypes existingValue) {
        Object mergingUserValue = mergingValue.getDeserializedValue();
        Object existingUserValue = existingValue == null ? null : existingValue
.getDeserializedValue();
        System.out.println("==== Merging..."
            + "\n    mergingValue: " + mergingUserValue
            + "\n    existingValue: " + existingUserValue
            + "\n    mergingValue class: " + mergingUserValue.getClass().getName()
            + "\n    existingValue class: " + (existingUserValue == null ? "null"
: existingUserValue.getClass().getName())
        );
        if (mergingUserValue instanceof Integer) {
            return mergingValue.getValue();
        }
        return null;
    }

    @Override
    public void writeData(ObjectDataOutput out) {
    }

    @Override
    public void readData(ObjectDataInput in) {
    }
}

```

Although every data structure supports `MergingValue`, which is the only merge type of `AtomicReferenceMergeTypes`, this merge policy is restricted to `IAtomicReference` data structures:

The merge policy `org.example.merge.AtomicReferenceMergeIntegerValuesMergePolicy` can just be configured on data structures which provide the merging type `com.hazelcast.spi.merge.SplitBrainMergeTypes$AtomicReferenceMergeTypes`. See `SplitBrainMergingTypes` for supported merging types.

## Best Practices

Here are some best practices when implementing your own merge policy

- Only call `MergingValue.getDeserializedValue()` and `MergingEntry.getDeserializedKey()` when you really need the deserialized value to save costs (CPU and memory) and avoid `ClassNotFoundException`.
- If you want to return one of the given values (merging or existing), it's best to return `mergingValue.getValue()` or `existingValue.getValue()`, since they are already in the correct in-

memory format of the data structure. If you return a deserialized value, it might need to be serialized again, which are avoidable costs.

- Be careful with slow operations in the merge policy (like database accesses), since they will block your partition threads. Also the `LifeCycleEvent.MERGED` or `LifeCycleEvent.MERGE_FAILED` may be thrown too early, if the merge operations take too long to finish.

## Appendix A: System Properties

The table below lists the system properties with their descriptions in alphabetical order.



When you want to reconfigure a system property, you need to restart the members for which the property is modified.

Table 8. System Properties

Property Name	Default Value	Type	Description
<code>hazelcast.application.validation.token</code>		string	This property can be used to verify that Hazelcast members only join when their application level configuration is the same.
<code>hazelcast.backpressure.backoff.timeout.millis</code>	60000	int	Controls the maximum timeout in milliseconds to wait for an invocation space to be available. The value needs to be equal to or larger than 0.
<code>hazelcast.backpressure.enabled</code>	false	bool	Enable back pressure.
<code>hazelcast.backpressure.max.concurrent.invocations.per.partition</code>	100	int	The maximum number of concurrent invocations per partition.
<code>hazelcast.backpressure.syncwindow</code>	1000	string	Used when back pressure is enabled. The larger the sync window value, the less frequent a asynchronous backup is converted to a sync backup.
<code>hazelcast.cache.invalidation.batch.enabled</code>	true	bool	Specifies whether the cache invalidation event batch sending is enabled or not.
<code>hazelcast.cache.invalidation.batch.size</code>	100	int	Defines the maximum number of cache invalidation events to be drained and sent to the event listeners in a batch.
<code>hazelcast.cache.invalidation.batchfrequency.seconds</code>	5	int	Defines cache invalidation event batch sending frequency in seconds.
<code>hazelcast.client.endpoint.remove.delay.seconds</code>	60	int	Time, in seconds, after which the client connection is removed or the owner member of a client is removed from the cluster, in case of a client disconnection. Normally, the disconnection cleans all resources of a client, i.e., listeners are removed and locks/transactions are released. Using this property, the client has a window to connect back and prevent cleaning up its resources.

<code>hazelcast.clientengine.query.thread.count</code>		int	Number of threads to process query requests coming from the clients. Default count is the number of cores multiplied by 1.
<code>hazelcast.clientengine.thread.count</code>		int	Maximum number of threads to process non-partition-aware client requests, like <code>map.size()</code> , executor tasks, etc. Default count is the number of cores multiplied by 20.
<code>hazelcast.diagnostics.directory</code>	<code>user.dir</code>	string	Output directory of the diagnostic log files.  NOTE: For detailed information on the diagnostic tool, along with this and the following diagnostic related system properties, please refer to the <a href="#">Diagnostics section</a> .
<code>hazelcast.diagnostics.enabled</code>	false	bool	Specifies whether diagnostics tool is enabled or not for the cluster.
<code>hazelcast.diagnostics.filename.prefix</code>		string	Optional prefix for the diagnostics log file.
<code>hazelcast.diagnostics.invocation.sample.period.seconds</code>	0	long	Frequency of scanning all the pending invocations in seconds. 0 means the <code>Invocations</code> plugin for diagnostics tool is disabled.
<code>hazelcast.diagnostics.invocation.slow.threshold.seconds</code>	5	long	Threshold period, in seconds, that makes an invocation to be considered as slow.
<code>hazelcast.diagnostics.max.rolled.file.count</code>	10	int	Allowed count of diagnostic files within each roll.
<code>hazelcast.diagnostics.max.rolled.file.size.mb</code>	50	int	Size of each diagnostic file to be rolled.
<code>hazelcast.diagnostics.member-heartbeat.seconds</code>	10	long	Period for which the MemberHeartbeats plugin of the diagnostics tool runs. 0 means this plugin is disabled.
<code>hazelcast.diagnostics.member-heartbeat.max-deviation-percentage</code>	100	int	Maximum allowed deviation for a member-to-member heartbeats.
<code>hazelcast.diagnostics.memberinfo.period.second</code>	60	long	Frequency, in seconds, at which the cluster information is dumped to the diagnostics log file.
<code>hazelcast.diagnostics.metric.level</code>	Mandatory	string	Level of detail for the diagnostic tool.
<code>hazelcast.diagnostics.metrics.period.seconds</code>	60	long	Frequency, in seconds, at which the Metrics plugin dumps information to the diagnostics log file.
<code>hazelcast.diagnostics.metrics.level</code>	Mandatory	string	Level of detail for the Metrics plugin of the diagnostic tool.
<code>hazelcast.diagnostics.operation-heartbeat.seconds</code>	10	long	Period, in seconds, for which the OperationHeartbeats plugin of the diagnostics tool runs. 0 means this plugin is disabled.



<code>hazelcast.diagnostics.operation-heartbeat.max-deviation-percentage</code>	33	int	Maximum allowed deviation for a member-to-member operation heartbeats.
<code>hazelcast.diagnostics.pending.invocations.period.seconds</code>	0	long	Period, in seconds, for which the PendingInvocations plugin of the diagnostics tool runs. 0 means this plugin is disabled.
<code>hazelcast.diagnostics.slowoperations.period.seconds</code>	60	long	Period, in seconds, for which the SlowOperations plugin of the diagnostics tool runs. 0 means this plugin is disabled.
<code>hazelcast.diagnostics.storelatency.period.seconds</code>	0	long	Period, in seconds, for which the StoreLatency plugin of the diagnostics tool runs. 0 means this plugin is disabled.
<code>hazelcast.diagnostics.storelatency.reset.period.seconds</code>	0	long	Period, in seconds, for resetting the statistics for the StoreLatency plugin of the diagnostics tool.
<code>hazelcast.diagnostics.systemlog.enabled</code>	true	bool	Specifies whether the SystemLog plugin of the diagnostics tool is enabled or not.
<code>hazelcast.diagnostics.systemlog.partitions</code>	false	bool	Specifies whether the SystemLog plugin collects information about partition migrations.
<code>hazelcast.execution.service.taskscheduler.remove.oncancel</code>	false	bool	Controls whether the task scheduler removes tasks immediately upon cancellation. This is disabled by default, because it can cause severe delays on the other operations. By default all cancelled tasks will eventually get removed by the scheduler workers.
<code>hazelcast.client.max.no.heartbeat.seconds</code>	300	int	Time after which the member assumes the client is dead and closes its connections to the client.
<code>hazelcast.compatibility.3.6.client</code>	false	bool	When this property is true, if the server cannot determine the connected client version, it will assume that it has the version 3.6.x. This property is especially needed if you are using ICache (or JCache).
<code>hazelcast.connect.all.wait.seconds</code>	120	int	Timeout to connect all other cluster members when a member is joining to a cluster.
<code>hazelcast.connection.monitor.interval</code>	100	int	Minimum interval in milliseconds to consider a connection error as critical.
<code>hazelcast.connection.monitor.max.faults</code>	3	int	Maximum IO error count before disconnecting from a member.
<code>hazelcast.discovery.public.ip.enabled</code>	false	bool	Enable use of public IP address in member discovery with Discovery SPI. If you set this property to true in your source cluster, please make sure you have set the public addresses for your target members since they will be discovered using their public addresses. Otherwise, they cannot be discovered. Please see the <a href="#">Public Address section</a> .

<code>hazelcast.enterprise.license.key</code>	null	string	<a href="#">Hazelcast IMDG Enterprise</a> license key.
<code>hazelcast.event.queue.capacity</code>	1000000	int	Capacity of internal event queue.
<code>hazelcast.event.queue.timeout.millis</code>	250	int	Timeout to enqueue events to event queue.
<code>hazelcast.event.thread.count</code>	5	int	Number of event handler threads.
<code>hazelcast.graceful.shutdown.max.wait</code>	600	int	Maximum wait in seconds during graceful shutdown.
<code>hazelcast.http.healthcheck.enabled</code>	false	bool	Enable/disable Hazelcast's HTTP based health check implementation. When it is enabled, you can retrieve information about your cluster's health status (member state, cluster state, cluster size, etc.) by launching <a href="http://&lt;your member's host IP&gt;:5701/hazelcast/health">http://&lt;your member's host IP&gt;:5701/hazelcast/health</a> .
<code>hazelcast.health.monitoring.delay.seconds</code>	30	int	Health monitoring logging interval in seconds. NOTE: For detailed information on the health monitoring tool, along with this and the following health monitoring related system properties, please refer to the <a href="#">Health Check and Monitoring section</a> .
<code>hazelcast.health.monitoring.level</code>	SILENT	string	Health monitoring log level. When <b>SILENT</b> , logs are printed only when values exceed some predefined threshold. When <b>NOISY</b> , logs are always printed periodically. Set <b>OFF</b> to turn off completely.
<code>hazelcast.health.monitoring.threshold.cpu.percentage</code>	70	int	When the health monitoring level is <b>SILENT</b> , logs are printed only when the CPU usage exceeds this threshold.
<code>hazelcast.health.monitoring.threshold.memory.percentage</code>	70	int	When the health monitoring level is <b>SILENT</b> , logs are printed only when the memory usage exceeds this threshold.
<code>hazelcast.heartbeat.interval.seconds</code>	5	int	Heartbeat send interval in seconds.
<code>hazelcast.hidensity.check.freememory</code>	true	bool	If enabled and is able to fetch memory statistics via Java's <a href="#">OperatingSystemMXBean</a> , it checks whether there is enough free physical memory for the requested number of bytes. If the free memory checker is disabled (false), acts as if the check is succeeded.
<code>hazelcast.icmp.echo.fail.fast.on.startup</code>	true	bool	Specifies whether ICMP Echo Request mode for ping detector is enforced. If OS is not supported, or not configured correctly, as explained in <a href="#">Requirements and Linux/Unix Configuration</a> , Hazelcast will fail to start.
<code>hazelcast.icmp.enabled</code>	false	bool	Specifies whether ICMP ping is enabled or not.
<code>hazelcast.icmp.interval</code>	1000	int	Interval between ping attempts in milliseconds. Default and minimum allowed value is 1 second.
<code>hazelcast.icmp.max.attempts</code>	3	int	Maximum ping attempts before suspecting a member.
<code>hazelcast.icmp.parallel.mode</code>	true	bool	Specifies whether <a href="#">Ping Failure Detector</a> will work in parallel with the other detectors.

<code>hazelcast.icmp.timeout</code>	1000	int	ICMP timeout in milliseconds. This cannot be more than the value of <code>hazelcast.icmp.interval</code> property; it should always be smaller.
<code>hazelcast.icmp.ttl</code>	0	int	ICMP TTL (maximum numbers of hops to try).
<code>hazelcast.index.copy.behavior</code>	COPY_ON_READ	string	Defines the behavior for index copying on index read/write. Please refer to the <a href="#">Copying Indexes section</a> .
<code>hazelcast.initial.min.cluster.size</code>	0	int	Initial expected cluster size to wait before member to start completely.
<code>hazelcast.initial.wait.seconds</code>	0	int	Initial time in seconds to wait before member to start completely.
<code>hazelcast.internal.map.expiration.cleanup.operation.count</code>	3	int	This is a property which is used internally and subject to change in the future releases.
<code>hazelcast.internal.map.expiration.cleanup.percentage</code>	10	int	This is a property which is used internally and subject to change in the future releases.
<code>hazelcast.internal.map.expiration.task.period.seconds</code>	5	int	This is a property which is used internally and subject to change in the future releases.
<code>hazelcast.invalidation.max.tolerated.miss.count</code>	10	int	If missed invalidation count is bigger than this value, relevant cached data will be made unreachable.
<code>hazelcast.invalidation.reconciliation.interval.seconds</code>	60	int	Period for which the cluster members are scanned to compare generated invalidation events with the received ones from Near Cache.
<code>hazelcast.io.balancer.interval.seconds</code>	20	int	Interval in seconds between IOBalancer executions.
<code>hazelcast.io.input.thread.count</code>	3	int	Number of socket input threads.
<code>hazelcast.io.output.thread.count</code>	3	int	Number of socket output threads.
<code>hazelcast.io.thread.count</code>	3	int	Number of threads performing socket input and socket output. If, for example, the default value (3) is used, it means there are 3 threads performing input and 3 threads performing output (6 threads in total).
<code>hazelcast.jcache.provider.type</code>		string	Type of the JCache provider. Values can be <code>client</code> or <code>server</code> .
<code>hazelcast.jmx</code>	false	bool	Enable <a href="#">JMX</a> agent.
<code>hazelcast.legacy.memberlist.format.enabled</code>	false	bool	Enables the legacy (for the releases before Hazelcast 3.9) member list format which is printed in the logs. The new format is introduced starting with Hazelcast 3.9 and includes member list version. Any change in the cluster, such as a member leaving or joining, will increment the member list version. Please see the <a href="#">Starting the Member and Client section</a> .

<code>hazelcast.local.localAddress</code>		string	It is an overrider property for the default server socket listener's IP address. If this property is set, then this is the address where the server socket is bound to.
<code>hazelcast.local.publicAddress</code>		string	It is an overrider property for the default public address to be advertised to other cluster members and clients.
<code>hazelcast.lock.max.lease.time.seconds</code>	Long.MAX_VALUE	long	All locks which are acquired without an explicit lease time use this value (in seconds) as the lease time. When you want to set an explicit lease time for your locks, you cannot set it to a longer time than this value.
<code>hazelcast.logging.type</code>	jdk	enum	Name of <a href="#">logging</a> framework type to send logging events.
<code>hazelcast.managementcenter.home</code>	managementcenter	string	Folder where Management Center data files are stored (license information, time travel information, etc.).
<code>hazelcast.map.entry.filtering.natural.event.types</code>	false	bool	Notify <a href="#">entry listeners with predicates</a> on map entry updates with events that match entry, update or exit from predicate value space.
<code>hazelcast.map.expiry.delay.seconds</code>	10	int	Useful to deal with some possible edge cases. For example, when using EntryProcessor, without this delay, you may see an EntryProcessor running on owner partition found a key but EntryBackupProcessor did not find it on backup. As a result of this, when backup promotes to owner, you will end up an unprocessed key.
<code>hazelcast.map.invalidation.batchfrequency.seconds</code>	10	int	If the collected invalidations do not reach the configured batch size, a background process sends them at this interval.
<code>hazelcast.map.invalidation.batch.enabled</code>	true	bool	Enable or disable batching. When it is set to <code>false</code> , all invalidations are sent immediately.
<code>hazelcast.map.invalidation.batch.size</code>	100	int	Maximum number of invalidations in a batch.
<code>hazelcast.map.load.chunk.size</code>	1000	int	Maximum size of the key batch sent to the partition owners for value loading and the maximum size of a key batch for which values are loaded in a single partition.
<code>hazelcast.map.replica.wait.seconds.for.scheduled.tasks</code>	10	int	Scheduler delay for map tasks those will be executed on backup members.
<code>hazelcast.map.write.behind.queue.capacity</code>	50000	string	Maximum write-behind queue capacity per member. It is the total of all write-behind queue sizes in a member including backups. Its maximum value is <code>Integer.MAX_VALUE</code> . The value of this property is taken into account only if the <code>write-coalescing</code> element of the Map Store configuration is <code>false</code> . Please refer to <a href="#">here</a> for the description of the <code>write-coalescing</code> element.
<code>hazelcast.master.confirmation.interval.seconds</code>	30	int	Interval at which members send master confirmation. This property is deprecated as of this (3.10) release.

<code>hazelcast.mastership.claim.member.list.version.increment</code>	25	int	Hazelcast master member (oldest in the cluster) increments the member list version for each joining member. Then, these member list versions are used to identify the joined members with unique integers. For this algorithm to work under network partitioning scenarios, without generating duplicate member list join versions for different members, a mastership-claiming member increments the member list version as specified by this parameter, multiplied by its position in the member list. The value of the parameter must be bigger than the cluster size.
<code>hazelcast.mastership.claim.timeout.seconds</code>	120	int	Timeout which defines when master candidate gives up waiting for response to its mastership claim. After timeout happens, non-responding member will be removed from the member list.
<code>hazelcast.max.join.merge.target.seconds</code>	20	int	Split-brain merge timeout for a specific target.
<code>hazelcast.max.join.seconds</code>	300	int	Join timeout, maximum time to try to join before giving.
<code>hazelcast.max.no.heartbeat.seconds</code>	60	int	Maximum timeout of heartbeat in seconds for a member to assume it is dead.  CAUTION: Setting this value too low may cause members to be evicted from the cluster when they are under heavy load: they will be unable to send heartbeat operations in time, so other members will assume that it is dead.
<code>hazelcast.max.no.master.confirmation.seconds</code>	150	int	Max timeout of master confirmation from other members. This property is deprecated as of this (3.10) release.
<code>hazelcast.max.wait.seconds.before.join</code>	20	int	Maximum wait time before join operation.
<code>hazelcast.mc.max.visible.slow.operations.count</code>	10	int	Management Center maximum visible slow operations count.
<code>hazelcast.mc.url.change.enabled</code>	true	bool	Management Center changing server url is enabled.
<code>hazelcast.member.list.publish.interval.seconds</code>	60	int	Interval at which master member publishes a member list.
<code>hazelcast.memcache.enabled</code>	false	bool	Enable <a href="#">Memcache</a> client request listener service.
<code>hazelcast.merge.first.run.delay.seconds</code>	300	int	Initial run delay of <a href="#">split-brain/merge process</a> in seconds.
<code>hazelcast.merge.next.run.delay.seconds</code>	120	int	Run interval of <a href="#">split-brain/merge process</a> in seconds.
<code>hazelcast.migration.min.delay.on.member.removed.seconds</code>	5	int	Minimum delay (in seconds) between detection of a member that has left and start of the rebalancing process.

<code>hazelcast.multicast.group</code>	224.2.2.3	string	IP address of a multicast group. If not set, configuration is read from the default Hazelcast configuration, which has the value 224.2.2.3.
<code>hazelcast.nio.tcp.spoofting.checks</code>	false	bool	Controls whether more strict checks upon BIND requests towards a cluster member are applied. The checks mainly validate the remote BIND request against the remote address as found in the socket. By default they are disabled, to avoid connectivity issues when deployed under NAT'ed infrastructure.
<code>hazelcast.operation.backup.timeout.millis</code>	5000	int	Maximum time a caller to wait for backup responses of an operation. After this timeout, operation response will be returned to the caller even no backup response is received.
<code>hazelcast.operation.fail.on.indeterminate.state</code>	false	bool	When enabled, an operation fails with <code>IndeterminateOperationStateException</code> , if it does not receive backup acks in time with respect to backup configuration of its data structure, or the member which owns primary replica of the target partition leaves the cluster.
<code>hazelcast.operation.call.timeout.millis</code>	60000	int	Timeout to wait for a response when a remote call is sent, in milliseconds.
<code>hazelcast.operation.generic.thread.count</code>	-1	int	Number of generic operation handler threads. -1 means CPU core count / 2.
<code>hazelcast.operation.responsequeue.idlestrategy</code>	block	string	Specifies whether the response thread for internal operations at the member side will be blocked or not. If you use <code>block</code> (the default value) the thread will be blocked and need to be notified which can cause a reduction in the performance. If you use <code>backoff</code> there will be no blocking. By enabling the backoff mode and depending on your use case, you can get a 5-10% performance improvement. However, keep in mind that this will increase CPU utilization. We recommend you to use backoff with care and if you have a tool for measuring your cluster's performance.
<code>hazelcast.operation.thread.count</code>	-1	int	Number of partition based operation handler threads. -1 means CPU core count.
<code>hazelcast.partition.backup.sync.interval</code>	30	int	Interval for syncing backup replicas in seconds.
<code>hazelcast.partition.count</code>	271	int	Total partition count.
<code>hazelcast.partition.max.parallel.replications</code>	5	int	Maximum number of parallel partition backup replication operations per member. When a partition backup ownership changes or a backup inconsistency is detected, the members start to sync their backup partitions. This parameter limits the maximum running replication operations in parallel.

<code>hazelcast.partition.migration.fragments.enabled</code>	true	bool	When enabled, which is the default behavior, partitions are migrated/replicated in small fragments instead of one big chunk. Migrating partitions in fragments reduces pressure on the memory and network, since smaller packets are created in the memory and sent through the network. Note that it can increase the migration time to complete.
<code>hazelcast.partition.migration.interval</code>	0	int	Interval to run partition migration tasks in seconds.
<code>hazelcast.partition.migration.stale.read.disabled</code>	false	bool	Hazelcast allows read operations to be performed while a partition is being migrated. This can lead to stale reads for some scenarios. You can disable stale read operations by setting this system property's value to "true". Its default value is "false", meaning that stale reads are allowed.
<code>hazelcast.partition.migration.timeout</code>	300	int	Timeout for partition migration tasks in seconds.
<code>hazelcast.partition.table.send.interval</code>	15	int	Interval for publishing partition table periodically to all cluster members in seconds.
<code>hazelcast.partitioning.strategy.class</code>	null	string	Class name implementing <code>com.hazelcast.core.PartitioningStrategy</code> , which defines key to partition mapping.
<code>hazelcast.performance.monitor.max.rolled.file.count</code>	10	int	The PerformanceMonitor uses a rolling file approach to prevent eating too much disk space. This property sets the maximum number of rolling files to keep on disk.
<code>hazelcast.performance.monitor.max.rolled.file.size.mb</code>	10	int	The performance monitor uses a rolling file approach to prevent eating too much disk space. This property sets the maximum size in MB for a single file. Every HazelcastInstance gets its own history of log files.
<code>hazelcast.performance.monitoring.enabled</code>		bool	Enable the performance monitor, a tool which allows you to see internal performance metrics. These metrics are written to a dedicated log file.
<code>hazelcast.performance.monitor.delay.seconds</code>		int	The period between successive entries in the performance monitor's log file.
<code>hazelcast.prefer.ipv4.stack</code>	true	bool	Prefer IPv4 network interface when picking a local address.
<code>hazelcast.query.max.local.partition.limit.for.precheck</code>	3	int	Maximum value of local partitions to trigger local pre-check for TruePredicate query operations on maps.
<code>hazelcast.query.optimizer.type</code>	RULES	String	Type of the query optimizer. For optimizations based on static rules, set the value to <b>RULES</b> . To disable the optimization, set the value to <b>NONE</b> .

<code>hazelcast.query.predicate.parallel.evaluation</code>	false	bool	Each Hazelcast member evaluates query predicates using a single thread by default. In most cases, the overhead of inter-thread communications overweight can benefit from parallel execution. When you have a large dataset and/or slow predicate, you may benefit from parallel predicate evaluations. Set to <code>true</code> if you are using slow predicates or have > 100,000s entries per member.
<code>hazelcast.query.result.size.limit</code>	-1	int	Result size limit for query operations on maps. This value defines the maximum number of returned elements for a single query result. If a query exceeds this number of elements, a <code>QueryResultSizeExceededException</code> is thrown. Its default value is -1, meaning it is disabled.
<code>hazelcast.rest.enabled</code>	false	bool	Enable <a href="#">REST</a> client request listener service.
<code>hazelcast.security.permissions.operation.on-join</code>	RECEIVE	bool	It is used to specify whether a new member joining to a cluster will apply the <a href="#">client permissions</a> stored in its own configuration and send them to the cluster, or use the ones configured in the cluster. Its default value is RECEIVE, i.e., the joining member uses the client permissions defined in the cluster. Available other values are <code>SEND</code> and <code>NONE</code> . See the <a href="#">Handling Permissions When a New Member Joins</a> section.
<code>hazelcast.shutdownhook.enabled</code>	true	bool	Enable Hazelcast shutdownhook thread. When this is enabled, this thread terminates the Hazelcast instance without waiting to shutdown gracefully.
<code>hazelcast.shutdownhook.policy</code>	TERMINATE	string	Specifies the behavior when JVM is exiting while the Hazelcast instance is still running. It has two values: <code>TERMINATE</code> and <code>GRACEFUL</code> . The former one terminates the Hazelcast instance immediately. The latter, <code>GRACEFUL</code> , initiates the graceful shutdown which can significantly slow down the JVM exit process, but it tries to retain data safety. Note that you should always shutdown Hazelcast explicitly via using the method <code>HazelcastInstance.shutdown()</code> . It's not recommended to rely on the shutdown hook, this is a last-effort measure.
<code>hazelcast.slow.operation.detector.enabled</code>	true	bool	Enables/disables the <a href="#">SlowOperationDetector</a> .
<code>hazelcast.slow.operation.detector.log.purge.interval.seconds</code>	300	int	Purge interval for slow operation logs.
<code>hazelcast.slow.operation.detector.log.retention.seconds</code>	3600	int	Defines the retention time of invocations in slow operation logs. If an invocation is older than this value, it will be purged from the log to prevent unlimited memory usage. When all invocations are purged from a log, the log itself will be deleted.



<code>hazelcast.slow.operation.detector.stacktrace.logging.enabled</code>	false	bool	Defines if the stacktraces of slow operations are logged in the log file. Stack traces are always reported to the Management Center, but by default, they are not printed to keep the log size small.
<code>hazelcast.slow.operation.detector.threshold.millis</code>	10000	int	Defines a threshold above which a running operation in <code>OperationService</code> is considered to be slow. These operations log a warning and are shown in the Management Center with detailed information, e.g., stacktrace.
<code>hazelcast.socket.bind.any</code>	true	bool	Bind both server-socket and client-sockets to any local interface.
<code>hazelcast.socket.buffer.direct</code>	false	bool	Specifies whether the byte buffers used in the socket should be a direct byte buffer ( <code>true</code> ) or a regular one ( <code>false</code> ). When it is set to <code>true</code> , Hazelcast internally uses the method <code>ByteBuffer.allocateDirect</code> (instead of <code>ByteBuffer.allocate</code> ) which makes use of the off-heap and may skip the memory copying when performing socket I/O operations. See <a href="#">here</a> for more information.
<code>hazelcast.socket.client.bind</code>	true	bool	Bind client socket to an interface when connecting to a remote server socket. When set to <code>false</code> , client socket is not bound to any interface.
<code>hazelcast.socket.client.bind.any</code>	true	bool	Bind client-sockets to any local interface. If not set, <code>hazelcast.socket.bind.any</code> will be used as default.
<code>hazelcast.socket.client.receive.buffer.size</code>	-1	int	Hazelcast creates all connections with receive buffer size set according to the <code>hazelcast.socket.receive.buffer.size</code> . When it detects a connection opened by a client, then it adjusts the receive buffer size according to this property. It is in kilobytes and its default value is -1.
<code>hazelcast.socket.client.send.buffer.size</code>	-1	int	Hazelcast creates all connections with send buffer size set according to the <code>hazelcast.socket.send.buffer.size</code> . When it detects a connection opened by a client, then it adjusts the send buffer size according to this property. It is in kilobytes and its default value is -1.
<code>hazelcast.socket.connect.timeout.seconds</code>	0	int	Socket connection timeout in seconds. <code>Socket.connect()</code> will be blocked until either connection is established or connection is refused or this timeout passes. Default is 0, means infinite.
<code>hazelcast.socket.keep.alive</code>	true	bool	Socket set keep alive ( <code>SO_KEEPALIVE</code> ).
<code>hazelcast.socket.linger.seconds</code>	0	int	Set socket <code>SO_LINGER</code> option.
<code>hazelcast.socket.no.delay</code>	true	bool	Socket set TCP no delay.
<code>hazelcast.socket.receive.buffer.size</code>	128	int	Socket receive buffer ( <code>SO_RCVBUF</code> ) size in KB. If you have a very fast network, e.g., 10gbit) and/or you have large entries, then you may benefit from increasing sender/receiver buffer sizes. Use this property and the next one below tune the size.

<code>hazelcast.socket.send.buffer.size</code>	128	int	Socket send buffer ( <code>SO_SNDBUF</code> ) size in KB.
<code>hazelcast.socket.server.bind.any</code>	true	bool	Bind server-socket to any local interface. If not set, <code>hazelcast.socket.bind.any</code> will be used as default.
<code>hazelcast.tcp.join.port.try.count</code>	3	int	The number of incremental ports, starting with the port number defined in the network configuration, that will be used to connect to a host (which is defined without a port in TCP/IP member list while a member is searching for a cluster).
<code>hazelcast.unsafe.mode</code>	auto	string	"auto" (the default value) automatically detects whether the usage of <code>Unsafe</code> is suitable for a given platform. "disabled" explicitly disables the <code>Unsafe</code> usage in your platform. "enforced" enforces the usage of <code>Unsafe</code> even if your platform does not support it. This property can only be set by passing a JVM-wide system property.
<code>hazelcast.phone.home.enabled</code>	true	bool	Enable or disable the sending of phone home data to Hazelcast's phone home server.
<code>hazelcast.wait.seconds.before.join</code>	5	int	Wait time before join operation.
<code>hazelcast.wan.map.useDeleteWhenProcessingRemoveEvents</code>	false	bool	Configures WAN replication for <code>IMap</code> on the PASSIVE cluster to remove entries using delete instead of remove and when using <code>com.hazelcast.enterprise.wan.replication.WanBatchReplication</code> as an endpoint implementation. The member which receives the event batch in the PASSIVE cluster dispatches WAN events to the partition owners as map merge and remove operations. When using remove operations, the old entry value is sent from the partition owner to the caller even though the caller does not use the old value. This can also lead to issues if the PASSIVE cluster does not contain the class definition for the entry value as the value will try to get deserialized, causing <code>ClassNotFoundException</code> 's. You can switch to using map remove instead on the PASSIVE cluster with this property. This will both save bandwidth and avoid the exception.

## Appendix B: Common Exception Types

You may see the following exceptions in any Hazelcast operation when the following situations occur:

- `HazelcastInstanceNotActiveException`: Thrown when `HazelcastInstance` is not active (already shutdown or being shutdown) during an invocation.
- `HazelcastOverloadException`: Thrown when the system will not handle any more load due to an overload. This exception is thrown when back pressure is enabled.
- `DistributedObjectDestroyedException`: Thrown when an already destroyed `DistributedObject` (`IMap`, `IQueue`, etc.) is accessed or when a method is called over a destroyed `DistributedObject`.
- `MemberLeftException`: Thrown when a member leaves during an invocation or execution.

Hazelcast also throws the following exceptions in the cases of overall system problems such as networking issues and long pauses:

- **PartitionMigratingException**: Thrown when an operation is executed on a partition, but that partition is currently being moved.
- **TargetNotMemberException**: Thrown when an operation is sent to a machine that is not a member of the cluster.
- **CallerNotMemberException**: Thrown when an operation was sent by a machine which is not a member in the cluster when the operation is executed.
- **WrongTargetException**: Thrown when an operation is executed on the wrong machine, usually because the partition that operation belongs to has been moved to some other member.

## Appendix C: License Questions

Hazelcast is distributed using the [Apache License 2](#), therefore permissions are granted to use, reproduce and distribute it along with any kind of open source and closed source applications.

Hazelcast IMDG Enterprise is a commercial product of Hazelcast, Inc. and is distributed under a commercial license that must be acquired before using it in any type of released software. Feel free to contact [Hazelcast sales department](#) for more information on commercial offers.

Depending on the used feature-set, Hazelcast has certain runtime dependencies which might have different licenses. Following are dependencies and their respective licenses.

### C.1. Embedded Dependencies

Embedded dependencies are merged (shaded) with the Hazelcast codebase at compile-time. These dependencies become an integral part of the Hazelcast distribution.

For license files of embedded dependencies, please see the [license](#) directory of the Hazelcast distribution, available at our [download page](#).

#### **minimal-json:**

minimal-json is a JSON parsing and generation library which is a part of the Hazelcast distribution. It is used for communication between the Hazelcast cluster and the Management Center.

minimal-json is distributed under the [MIT license](#) and offers the same rights to add, use, modify and distribute the source code as the Apache License 2.0 that Hazelcast uses. However, some other restrictions might apply.

### C.2. Runtime Dependencies

Depending on the used features, additional dependencies might be added to the dependency set. Those runtime dependencies might have other licenses. See the following list of additional runtime dependencies.

### **Spring Framework:**

Hazelcast offers a tight integration into the Spring Framework. Hazelcast can be configured and controlled using Spring.

The Spring Framework is distributed under the terms of the [Apache License 2](#) and therefore it is fully compatible with Hazelcast.

### **Hibernate:**

Hazelcast integrates itself into Hibernate as a second-level cache provider.

Hibernate is distributed under the terms of the [Lesser General Public License 2.1](#), also known as LGPL. Please read carefully the terms of the LGPL since restrictions might apply.

### **Apache Tomcat:**

Hazelcast IMDG Enterprise offers native integration into Apache Tomcat for web session clustering.

Apache Tomcat is distributed under the terms of the [Apache License 2](#) and therefore fully compatible with Hazelcast.

### **Eclipse Jetty:**

Hazelcast IMDG Enterprise offers native integration into Jetty for web session clustering.

Jetty is distributed with a dual licensing strategy. It is licensed under the terms of the [Apache License 2](#) and under the [Eclipse Public License v1.0](#), also known as EPL. Due to the Apache License, it is fully compatible with Hazelcast.

### **JCache API (JSR 107):**

Hazelcast offers a native implementation for JCache (JSR 107), which has a runtime dependency to the JCache API.

The JCache API is distributed under the terms of the so called [Specification License](#). Please read carefully the terms of this license since restrictions might apply.

### **Boost C++ Libraries:**

Hazelcast IMDG Enterprise offers a native C++ client, which has a link-time dependency to the Boost C++ Libraries.

The Boost Libraries are distributed under the terms of the [Boost Software License](#)), which is very similar to the MIT or BSD license. Please read carefully the terms of this license since restrictions might apply.

## **Appendix D: Frequently Asked Questions**

---

**Why 271 as the default partition count?**

---

The partition count of 271, being a prime number, is a good choice because it will be distributed to the members almost evenly. For a small to medium sized cluster, the count of 271 gives an almost even partition distribution and optimal-sized partitions. As your cluster becomes bigger, you should make this count bigger to have evenly distributed partitions.

---

### Is Hazelcast thread safe?

Yes. All Hazelcast data structures are thread safe.

---

### How do members discover each other?

When a member is started in a cluster, it will dynamically and automatically be discovered. The following are the types of discovery:

- Discovery by TCP/IP: the first member created in the cluster (leader) will form a list of IP addresses of other joining members and will send this list to these members so the members will know each other.
- Discovery at clouds: Hazelcast supports discovery at cloud platforms such as jclouds based environments, Azure, Consul and PCF.
- Multicast discovery: members in a cluster discover each other by multicast, by default. It is not recommended for production since UDP is often blocked in production environments and other discovery mechanisms are more definite

Once members are discovered, all the communication between them will be via TCP/IP.



Please refer to the [Discovery Mechanisms section](#) for detailed information.

---

### What happens when a member goes down?

Once a member is gone (crashes), the following happens since data in each member has a backup in other members.

- First, the backups in other members are restored.
- Then, data from these restored backups are recovered.
- And finally, new backups for these recovered data are formed.

So eventually, availability of the data is maintained.

---

### How do I test the connectivity?

If you notice that there is a problem with a member joining a cluster, you may want to perform a connectivity test between the member to be joined and a member from the cluster. You can use the `iperf` tool for this purpose. For example, you can execute the below command on one member (i.e.

listening on port 5701).

```
iperf -s -p 5701
```

And you can execute the below command on the other member.

```
iperf -c <IP address> -d -p 5701
```

The output should include connection information, such as the IP addresses, transfer speed and bandwidth. Otherwise, if the output says **No route to host**, it means a network connection problem exists.

---

### How do I choose keys properly?

When you store a key and value in a distributed Map, Hazelcast serializes the key and value and stores the byte array version of them in local ConcurrentHashMaps. These ConcurrentHashMaps use `equals` and `hashCode` methods of byte array version of your key. It does not take into account the actual `equals` and `hashCode` implementations of your objects. So it is important that you choose your keys in a proper way.

Implementing `equals` and `hashCode` is not enough, it is also important that the object is always serialized into the same byte array. All primitive types like String, Long, Integer, etc. are good candidates for keys to be used in Hazelcast. An unsorted Set is an example of a very bad candidate because Java Serialization may serialize the same unsorted set in two different byte arrays.

---

### How do I reflect value modifications?

Hazelcast always return a clone copy of a value. Modifying the returned value does not change the actual value in the map (or multimap, list, set). You should put the modified value back to make changes visible to all members.

```
V value = map.get( key );  
value.updateSomeProperty();  
map.put( key, value );
```

Collections which return values of methods (such as `IMap.keySet`, `IMap.values`, `IMap.entrySet`, `MultiMap.get`, `MultiMap.remove`, `IMap.keySet`, `IMap.values`) contain cloned values. These collections are NOT backed up by related Hazelcast objects. Therefore, changes to them are **NOT** reflected in the originals and vice-versa.

---

### How do I test my Hazelcast cluster?

Hazelcast allows you to create more than one instance on the same JVM. Each member is called `HazelcastInstance` and each will have its own configuration, socket and threads, so you can treat them as totally separate instances.

This enables you to write and to run cluster unit tests on a single JVM. Because you can use this feature for creating separate members different applications running on the same JVM (imagine running multiple web applications on the same JVM), you can also use this feature for testing your Hazelcast cluster.

Let's say you want to test if two members have the same size of a map.

```
@Test
public void testTwoMemberMapSizes() {
    // start the first member
    HazelcastInstance h1 = Hazelcast.newHazelcastInstance();
    // get the map and put 1000 entries
    Map map1 = h1.getMap( "testmap" );
    for ( int i = 0; i < 1000; i++ ) {
        map1.put( i, "value" + i );
    }
    // check the map size
    assertEquals( 1000, map1.size() );
    // start the second member
    HazelcastInstance h2 = Hazelcast.newHazelcastInstance();
    // get the same map from the second member
    Map map2 = h2.getMap( "testmap" );
    // check the size of map2
    assertEquals( 1000, map2.size() );
    // check the size of map1 again
    assertEquals( 1000, map1.size() );
}
```

In the test above, everything happens in the same thread. When developing a multi-threaded test, you need to carefully handle coordination of the thread executions. It is highly recommended that you use `CountDownLatch` for thread coordination (you can certainly use other ways). Here is an example where we need to listen for messages and make sure that we got these messages.

```

@Test
public void testTopic() {
    // start two member cluster
    HazelcastInstance h1 = Hazelcast.newHazelcastInstance();
    HazelcastInstance h2 = Hazelcast.newHazelcastInstance();
    String topicName = "TestMessages";
    // get a topic from the first member and add a messageListener
    ITopic<String> topic1 = h1.getTopic( topicName );
    final CountdownLatch latch1 = new CountdownLatch( 1 );
    topic1.addMessageListener( new MessageListener() {
        public void onMessage( Object msg ) {
            assertEquals( "Test1", msg );
            latch1.countDown();
        }
    });
    // get a topic from the second member and add a messageListener
    ITopic<String> topic2 = h2.getTopic(topicName);
    final CountdownLatch latch2 = new CountdownLatch( 2 );
    topic2.addMessageListener( new MessageListener() {
        public void onMessage( Object msg ) {
            assertEquals( "Test1", msg );
            latch2.countDown();
        }
    } );
    // publish the first message, both should receive this
    topic1.publish( "Test1" );
    // shutdown the first member
    h1.shutdown();
    // publish the second message, second member's topic should receive this
    topic2.publish( "Test1" );
    try {
        // assert that the first member's topic got the message
        assertTrue( latch1.await( 5, TimeUnit.SECONDS ) );
        // assert that the second members' topic got two messages
        assertTrue( latch2.await( 5, TimeUnit.SECONDS ) );
    } catch ( InterruptedException ignored ) {
    }
}

```

You can start Hazelcast members with different configurations. Remember to call `Hazelcast.shutdownAll()` after each test case to make sure that there is no other running member left from the previous tests.

```

@After
public void cleanup() throws Exception {
    Hazelcast.shutdownAll();
}

```



For more information please [check our existing tests](#).

---

### **Does Hazelcast support hundreds of members?**

Yes. Hazelcast performed a successful test on Amazon EC2 with 200 members.

---

### **Does Hazelcast support thousands of clients?**

Yes. However, there are some points you should consider. The environment should be LAN with a high stability and the network speed should be 10 Gbps or higher. If the number of members is high, the client type should be selected as Unisocket, not Smart Client. In the case of Smart Clients, since each client will open a connection to the members, these members should be powerful enough (for example, more cores) to handle hundreds or thousands of connections and client requests. Also, you should consider using Near Caches in clients to lower the network traffic. And you should use the Hazelcast releases with the NIO implementation (which starts with Hazelcast 3.2).

Also, you should configure the clients attentively. Please refer to the [Clients section](#) section for configuration notes.

---

### **Difference between Lite Member and Smart Client?**

Lite member supports task execution (distributed executor service), smart client does not. Also, Lite Member is highly coupled with cluster, smart client is not. Starting with Hazelcast 3.9, you can also promote lite members to data members. Please refer to the [Lite Members section](#) for more information.

---

### **How do you give support?**

We have two support services: community and commercial support. Community support is provided through our [Mail Group](#) and [StackOverflow](#) web site. For information on support subscriptions, please see [Hazelcast.com](#).

---

### **Does Hazelcast persist?**

No. However, Hazelcast provides [MapStore](#) and [MapLoader](#) interfaces. For example, when you implement the [MapStore](#) interface, Hazelcast calls your store and load methods whenever needed.

---

### **Can I use Hazelcast in a single server?**

Yes. But please note that Hazelcast's main design focus is multi-member clusters to be used as a distribution platform.

---

---

## How can I monitor Hazelcast?

[Hazelcast Management Center](#) is what you use to monitor and manage the members running Hazelcast. In addition to monitoring the overall state of a cluster, you can analyze and browse data structures in detail, you can update map configurations and you can take thread dumps from members.

You can also use Hazelcast's HTTP based health check implementation and health monitoring utility. Please see the [Health Check and Monitoring section](#). There is also a [diagnostocs tool](#) where you can see detailed logs enhanced with diagnostic plugins.

Moreover, JMX monitoring is also provided. Please see the [Monitoring with JMX section](#) for details.

---

## How can I see debug level logs?

By changing the log level to "Debug". Below are sample lines for **log4j** logging framework. Please see the [Logging Configuration section](#) to learn how to set logging types.

First, set the logging type as follows.

```
String location = "log4j.configuration";
String logging = "hazelcast.logging.type";
System.setProperty( logging, "log4j" );
/**if you want to give a new location. **/
System.setProperty( location, "file:/path/mylog4j.properties" );
```

Then set the log level to "Debug" in the properties file. Below is example content.

```
# direct log messages to stdout #
log4j.appender.stdout=org.apache.log4j.ConsoleAppender
log4j.appender.stdout.Target=System.out
log4j.appender.stdout.layout=org.apache.log4j.PatternLayout
log4j.appender.stdout.layout.ConversionPattern=%d{ABSOLUTE} %5p [%c{1}] - %m%n
log4j.logger.com.hazelcast=debug
#log4j.logger.com.hazelcast.cluster=debug
#log4j.logger.com.hazelcast.partition=debug
#log4j.logger.com.hazelcast.partition.InternalPartitionService=debug
#log4j.logger.com.hazelcast.nio=debug
#log4j.logger.com.hazelcast.hibernate=debug
```

The line `log4j.logger.com.hazelcast=debug` is used to see debug logs for all Hazelcast operations. Below this line, you can select to see specific logs (cluster, partition, hibernate, etc.).

---

---

## Client-server vs. embedded topologies?

In the embedded topology, members include both the data and application. This type of topology is the most useful if your application focuses on high performance computing and many task executions. Since application is close to data, this topology supports data locality.

In the client-server topology, you create a cluster of members and scale the cluster independently. Your applications are hosted on the clients and the clients communicate with the members in the cluster to reach data.

Client-server topology fits better if there are multiple applications sharing the same data or if application deployment is significantly greater than the cluster size (for example, 500 application servers vs. 10 member cluster).

---

## How can I shutdown a Hazelcast member?

Ways of shutting down a Hazelcast member:

- You can call `kill -9 <PID>` in the terminal (which sends a SIGKILL signal). This will result in the immediate shutdown which is not recommended for production systems. If you set the property `hazelcast.shutdownhook.enabled` to `false` and then kill the process using `kill -15 <PID>`, its result is the same (immediate shutdown).
- You can call `kill -15 <PID>` in the terminal (which sends a SIGTERM signal), or you can call the method `HazelcastInstance.getLifecycleService().terminate()` programmatically, or you can use the script `stop.sh` located in your Hazelcast's `/bin` directory. All three of them will terminate your member ungracefully. They do not wait for migration operations, they force the shutdown. But this is much better than `kill -9 <PID>` since it releases most of the used resources.
- In order to gracefully shutdown a Hazelcast member (so that it waits the migration operations to be completed), you have four options:
  - You can call the method `HazelcastInstance.shutdown()` programmatically.
  - You can use JMX API's shutdown method. You can do this by implementing a JMX client application or using a JMX monitoring tool (like JConsole).
  - You can set the property `hazelcast.shutdownhook.policy` to `GRACEFUL` and then shutdown by using `kill -15 <PID>`. Your member will be gracefully shutdown.
  - You can use the "Shutdown Member" button in the member view of [Hazelcast Management Center](#).

If you use systemd's `systemctl` utility, i.e., `systemctl stop service_name`, a SIGTERM signal is sent. After 90 seconds of waiting it is followed by a SIGKILL signal by default. Thus, it will call terminate at first and kill the member directly after 90 seconds. We do not recommend to use it with its defaults. But `systemd` is very customizable and well-documented, you can see its details using the command `man systemd.kill`. If you can customize it to shutdown your Hazelcast member gracefully (by using the methods above), then you can use it.

---

## How do I know it is safe to kill the second member?

Starting with Hazelcast 3.7, graceful shutdown of a Hazelcast member can be initiated any time as follows:

```
hazelcastInstance.shutdown();
```

Once a Hazelcast member initiates a graceful shutdown, data of the shutting down member is migrated to the other members automatically.

However, there is no such guarantee for termination.

Below code snippet terminates a member if the cluster is safe, which means that there are no partitions being migrated and all backups are in sync when this method is called.

```
PartitionService partitionService = hazelcastInstance.getPartitionService();
if (partitionService.isClusterSafe()) {
    hazelcastInstance.getLifecycleService().terminate();
}
```

Below code snippet terminates the local member if the member is safe to terminate, which means that all backups of partitions currently owned by local member are in sync when this method is called.

```
PartitionService partitionService = hazelcastInstance.getPartitionService();
if (partitionService.isLocalMemberSafe()) {
    hazelcastInstance.getLifecycleService().terminate();
}
```

Please keep in mind that two code snippets shown above are inherently racy. If member failures occur in the cluster after the safety condition check passes, termination of the local member can lead to data loss. For safety of the data, graceful shutdown API is highly recommended.



Please refer to [Safety Checking Cluster Members](#) for more information.

---

## When do I need Native Memory solutions?

Native Memory solutions can be preferred:

- when the amount of data per member is large enough to create significant garbage collection pauses.
- when your application requires predictable latency.

## Is there any disadvantage of using near-cache?

The only disadvantage when using Near Cache is that it may cause stale reads.

---

## Is Hazelcast secure?

Hazelcast supports symmetric encryption, transport layer security/secure sockets layer (TLS/SSL) and Java Authentication and Authorization Service (JAAS). Please see the [Security chapter](#) for more information.

---

## How can I set socket options?

Hazelcast allows you to set some socket options such as `SO_KEEPALIVE`, `SO_SNDBUF` and `SO_RCVBUF` using Hazelcast configuration properties. Please see `hazelcast.socket.*` properties explained in the [System Properties appendix](#).

---

## Client disconnections during idle time?

In Hazelcast, socket connections are created with the `SO_KEEPALIVE` option enabled by default. In most operating systems, default keep-alive time is 2 hours. If you have a firewall between clients and servers which is configured to reset idle connections/sessions, make sure that the firewall's idle timeout is greater than the TCP keep-alive defined in the OS.

For additional information please see:

- [Using TCP keepalive under Linux](#)
  - [Microsoft TechNet](#)
- 

## OOME: Unable to create new native thread?

If you encounter an error of `java.lang.OutOfMemoryError: unable to create new native thread`, it may be caused by exceeding the available file descriptors on your operating system, especially if it is Linux. This exception is usually thrown on a running member, after a period of time when the thread count exhausts the file descriptor availability.

The JVM on Linux consumes a file descriptor for each thread created. The default number of file descriptors available in Linux is usually 1024. If you have many JVMs running on a single machine, it is possible to exceed this default number.

You can view the limit using the following command.

```
# ulimit -a
```

At the operating system level, Linux users can control the amount of resources (and in particular, file descriptors) used via one of the following options.

---

1 - Editing the `limits.conf` file:

```
# vi /etc/security/limits.conf
```

```
testuser soft nofile 4096<br>
testuser hard nofile 10240<br>
```

2 - Or using the `ulimit` command:

```
# ulimit -Hn
```

```
10240
```

The default number of process per users is 1024. Adding the following to your `$HOME/.profile` could solve the issue:

```
# ulimit -u 4096
```

---

### Does repartitioning wait for Entry Processor?

Repartitioning is the process of redistributing the partition ownerships. Hazelcast performs the repartitioning in the cases where a member leaves the cluster or joins the cluster. If a repartitioning will happen while an entry processor is active in a member processing on an entry object, the repartitioning waits for the entry processor to complete its job.

---

### Instances on different machines cannot see each other?

Assume you have two instances on two different machines and you develop a configuration as shown below.

```
Config config = new Config();
NetworkConfig network = config.getNetworkConfig();

JoinConfig join = network.getJoin();
join.getMulticastConfig().setEnabled(false);
join.getTcpIpConfig().addMember("IP1")
    .addMember("IP2").setEnabled(true);
network.getInterfaces().setEnabled(true)
    .addInterface("IP1").addInterface("IP2");
```

When you create the Hazelcast instance, you have to pass the configuration to the instance. If you create the instances without passing the configuration, each instance starts but cannot see each other. Therefore, a correct way to create the instance is the following:

```
HazelcastInstance instance = Hazelcast.newHazelcastInstance(config);
```

The following is an incorrect way:

```
HazelcastInstance instance = Hazelcast.newHazelcastInstance();
```

## What Does "Replica: 1 has no owner" Mean?

When you start more members after the first one is started, you will see `replica: 1 has no owner` entry in the newly started member's log. There is no need to worry about it since it refers to a transitory state. It only means the replica partition is not ready/assigned yet and eventually it will be.

# Glossary

## 2-phase Commit

2-phase commit protocol is an atomic commitment protocol for distributed systems. It consists of two phases: commit-request and commit. In commit-request phase, transaction manager coordinates all of the transaction resources to commit or abort. In commit-phase, transaction manager decides to finalize operation by committing or aborting according to the votes of the each transaction resource.

## ACID

A set of properties (Atomicity, Consistency, Isolation, Durability) guaranteeing that transactions are processed reliably. Atomicity requires that each transaction be all or nothing (i.e. if one part of the transaction fails, the entire transaction will fail). Consistency ensures that only valid data following all rules and constraints is written. Isolation ensures that transactions are securely and independently processed at the same time without interference (and without transaction ordering). Durability means that once a transaction has been committed, it will remain so, no matter if there is a power loss, crash, or error.

## Cache

A high-speed access area that can be either a reserved section of main memory or storage device.

## Client Server Topology

Hazelcast topology where members run outside the user application and are connected to clients using client libraries. The client library is installed in the user application.

## Embedded Topology

| Hazelcast topology where the members are in-process with the user application and act as both client and server.

## **Garbage Collection**

Garbage collection is the recovery of storage that is being used by an application when that application no longer needs the storage. This frees the storage for use by other applications (or processes within an application). It also ensures that an application using increasing amounts of storage does not reach its quota. Programming languages that use garbage collection are often interpreted within virtual machines like the JVM. The environment that runs the code is also responsible for garbage collection.

## **Hazelcast Cluster**

A virtual environment formed by Hazelcast members communicating with each other in the cluster.

## **Hazelcast Partitions**

Memory segments containing the data. Hazelcast is built-on the partition concept, it uses partitions to store and process data. Each partition can have hundreds or thousands of data entries depending on your memory capacity. You can think of a partition as a block of data. In general and optimally, a partition should have a maximum size of 50-100 Megabytes.

## **IMDG**

An in-memory data grid (IMDG) is a data structure that resides entirely in memory and is distributed among many members in a single location or across multiple locations. IMDGs can support thousands of in-memory data updates per second and they can be clustered and scaled in ways that support large quantities of data.

## **Invalidation**

The process of marking an object as being invalid across the distributed cache.

## **Java heap**

Java heap is the space that Java can reserve and use in memory for dynamic memory allocation. All runtime objects created by a Java application are stored in heap. By default, the heap size is 128 MB, but this limit is reached easily for business applications. Once the heap is full, new objects cannot be created and the Java application shows errors.

## **LRU, LFU**

LRU and LFU are two of eviction algorithms. LRU is the abbreviation for Least Recently Used. It refers to entries eligible for eviction due to lack of interest by applications. LFU is the abbreviation for Least Frequently Used. It refers to the entries eligible for eviction due to having the lowest usage frequency.

## **Member**

A Hazelcast instance. Depending on your Hazelcast usage, it can refer to a server or a Java virtual machine (JVM). Members belong to a Hazelcast cluster. Members are also referred as member nodes, cluster members, or Hazelcast members.

## **Multicast**

A type of communication where data is addressed to a group of destination members simultaneously.



## **Near Cache**

A caching model. When Near Cache is enabled, an object retrieved from a remote member is put into the local cache and the future requests made to this object will be handled by this local member. For example, if you have a map with data that is mostly read, then using Near Cache is a good idea.

## **NoSQL**

"Not Only SQL". A database model that provides a mechanism for storage and retrieval of data that is tailored in means other than the tabular relations used in relational databases. It is a type of database which does not adhering to the traditional relational database management system (RDMS) structure. It is not built on tables and does not employ SQL to manipulate data. It also may not provide full ACID guarantees, but still has a distributed and fault tolerant architecture.

## **OSGI**

Formerly known as the Open Services Gateway initiative, it describes a modular system and a service platform for the Java programming language that implements a complete and dynamic component model.

## **Partition Table**

Table containing all members in the cluster, mappings of partitions to members and further metadata.

## **Race Condition**

This condition occurs when two or more threads can access shared data and they try to change it at the same time.

## **RSA**

An algorithm developed by Rivest, Shamir and Adleman to generate, encrypt and decrypt keys for secure data transmissions.

## **Serialization**

Process of converting an object into a stream of bytes in order to store the object or transmit it to memory, a database, or a file. Its main purpose is to save the state of an object in order to be able to recreate it when needed. The reverse process is called deserialization.

## **Split-brain**

Split-brain syndrome, in a clustering context, is a state in which a cluster of members gets divided (or partitioned) into smaller clusters of members, each of which believes it is the only active cluster.

## **Transaction**

Means a sequence of information exchange and related work (such as data store updating) that is treated as a unit for the purposes of satisfying a request and for ensuring data store integrity.